

LECTURE NOTES

For Medical Laboratory Students

<https://ismailpages.wordpress.com/>
<https://ismailawabdi.wordpress.com/health/>

Hematology



**Ethiopia Public Health
Training Initiative**

Yared Alemu, Alemayehu Atomsa,
Zewdneh Sahlemariam

Jimma University

In collaboration with the Ethiopia Public Health Training Initiative, The Carter Center, the
Ethiopia Ministry of Health, and the Ethiopia Ministry of Education

2006



Funded under USAID Cooperative Agreement No. 663-A-00-00-0358-00.

Produced in collaboration with the Ethiopia Public Health Training Initiative, The Carter Center, the Ethiopia Ministry of Health, and the Ethiopia Ministry of Education.

Important Guidelines for Printing and Photocopying

Limited permission is granted free of charge to print or photocopy all pages of this publication for educational, not-for-profit use by health care workers, students or faculty. All copies must retain all author credits and copyright notices included in the original document. Under no circumstances is it permissible to sell or distribute on a commercial basis, or to claim authorship of, copies of material reproduced from this publication.

©2006 by Yared Alemu, Alemayehu Atomsa, Zewdneh Sahlemariam

All rights reserved. Except as expressly provided above, no part of this publication may be reproduced or transmitted in any form or by any means, electronic or mechanical, including photocopying, recording, or by any information storage and retrieval system, without written permission of the author or authors.

This material is intended for educational use only by practicing health care workers or students and faculty in a health care field.

PREFACE

The lack of sufficient reference materials and uniformity in course syllabi has always been a problem in higher institutions in Ethiopia that are engaged in training health professionals including laboratory technologists. Hence, the authors hope that this lecture note would be immensely useful in solving this existing problem at significant level. The lecture note is intended for use by laboratory technologist both during their training and in their work places. There are twenty two chapters each beginning with specific learning objectives in which succeeding by a background of the topic in discussion. There are study questions at the end of each chapter for the reader to evaluate his understanding of the contents. In addition, important terms are defined in the glossary section at the end of the text.

ACKNOWLEDGEMENT

It is with sincere gratitude and pleasure that we acknowledge The Carter Center for the collaboration in preparation of this lecture note.

Special thanks are due to Mohammed Awole, Serkadis Debalke, Ibrahim Ali, Misganaw B/sellasiye, Abiye Shume, Shewalem Shifa and Simon G/tsadik for their assistance in reviewing and critiquing this material.

For her sustained devotion and extra effort, I express my deep gratitude and sincere appreciation to Zenaye Hailemariam, who has been most supportive with scrupulous attention and dedication in helping me throughout the preparation of this lecture note (Y.A).

Table of Contents

Preface	i
Acknowledgement	ii
Table of Contents	iii
Introduction	v
1. Blood.....	1
2. Blood Collection.....	42
3. Anticoagulants	61
4. Preparation of Blood Smears	67
5. Staining of Blood Smears	77
6. Hemocytometry	89
7. Differential Leucocyte Count.....	122
8. Reticulocyte Count.....	136
9. Hemoglobin.....	146
10. Packed Cell Volume	176
11. Red Cell Indices.....	188
12. Erythrocyte Sedimentation Rate	197

13. Osmotic Fragility of the Red Cell	209
14. Bone marrow smear examination	215
15. Lupus Erythematosus Cell.....	226
16. Red cell Morphology Study.....	232
17. Anemia.....	244
18. Hematological Malignancies.....	311
19. Leucocyte cytochemistry	339
20. Hemostasis.....	357
21. Body fluid analysis.....	434
22. Automation in Hematology.....	466
Glossary	477
References	567

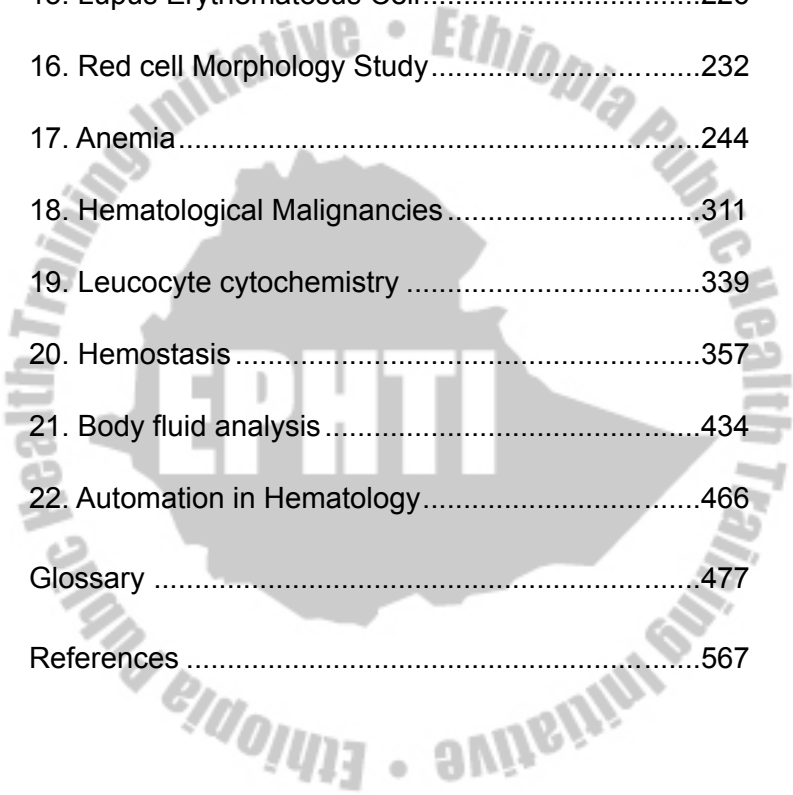

INTRODUCTION

The word hematology comes from the Greek haima (means blood) and logos (means discourse); therefore, the study of hematology is the science, or study, of blood. Hematology encompasses the study of blood cells and coagulation. Included in its concerns are analyses of the concentration, structure, and function of cells in blood; their precursors in the bone marrow; chemical constituents of plasma or serum intimately linked with blood cell structure and function; and function of platelets and proteins involved in blood coagulation.

The study of blood has a very long history. Mankind probably has always been interested in the blood, since primitive man realized that loss of blood, if sufficiently great, was associated with death. And in Biblical references, “to shed blood” was a term used in the sense of “to kill”.

Before the days of microscopy only the gross appearance of the blood could be studied. Clotted

blood, when viewed in a glass vessel, was seen to form distinct layers and these layers were perceived to constitute the substance of the human body. Health and disease were thought to be the result of proper mixture or imbalance respectively of these layers.

Microscopic examination of the blood by Leeuwenhoek and others in the seventeenth century and subsequent improvements in their rudimentary apparatus provided the means whereby theory and dogma would gradually be replaced by scientific understanding.

Currently, with the advancement of technology in the field, there are automated and molecular biological techniques enable electronic manipulation of cells and detection of genetic mutations underlying the altered structure and function of cells and proteins that result in hematologic disease.

CHAPTER ONE

BLOOD

Learning Objectives

At the end of this chapter, the student shall be able to:

- Explain the composition of blood
- Describe the function of blood
- Describe the formation of blood cells.
- Explain the regulatory mechanisms in hemopoiesis
- Indicate the sites of hemopoiesis in infancy, childhood and adulthood

.1 Composition blood

Blood is a circulating tissue composed of fluid plasma and cells. It is composed of different kinds of cells (occasionally called corpuscles); these formed elements of the blood constitute about 45% of whole blood. The other 55% is blood plasma, a fluid that is the blood's liquid medium, appearing yellow in color. The normal pH of human arterial blood is approximately 7.40 (normal range is 7.35-7.45), a weak alkaline solution. Blood is about 7% of the human body weight, so the average adult has a blood volume of about 5 liters, of which 2.7-3 liters is plasma. The combined surface area of all the red cells in the human body would be roughly 2000 times as great as the body's exterior surface.

Blood plasma

When the formed elements are removed from blood, a straw-colored liquid called plasma is left. Plasma is about 91.5% water and 8.5% solutes, most of which by weight (7%) are proteins.. Some of the proteins in plasma are also found elsewhere in the body, but those confined to blood are called plasma proteins. These proteins play a role in maintaining proper blood osmotic pressure, which is important in total body fluid balance. Most plasma proteins are synthesized by the liver,

Hematology

including the albumins (54% of plasma proteins), globulins (38%), and fibrinogen (7%). Other solutes in plasma include waste products, such as urea, uric acid, creatinine, ammonia, and bilirubin; nutrients; vitamins; regulatory substances such as enzymes and hormones; gasses; and electrolytes.

Formed elements

The formed elements of the blood are broadly classified as red blood cells (erythrocytes), white blood cells (leucocytes) and platelets (thrombocytes) and their numbers remain remarkably constant for each individual in health.

I. Red Blood Cells

They are the most numerous cells in the blood. In adults, they are formed in the marrow of the bones that form the axial skeleton. Mature red cells are non-nucleated and are shaped like flattened, bilaterally indented spheres, a shape often referred to as "biconcave disc" with a diameter 7.0-8.0 μm and thickness of 1.7-2.4 μm . In stained smears, only the flattened surfaces are observed; hence the appearance is circular with an area of central pallor corresponding to

the indented regions.

They are primarily involved in tissue respiration. The red cells contain the pigment hemoglobin which has the ability to combine reversibly with O_2 . In the lungs, the hemoglobin in the red cell combines with O_2 and releases it to the tissues of the body (where oxygen tension is low) during its circulation. Carbondioxide, a waste product of metabolism, is then absorbed from the tissues by the red cells and is transported to the lungs to be exhaled. The red cell normally survives in the blood stream for approximately 120 days after which time it is removed by the phagocytic cells of the reticuloendothelial system, broken down and some of its constituents re utilized for the formation of new cells.

II. White Blood Cells

They are a heterogeneous group of nucleated cells that are responsible for the body's defenses and are transported by the blood to the various tissues where they exert their physiologic role, e.g. phagocytosis. WBCs are present in normal blood in smaller number than the red blood cells ($5.0-10.0 \times 10^3/\mu\text{l}$ in adults). Their production is in the bone marrow and lymphoid tissues (lymph nodes, lymph nodules and spleen).

Hematology

There are five distinct cell types each with a characteristic morphologic appearance and specific physiologic role. These are:

- Polymorphonuclear leucocytes/granulocytes
 - Neutrophils
 - Eosinophils
 - Basophiles
- Mononuclear leucocytes
 - Lymphocytes
 - Monocytes

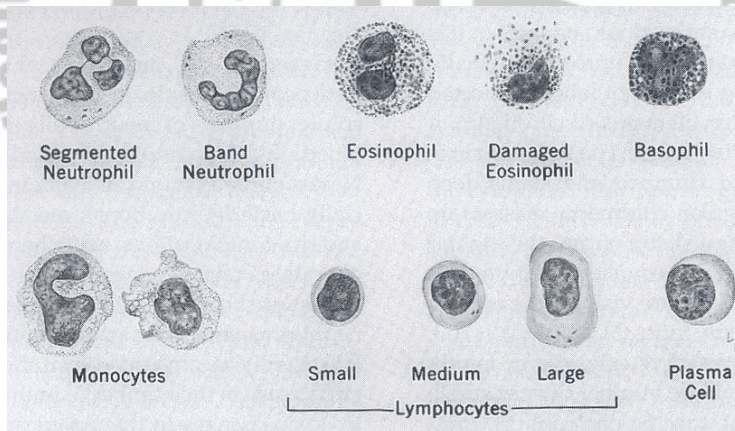

Fig. 1.1 Leucocytes

Polymorphonuclear Leucocytes

Polymorphonuclear Leucocytes have a single nucleus with a number of lobes. They contain small granules in their cytoplasm, and hence the name granulocytes. There are three types according to their staining reactions.

Neutrophils

Their size ranges from 10-12 μm in diameter. They are capable of amoeboid movement. There are 2-5 lobes to their nucleus that stain purple violet. The cytoplasm stains light pink with pinkish dust like granules. Normal range: $2.0-7.5 \times 10^3/\mu\text{l}$. Their number increases in acute bacterial infections.

Eosinophils

Eosinophils have the same size as neutrophils or may be a bit larger (12-14 μm). There are two lobes to their nucleus in a "spectacle" arrangement. Their nucleus stains a little paler than that of neutrophils. Eosinophils cytoplasm contains many, large, round/oval orange pink granules. They are involved in allergic reactions and in combating helminthic infections. Normal range: 40-400/ μl . Increase in their number (eosinophilia) is associated with allergic reactions and helminthiasis.

Basophils

Their size ranges from 10-12 μ m in diameter. Basophils have a kidney shaped nucleus frequently obscured by a mass of large deep purple/blue staining granules. Their cytoplasmic granules contain heparin and histamine that are released at the site of inflammation. Normal range: 20-200/ μ l. Basophilia is rare except in cases of chronic myeloid leukemia.

Mononuclear Leucocytes

Lymphocytes

There are two varieties:

➤ **Small Lymphocytes**

Their size ranges from 7-10 μ m in diameter. Small lymphocytes have round, deep-purple staining nucleus which occupies most of the cell. There is only a rim of pale blue staining cytoplasm. They are the predominant forms found in the blood.

➤ **Large Lymphocytes**

Their size ranges from 12-14 μ m in diameter.

Large lymphocytes have a little paler nucleus than small lymphocytes that is usually eccentrically placed in the cell. They have more plentiful cytoplasm that stains pale blue and may contain a few reddish granules. The average number of lymphocytes in the peripheral blood is 2500/ μ l. Lymphocytosis is seen in viral infections especially in children.

Monocytes

Monocytes are the largest white cells measuring 14-18 μ m in diameter. They have a centrally placed, large and 'horseshoe' shaped nucleus that stains pale violet. Their cytoplasm stains pale grayish blue and contains reddish blue dust-like granules and a few clear vacuoles. They are capable of ingesting bacteria and particulate matter and act as "scavenger cells" at the site of infection. Normal range: 700-1500/ μ l. Monocytosis is seen in bacterial infections. (e.g. tuberculosis) and protozoan infections.

III. Platelets

These are small, non nucleated, round/oval cells/cell fragments that stain pale blue and contain many pink granules. Their size ranges 1-4 μ m in diameter. They

are produced in the bone marrow by fragmentation of cells called megakaryocytes which are large and multinucleated cells. Their primary function is preventing blood loss from hemorrhage. When blood vessels are injured, platelets rapidly adhere to the damaged vessel and with one another to form a platelet plug. During this process, the soluble blood coagulation factors are activated to produce a mesh of insoluble fibrin around the clumped platelets. This assists and strengthens the platelet plug and produces a blood clot which prevents further blood loss. Normal range: $150-400 \times 10^3 /\mu\text{l}$.

1.2 Function of blood

Blood has important transport, regulatory, and protective functions in the body.

➤ **Transportation**

Blood transport oxygen from the lungs to the cells of the body and carbon dioxide from the cells to the lungs. It also carries nutrients from the gastrointestinal tract to the cells, heat and waste products away from cells and hormones from endocrine glands to other body cells.

➤ **Regulation**

Blood regulates pH through buffers. It also adjusts body temperature through the heat-absorbing and coolant properties of its water content and its variable rate of flow through the skin, where excess heat can be lost to the environment. Blood osmotic pressure also influences the water content of cells, principally through dissolved ions and proteins.

➤ **Protection**

The clotting mechanism protects against blood loss, and certain phagocytic white blood cells or specialized plasma proteins such as antibodies, interferon, and complement protect against foreign microbes and toxins.

1.3 Formation of blood cells

Hemopoiesis/hematopoiesis refers to the formation and development of all types of blood cells from their parental precursors. In postnatal life in humans, erythrocytes, granulocytes, monocytes, and platelets are normally produced only in the bone marrow. Lymphocytes are produced in the secondary lymphoid organs, as well as in the bone marrow and thymus gland. There has been much debate over the years as to the nature of hemopoiesis. Although many questions

Hematology

remain unanswered, a hypothetical scheme of hemopoiesis based on a monophyletic theory is accepted by many hematologists. According to this theory, the main blood cell groups including the red blood cells, white blood cells and platelets are derived from a pluripotent stem cell.

This stem cell is the first in a sequence of regular and orderly steps of cell growth and maturation. The pluripotent stem cells may mature along morphologically and functionally diverse lines depending on the conditioning stimuli and mediators (colony-stimulating factors, erythropoietin, interleukin, etc.) and may either:

- Produce other stem cells and self-regenerate maintaining their original numbers, or
- Mature into two main directions: stem cells may become committed to the lymphoid cell line for lymphopoiesis, or toward the development of a multipotent stem cell capable of granulopoiesis, erythropoiesis and thrombopoiesis.

During fetal life, hemopoiesis is first established in the yolk sac mesenchyme and later transfers to the liver and spleen. The splenic and hepatic contribution is gradually

Hematology

taken over by the bone marrow which begins at four months and replaces the liver at term. From infancy to adulthood there is progressive change of productive marrow to occupy the central skeleton, especially the sternum, the ribs, vertebrae, sacrum, pelvic bones and the proximal portions of the long bones (humeri and femurs).

Hemopoiesis occurs in a microenvironment in the bone marrow in the presence of fat cells, fibroblasts and macrophages on a bed of endothelial cells. An extracellular matrix of fibronectin, collagen and laminin combine with these cells to provide a setting in which stem cells can grow and divide. In the bone marrow, hemopoiesis occurs in the extravascular part of the red marrow which consists of a fine supporting reticulin framework interspersed with vascular channels and developing marrow cells. A single layer of endothelial cells separates the extravascular marrow compartment from the intravascular compartment. When the hemopoietic marrow cells are mature and ready to circulate in the peripheral blood, the cells leave the marrow parenchyma by passing through fine "windows" in the endothelial cells and emerge into the venous sinuses joining the peripheral circulation.

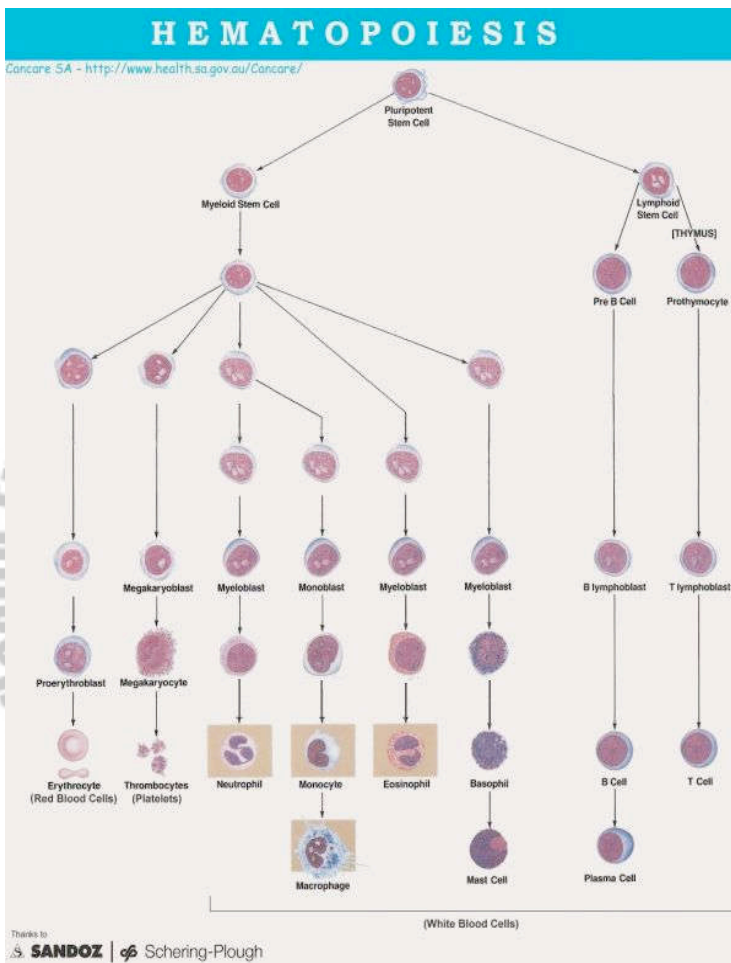

Fig. 1.2a Hematopoiesis

Hematology

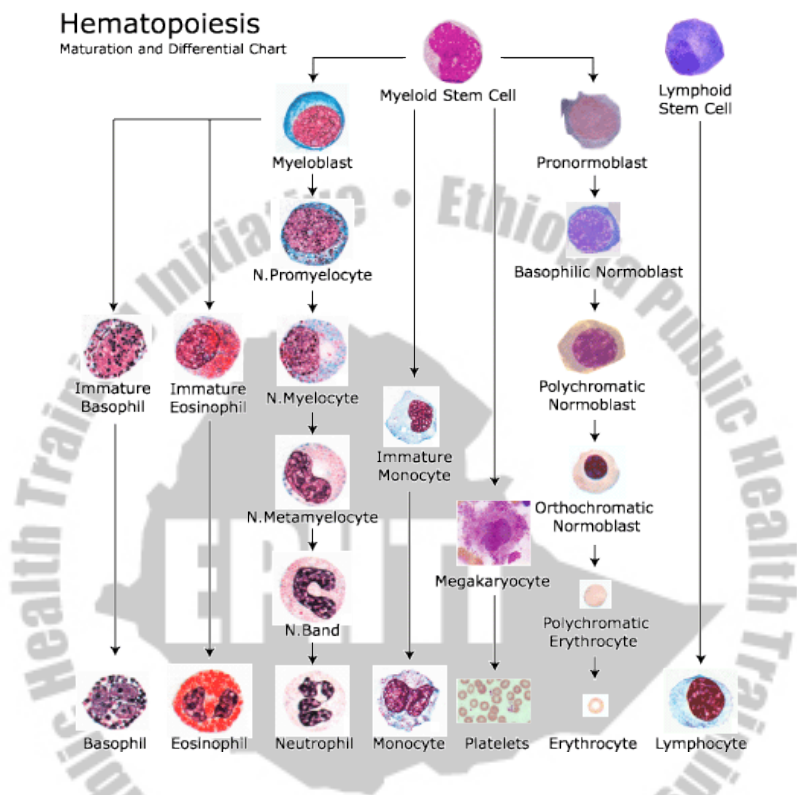

Fig. 1.2b Hematopoiesis

Hematopoietic Regulatory Factors

In general it can be stated that hemopoiesis is maintained in a steady state in which production of mature cells equals cell loss. Increased demands for cells as a consequence of disease or physiologic

change are met by increased cell production. Several hematopoietic growth factors stimulate differentiation along particular paths and proliferation of certain progenitor cells. Erythropoietin (EPO), a hormone produced mainly by the kidneys and in small amounts by the liver, stimulates proliferation of erythrocytes precursors, and thrombopoietin stimulates formation of thrombocytes (platelets). In addition, there are several different cytokines that regulate hematopoiesis of different blood cell types. Cytokines are small glycoproteins produce by red bone marrow cells, leucocytes, macrophages, and fibroblasts. They act locally as autocrines or paracrines that maintain normal cell functions and stimulate proliferation. Two important families of cytokines that stimulate blood cell formation are called colony stimulating factors (CSFs) and the interleukins. The classes of hematopoietic growth factors and their functions are described in Table 1.1.

Table 1.1 Hematopoietic growth factors

Hematology

Factor	Function
Stem Cell Growth Factor (Steel factor)	Stimulates pluripotent hematopoietic stem cells (hemocytoblasts)
Interleukin-3 (multi-CSF*)	Stimulates pluripotent hematopoietic stem cells and progenitors of eosinophils, neutrophils, basophils, monocytes, and platelets
Granulocyte-Macrophage CSF (GM-CSF)	Stimulates development of erythrocytes, platelets, granulocytes (eosinophils, neutrophils, and basophiles,), and monocytes.
Macrophage CSF (M-CSF)	Stimulates development of monocytes and macrophages
Granulocyte CSF (G-CSF)	Stimulates development of neutrophils
Interleukin-5	Stimulates development of eosinophils
Interleukin-7	Stimulates development of B lymphocytes

*CSF=Colony stimulating factor

Extramedullary Hemopoiesis

Organs that were capable of sustaining hemopoiesis in fetal life always retain this ability should the demand arise, e.g., in hemolytic anemias where there is an increased blood loss and an increased demand for red

blood cells. Also fatty marrow that starts to replace red marrow during childhood and which consists of 50% of fatty space of marrow of the central skeleton and proximal ends of the long bones in adults can revert to hemopoiesis as the need arises. Formation of apparently normal blood cells outside the confines of the bone marrow mainly in the liver and spleen in post fetal life is known as Extramedullary Hemopoiesis.

I. Formation of Red blood cells (Erythropoiesis)

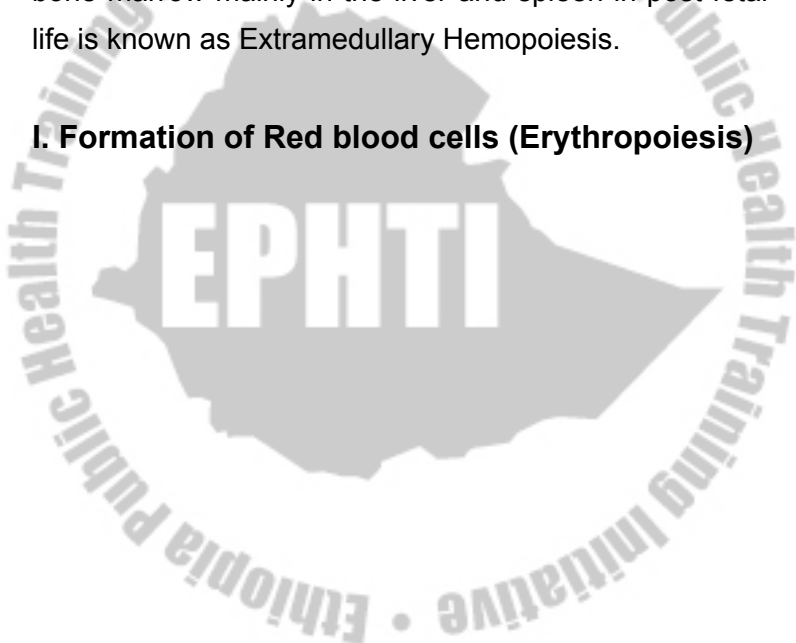

Hematology

Erythropoiesis is the formation of erythrocytes from committed progenitor cells through a process of mitotic growth and maturation. The first recognizable erythyroid cell in the bone marrow is the proerythroblast or pronormoblast, which on Wright or Giemsa stain is a large cell with basophilic cytoplasm and an immature nuclear chromatin pattern. Subsequent cell divisions give rise to basophilic, polychromatophilic, and finally orthochromatophilic normoblasts, which are no longer capable of mitosis. During this maturation process a progressive loss of cytoplasmic RNA occurs as the product of protein synthesis, hemoglobin, accumulates within the cell; as a result the color of the cytoplasm evolves from blue to gray to pink. At the same time the nuclear chromatin pattern becomes more compact and clumped until, at the level of the orthochromatophilic normoblast, there remains only a small dense nucleus, which is finally ejected from the cell. The resulting anucleate erythrocyte still contains some RNA and is recognizable as a reticulocyte when the RNA is precipitated and stained with dyes such as new methylene blue.

Normally, reticulocytes remain within the bone marrow for approximately 2 days as they continue to accumulate hemoglobin and lose some of their RNA. The reticulocyte then enters the peripheral blood, where, after about one more day, it loses its residual RNA and some of its excessive plasma membrane and becomes indistinguishable from adult erythrocytes. Under normal conditions the transit time from the pronormoblast to the reticulocyte entering the peripheral blood is about 5 days.

Morphology of the red cells and their precursors

A. Pronormoblast (Rubriblast)

Pronormoblast is the earliest morphologically recognizable red cell precursor.

Size: 20-25 μ m in diameter.

Nucleus: large, round to oval and contains 0-2 light bluish, indistinct nucleoli. The chromatin forms a delicate network giving the nucleus a reticular appearance.

Cytoplasm: there is a narrow (about 2 μ m) rim of dark blue cytoplasm. There may be a perinuclear halo. The nuclear/cytoplasm ratio is about 8:1.

B. Basophilic Normoblast

Size: 16-18 μ m in diameter.

Nucleus: round or oval and smaller than in the previous stage. The chromatin forms delicate clumps so that its pattern appears to be denser and coarser than that seen in the pronormoblast. No nucleoli are seen.

Cytoplasm: slightly wider ring of deep blue cytoplasm than in the pronormoblast and there is a perinuclear halo. The nuclear/cytoplasm ratio is about 6:1

C. Polychromatophilic Normoblast

Size: 12-14 μ m in diameter

Nucleus: smaller than in the previous cell, has a thick membrane, and contains coarse chromatin masses.

Cytoplasm: as the nucleus is shrinking the band of cytoplasm is widening. It has a lilac (polychromatic) tint because of beginning of hemoglobinization. The nuclear cytoplasmic ratio varies from 2:1 to 4:1.

D. Orthochromatic Normoblast

Size: 10-12 μ m in diameter.

Nucleus: small and central or eccentric with condensed homogeneous structure less chromatin. It is ultimately

lost by extrusion.

Cytoplasm: a wide rim of pink cytoplasm surrounds the shrinking nucleus. The entire cell is somewhat smaller than the polychromatophilic normoblast. The nuclear / cytoplasmic ratio varies from 1:2-1:3.

E. Reticulocyte

After the expulsion of the nucleus a large somewhat basophilic anuclear cell remains which when stained with new methylene blue, is seen to contain a network of bluish granules. This network is responsible for the name of the cell and consists of precipitated ribosomes. As the bone marrow reticulocyte matures the network becomes smaller, finer, thinner, and finally within 3 days disappears. About 1% of reticulocytes enter the peripheral circulation.

Size: 8-10 μ m in diameter

Nucleus: the reticulocyte does not contain a nucleus.

Cytoplasm: faintly basophilic (blue)

F. Mature erythrocyte

Size: 7-8 μ m in diameter

Cytoplasm: biconcave, orange-pink with a pale staining center occupying one-third of the cell area.

Regulation of Erythropoiesis

Erythropoietic activity is regulated by the hormone erythropoietin which in turn is regulated by the level of tissue oxygen. Erythropoietin is a heavily glycosylated hormone (40% carbohydrate) with a polypeptide of 165 aminoacids. Normally, 90% of the hormone is produced in the peritubular (juxtaglomerular) complex of the kidneys and 10% in the liver and elsewhere. There are no preformed stores of erythropoietin and the stimulus to the production of the hormone is the oxygen tension in the tissues (including the kidneys). When there is tissue airhypoxia due to:

- Low blood hemoglobin levels (e.g., anemia)
- Imped oxygen release from hemoglobin for some structural or metabolic defects (e.g., the hemoglobinopathies)
- Poor blood flow as in severe circulatory defects.
- Low atmospheric oxygen (e.g., high altitude)

Erythropoietin production increases and this stimulates erythropoiesis by increasing the number of progenitor cells committed to erythropoiesis.

Erythropoietin accelerates nearly every stage of red cell production:

- It increases the rate at which the committed stem cells divide and differentiate
- It increases the rate of cell division
- It speeds up the incorporation of iron into the developing red cells
- It shortens the time cell maturation, and
- It hastens the entry of reticulocytes into the peripheral circulation

Similarly, increased oxygen supply to the tissues due to:

- Increased red cell mass (e.g., polycythemia)
- Ability of hemoglobin to release oxygen to the tissues more readily than normal reduces the erythropoietin drive.

Ineffective erythropoiesis/Intramedullary hemolysis

Erythropoiesis is not entirely efficient since 10-15% of erythropoiesis in a normal bone marrow is ineffective, i.e., the developing erythroblasts die within the marrow without producing mature cells. Together with their hemoglobin, they are ingested by macrophages. This

process is substantially increased in a number of anemias.

Megaloblastic Erythropoiesis

Megaloblasts are pathologic cells that are not present in the normal adult bone marrow, their appearance being caused by a deficiency in vitamin B₁₂ or folic acid or both leading to defective DNA synthesis. In megaloblastic erythropoiesis, the nucleus and cytoplasm do not mature at the same rate so that nuclear maturation lags behind cytoplasmic hemoglobinization. This nuclear lag appears to be caused by interference with DNA synthesis while RNA and protein synthesis continue at a normal rate. The end stage of megaloblastic maturation is the megalocyte which is abnormally large in size (9-12 μ m in diameter).

II. Formation of white blood cells (Leucopoiesis)

Granulopoiesis and Monocytopoiesis

Neutrophils and monocytes, which evolve into macrophages when they enter the tissues, arise from a common committed progenitor. The myeloblast is the earliest recognizable precursor in the granulocytic series that is found in the bone marrow. On division the myeloblast gives rise to promyelocyte which contain

abundant dark “azurophilic” primary granules that overlie both nucleus and cytoplasm. With subsequent cell divisions these primary granules become progressively diluted by the secondary, less conspicuous “neutrophilic” granules that are characteristic of the mature cells. This concomitant cell division and maturation sequence continues from promyelocytes to early myelocytes, late myelocytes, and then metamyelocytes, which are no longer capable of cell division. As the metamyelocyte matures the nucleus becomes more attenuated and the cell is then called a “band” or “stab” form. Subsequent segmentation of the nucleus gives rise to the mature neutrophil or polymorphonuclear leucocyte. The average interval from the initiation of granulopoiesis to the entry of the mature neutrophil into the circulation is 10 to 13 days. The mature neutrophil remains in the circulation for only about 10 to 14 hours before entering the tissue, where it soon dies after performing its phagocytic function.

Neutrophil Granulocyte and Precursors

A. Myeloblast

Size and shape: the myeloblast is 20-25 μ m in diameter and has a round or oval shape.

Nucleus: large, oval or round, and eccentric. It has a thin nuclear membrane and finely dispersed, granular, purplish, pale chromatin with well-demarcated, pink, evenly distributed parachromatin: 2-5 light blue-gray nucleoli surrounded by dense chromatin are seen.

Cytoplasm: the cytoplasmic mass is small in comparison to the nucleus, producing a nuclear/cytoplasmic ratio of 7:1. It stains basophilic (bluish) and shows a small indistinct, paranuclear, lighter staining halo (golgi apparatus). The cytoplasm lacks granules.

B. Promyelocyte

Size and Shape: The promyelocyte is 15-20 μ m in diameter and round or oval in shape.

Nucleus: the nucleus is still large but is beginning to shrink. It is round or oval, eccentric, possibly slightly indented, and surrounded by a thin membrane. With in the finely of granular purplish pale chromatin, 1-3 nucleoli may be faintly visible.

Cytoplasm: It is pale blue; it is some what large in area than in myeloblast, so the nuclear/cytoplasmic ratio is 4:1 or 5:1. The basophilia is not quite as intense as in myeloblasts. The non-specific, peroxidase-containing

azurophilic granules are characteristic of the promyelocyte stage of development.

C. Myelocyte

Size and shape: 14-18 μ m in diameter and round.

Nucleus: Condensed, oval, slightly indented, and eccentric. The chromatin is coarse. Nucleoli are absent.

Cytoplasm: Light pink and contains neutrophilic granules (brownish) that may cover the nucleus and are coarse in the younger cells but become finer as the cell matures. The nuclear/cytoplasmic ratio is about 2:1 or 1:5:1.

D. Metamyelocyte (Juvenile cell)

The last cell of the granulocyte series capable of mitotic division; further stage in the development are caused by maturation and non-division.

Size and shape: 12-14 μ m in diameter and round.

Nucleus: Eccentric, condensed, and indented or kidney-shaped. The nuclear membrane is thick and heavy, and the chromatin is concentrated into irregular thick and thin areas.

Cytoplasm: abundant and pale or pink; it contains both specific and non-specific (few) granules that in the neutrophilic metamyelocytes vary in size, whereas the basophilic and eosinophilic granules are large and equal in size. The nuclear/cytoplasmic ratio is 1:1.

E. Band Granulocyte (Stab Cell)

The juvenile cell or the band cell are the youngest granulocytes normally found in the peripheral blood.

Size: 10-12 μ m in diameter

Nucleus: elongated, curved and usually U shaped, but it may be twisted. It is not segmented but may be slightly indented at one two points. The chromatin is continuous thick and coarse, and parachromatin is scanty.

Cytoplasm: contains specific and a few non-specific granules and is pink or colorless. The nuclear/cytoplasmic ratio is 1:2

F. Segmented granulocyte

Size: 10-12 μ m in diameter.

Nucleus: eccentric with heavy, thick chromatin masses.

It is divided into 2-5 lobes connected to each other by thin bridges of chromatin membrane. The ratio of segmented to band forms is of clinical significance and is normally about 10:1.

Cytoplasm: abundant and slightly eosinophilic (pinkish) or colorless and contains specific granules. The neutrophilic granules are very fine in texture and do not overlay the nucleus. The nuclear/cytoplasmic ratio is 1:2.

Eosinophilic Granulocyte and Precursors

Eosinophils mature in the same manner as neutrophils. The eosinophilic myeloblast is not recognizable as such. In the eosinophilic promyelocyte in the Wright-Giemsa stained preparation the granules are at first bluish and later mature into orange granules, which are larger than neutrophilic granules are round or ovoid and are prominent in the eosinophilic myelocyte.

Mature Eosinophil

Size and shape: 11-13 μ m in diameter, slightly larger than a segmented polymorphonuclear granulocyte.

Nucleus: usually bilobed, rarely single- or tri-lobed and

Hematology

contains dense chromatin masses.

Eosinophils with more than two nuclear lobes are seen in vitamin B₁₂ and folic acid deficiency and in allergic disorders.

Cytoplasm: densely filled with orange-pink granules so that its pale blue color can be appreciated only if the granules escape. The granules are uniform in size, large and do not cover the nucleus.

Basophilic Granulocyte and Precursors

The early maturation of the basophilic granulocyte is similar to that of the neutrophilic granulocyte.

Mature Basophil

Size: Somewhat smaller than eosinophils, measuring 10-12µm in diameter.

Nucleus: Indented giving rise to an S pattern. It is difficult to see the nucleus because it contains less chromatin and is masked by the cytoplasmic granules.

Cytoplasm: Pale blue to pale pink and contains granules that often overlie the nucleus but do not fill the cytoplasm as completely as the eosinophilic granules do.

Monocytes and their Precursors

Monoblast

Since the monoblast can not be differentiated from the myeloblast on morphologic or histochemical criteria, one may assume that the myeloblast can give rise to myeloid and monocytic cells.

Size: 15-25 μ m in diameter.

Nucleus: Round or oval and at times notched and indented. The chromatin is delicate blue to purple stippling with small, regular, pink, pale or blue parachromatin areas. The nucleoli (3-5 in number) are pale blue, large and round.

Cytoplasm: Relatively large in amount, contains a few azurophile granules, and stains pale blue or gray. The cytoplasm filling the nucleus indentation is lighter in color than the surrounding cytoplasm. The surrounding cytoplasm may contain Auer bodies.

Promonocyte

The earliest monocytic cell recognizable as belonging to the monocytic series is the promonocyte, which is capable of mitotic division. Its product, the mature

Hematology

monocyte, is only capable of maturation into a macrophage.

Size: 15-20 μ m in diameter.

Nucleus: Large, ovoid to round, convoluted, grooved, and indented. The chromatin forms a loose open network containing a few larger clumps. There may be two or more nucleoli.

Cytoplasm: sparse, gray-blue, contains fine azurophilic granules. The nuclear/cytoplasmic ratio is about 7:1

Monocyte

Size: 14-18 μ m in diameter.

Nucleus: Eccentric or central, is kidney shaped and often lobulated. The chromatin network consists of fine, pale, loose, linear threads producing small areas of thickening at their junctions. No nucleolus is seen. The overall impression is that of a pale nucleus quite variable in shape.

Cytoplasm: Abundant, opaque, gray-blue, and unevenly stained and may be vacuolated.

Lymphopoiesis

The precursor of the lymphocyte is believed to be the primitive multipotential stem cell that also gives rise to the pluripotential myeloid stem cell for the granulocytic, erythroid, and megakaryocytic cell lines. Lymphoid precursor cells travel to specific sites, where they differentiate into cells capable of either expressing cell-mediated immune responses or secreting immunoglobulins. The influence for the former type of differentiation in humans is the thymus gland; the resulting cells are defined as thymus-dependent lymphocytes, or T cells. The site of the formation of lymphocytes with the potential to differentiate into antibody-producing cells has not been identified in humans, although it may be the tonsils or bone marrow. In chickens it is the bursa of Fabricius, and for this reason these bursa-dependent lymphocytes are called B cells. B cells ultimately differentiate into morphologically distinct, antibody-producing cells called plasma cells

Lymphocytes and Precursors

Lymphoblast

Size: 15-20 μ m in diameter.

Nucleus: Central, round or oval and the chromatin has a stippled pattern. The nuclear membrane is distinct and

Hematology

one or two pink nucleoli are present and are usually well outlined.

Cytoplasm: Non-granular and sky blue and may have a darker blue border. It forms a thin perinuclear ring.

Prolymphocyte

Size: 14-18 μ m in diameter.

Nucleus: Oval but slightly indented and may show a faint nucleolus. The chromatin is slightly condensed into a mosaic pattern.

Cytoplasm: there is a thin rim of basophilic, homogeneous cytoplasm that may show a few azurophilic granules and vacuoles.

Lymphocytes

There are two varieties and the morphologic difference lies mainly in the amount of cytoplasm, but functionally most small lymphocytes are T cells and most large lymphocytes are B cells.

Small Lymphocyte

Size: 7-10 μ m in diameter.

Nucleus: round or oval to kidney shaped and occupies nine tenths of the cell diameter. The chromatin is dense and clumped. A poorly defined nucleolus may be seen.

Cytoplasm: It is basophilic and forms a narrow rim around the nucleus or at times a thin blue line only.

Large Lymphocyte

Size: 12-14 μ m in diameter

Nucleus: the dense, oval, or slightly indented nucleus is centrally or eccentricity located. Its chromatin is dense and clumped.

Cytoplasm: abundant, gray to pale blue, unevenly stained, and streaked at times. A few azurophilic granules are contained in 30-60% of the cells. These are large granular lymphocytes (LGLs).

III. Formation of platelets (Thrombopoiesis)

Platelets are produced in the bone marrow by fragmentation of the cytoplasm of megakaryocytes. The precursor of the megakaryocyte-the megakaryoblast-arises by a process of differentiation for the hemopoietic stem cell. The megakaryoblast produces megakaryocytes, distinctive large cell that are the

source of circulating platelets. Megakaryocyte development takes place in a unique manner. The nuclear DNA of megakaryoblasts and early megakaryocytes reduplicates without cell division, a process known as endomitosis.

As a result, a mature megakaryocyte has a polyploidy nucleus, that is, multiple nuclei each containing a full complement of DNA and originating from the same locus within the cell. Mature megakaryocytes are $8n$ to $36n$. The final stage of platelet production occurs when the mature megakaryocyte sends cytoplasmic projections into the marrow sinusoids and sheds platelets into the circulation. It takes approximately 5 days from a megakaryoblast to become a mature megakaryocyte. Each megakaryocyte produces from 1000 to 8000 platelets. The platelet normally survives for 7 to 10 days in the peripheral blood.

Morphology of the Platelets and their Precursors

Megakaryoblast

Size: ranges from $10-30\mu\text{m}$ in diameter. The cell is smaller than its mature forms but larger than all other blast cells.

Nucleus: the single, large, oval or indented nucleus has a loose chromatin structure and a delicate nuclear membrane. Multi-lobulated nuclei also occur representing a polyploid stage. Several pale blue nucleoli are difficult to see. The parachromatin is pink.

Cytoplasm: the cytoplasm forms a scanty, bluish, patchy, irregular ring around the nucleus. The periphery shows cytoplasmic projections and pseudopodia like structures.

The immediate perinuclear zone is lighter than the periphery.

Promegakaryocyte

Size: ranges from 20-50 μ m in diameter. It is larger than the megakaryoblast and in the process of maturation it reaches the size of the stage III cell.

Nucleus: large, indented and poly-lobulated. The chromatin appears to have coarse heavily stained strands and may show clumping. The total number of nucleoli is decreased and they are more difficult to see than in the blast cell. The chromatin is thin and fine.

Cytoplasm: intensely basophilic, filled with increasing

Hematology

numbers of azurophilic granules radiating from the golgi apparatus toward the periphery sparing a thin peripheral ring that remains blue in color.

Granular Megakaryocyte

The majority of the megakaryocytes of a bone marrow aspirate are in stage III which is characterized by progressive nuclear condensation and indentation and the beginning of platelet formation within the cytoplasm.

Size: ranges from 30-100 μ m in diameter and is the largest cell found in the bone marrow.

Cytoplasm: a large amount of polychromatic cytoplasm produces blunt, smooth, pseudopodia-like projections that contain aggregates of azurophilic granules surrounded by pale halos. These structures give rise to platelets at the periphery of the megakaryocytes.

Platelets

Size: varies from 1-4 μ m in diameter.

Nucleus: no nucleus is present.

In Wright - Giemsa stained films, platelets appear as

Hematology

small, bright azure, rounded or elongated bodies with a delicately granular structure.



Review Questions

1. What is hemopoiesis and how is the process regulated?
2. What are the hemopoietic tissues during fetal life, in infancy, in childhood and in adulthood?
3. What are the effects of the hormone erythropoietin on red cell development and maturation
4. Explain what megaloblastic erythropoiesis is.
5. State the main functions of blood.

CHAPTER TWO

BLOOD COLLECTION

Learning objectives

At the end of this chapter, the student shall be able to:

- List safety precautions considered in collecting blood samples
- List the possible source of blood samples for hematological investigation
- Describe the advantage of peripheral blood collection
- Explain the advantage and disadvantage of venous blood collection
- Describe the mechanism for preventing hemolysis

Introduction

Blood is the body fluid used most frequently for analytical purposes. Blood must be collected with care and adequate safety precautions to ensure test results are reliable, contamination of the sample is avoided and infection from blood transmissible pathogens is prevented. The proper collection and reliable

Hematology

processing of blood specimens is a vital part of the laboratory diagnostic process in hematology as well as other laboratory disciplines. Unless an appropriately designed procedure is observed and strictly followed, reliability can not be placed on subsequent laboratory results even if the test itself is performed carefully.

All material of human origin should be regarded as capable of transmitting infection. Specimens from patients suffering from, or at risk of, hepatitis or human immunodeficiency virus (HIV) infection require particular care. When collecting blood sample, the operator should wear disposable rubber gloves. The operator is also strongly advised to cover any cuts, abrasions or skin breaks on the hand with adhesive tape and wear gloves.

Care must be taken when handling especially, syringes and needles as needle-stick injuries are the most commonly encountered accidents. Do not recap used needles by hand. Should a needle-stick injury occur, immediately remove gloves and vigorously squeeze the wound while flushing the bleeding with running tap water and then thoroughly scrub the wound with cotton balls soaked in 0.1% hypochlorite solution. Used disposable syringes and needles and other sharp items such as

lancets must be placed in puncture-resistant container for subsequent decontamination or disposal.

Three general procedures for obtaining blood are (1) Skin puncture, (2) venipuncture, and (3) arterial puncture. The technique used to obtain the blood specimen is critical in order to maintain its integrity. Even so, arterial and venous blood differs in important respects. Arterial blood is essentially uniform in composition throughout the body. The composition of venous blood varies and is dependent on metabolic activity of the perfused organ or tissue. Site of collection can affect the venous composition. Venous blood is oxygen deficient relative to arterial blood, but also differs in pH, carbon dioxide concentration, and packed cell volume. Blood obtained by skin puncture is an admixture of blood from arterioles, venules, and capillaries. Increased pressure in the arterioles yields a specimen enriched in arterial blood. Skin puncture blood also contains interstitial and intracellular fluids.

2.1 Capillary blood collection

Capillary blood (peripheral blood / microblood samples)

is frequently used when only small quantities of blood are required, e.g., for hemoglobin quantitation, for WBC and RBC counts and for blood smear preparation. It is also used when venipuncture is impractical, e.g. in infants, in cases of severe burns, in extreme obesity where locating the veins could be a problem and in patients whose arm veins are being used for intravenous medication.

Sites of Puncture

- **Adults and children:** palmar surface of the tip of the ring or middle finger or free margin of the ear lobe.
- **Infants:** plantar surface of the big toe or the heel.

Note: Edematous, congested and cyanotic sites should not be punctured. Cold sites should not be punctured as samples collected from cold sites give falsely high results of hemoglobin and cell counts. Site should be massaged until it is warm and pink.

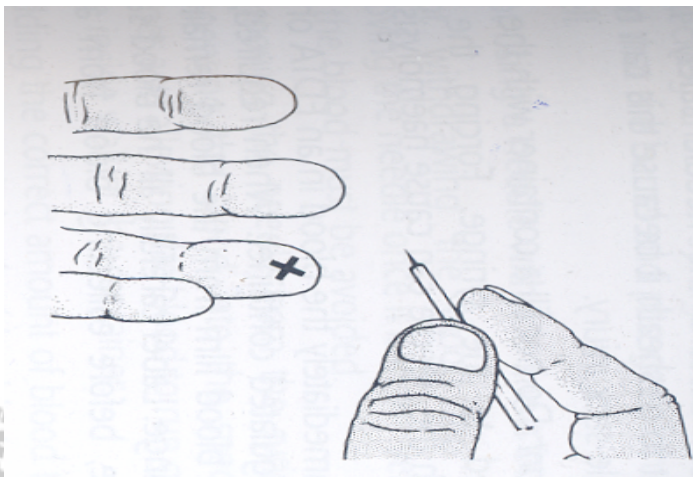

Fig 2.1 Peripheral blood collection from adult person

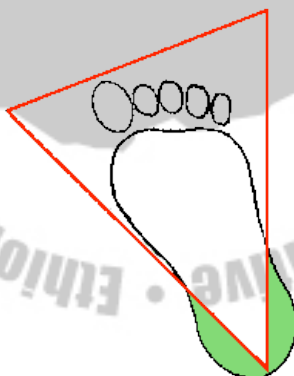

Fig 2.2 Skin puncture from infants

Materials Required

Gauze pads or cotton, 70% alcohol, sterile disposable lancet

Method

1. Rub the site vigorously with a gauze pad or cotton moistened with 70% alcohol to remove dirt and epithelial debris and to increase blood circulation in the area. If the heel is to be punctured, it should first be warmed by immersion in a warm water or applying a hot towel compress. Otherwise values significantly higher than those in venous blood may be obtained.
2. After the skin has dried, make a puncture 2-3mm deep with a sterile lancet. A rapid and firm puncture should be made with control of the depth. A deep puncture is no more painful than a superficial one and makes repeated punctures unnecessary. The first drop of blood which contains tissue juices should be wiped away. The site should not be squeeze or pressed to get blood since this dilutes it with fluid from the tissues. Rather, a freely flowing blood should be taken or a moderate pressure some distance above the puncture site is allowable.
3. Stop the blood flow by applying slight pressure with

a gauze pad or cotton at the site.

Advantages of Capillary Blood

- It is obtained with ease.
- It is the preferred specimen for making peripheral blood films since no anticoagulant is added that affect cell morphology.

Disadvantages of Capillary Blood

- Only small amounts of blood can be obtained and repeated examinations require a new specimen.
- Platelet count can not be performed on capillary blood since some platelets are unavoidably lost by adherence onto the wound.
- Precision is poorer in capillary than venous blood because of variation in blood flow and dilution with interstitial fluid.
- Blood in microtubes frequently hemolyses and hemolysis interferes with most laboratory tests.

2.2. Venous Blood Collection

A venous blood sample is used for most tests that require anticoagulation or larger quantities of blood,

plasma or serum.

Sites of Puncture

- The veins that are generally used for venipuncture are those in the forearm, wrist or ankle. The veins in the antecubital fossa of the arm are the preferred sites for venipuncture. They are larger than those in the wrist or ankle regions and hence are easily located and palpated in most people.
- The three main veins in the forearm are the cephalic, the median cephalic, and the median basilic.
- In infants and children, venipuncture presents special problems because of the small size of the veins and difficulty controlling the patient. Puncture of the external jugular vein in the neck region and the femoral vein in the inguinal area is the procedure of choice for obtaining blood.

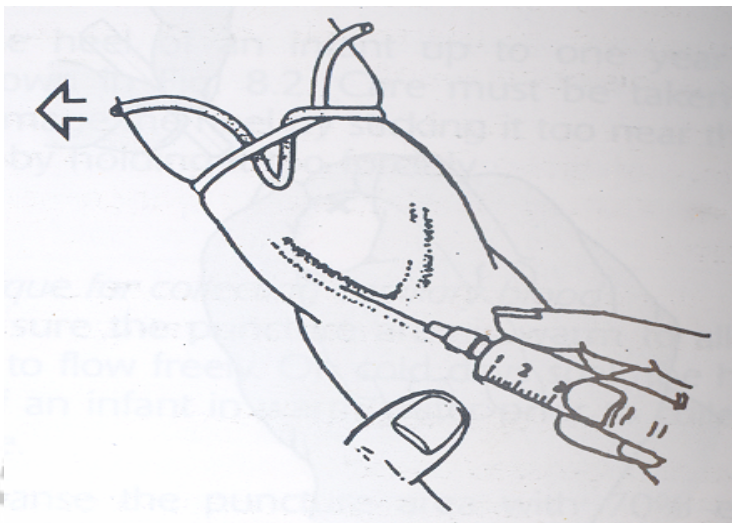

Fig 2.3 venipuncture

Materials

Sterile syringe and needle, vacuum tube, vacuum tube holder and two-way needle (if the vacutainer method is to be employed), tourniquet, gauze pads or cotton, 70% alcohol, test tubes with or without anticoagulant.

Method

1. Assemble the necessary materials and equipment.
 - Remove the syringe from its protective wrapper and the needle from the cap and assemble them allowing the cap to remain covering the needle

until use. Attach the needle so that the bevel faces in the same direction as the graduation mark on the syringe.

- Check to make sure the needle is sharp, the syringe moves smoothly and there is no air left in the barrel. The gauge and the length of the needle used depend on the size and depth of the vein to be punctured. The gauge number varies inversely with the diameter of the needle. The needle should not be too fine or too long; those of 19 or 21G are suitable for most adults, and 23G for children, the latter especially with a short shaft (about 15mm). The International Organization for standardization has established a standard (ISO 7864) with the following diameters for the different gauges: 19G=1.1mm; 21G=0.8mm; 23G=0.6mm.
- If the vacutainer method is to be used, thread the short end of the double-pointed needle into the holder and push the tube forward until the top of the stopper meets the guide mark on the holder. The point of the needle will thus be embedded in the stopper without puncturing it and losing the vacuum in the tube.

2. Identify the patient and allow him/her to sit

comfortably preferably in an armchair stretching his/her arm.

3. Prepare the arm by swabbing the antecubital fossa with a gauze pad or cotton moistened with 70% alcohol. Allow it to dry in the air or use a dry pad or cotton. The area should not be touched once cleaned.
4. Apply a tourniquet at a point about 6-8cm above the bend of the elbow making a loop in such a way that a gentle tug on the protruding ends will release it.
 - It should be just tight enough to reduce venous blood flow in the area and enlarge the veins and make them prominent and palpable.
 - The patient should also be instructed to grasp and open his/her fist to aid in the build up of pressure in the area of the puncture. Alternatively, the veins can be visualized by gently tapping the antecubital fossa or applying a warm towel compress.
5. Grasp the back of the patient's arm at the elbow and anchor the selected vein by drawing the skin slightly taut over the vein.
6. Using the assembled syringe and needle, enter the skin first and then the vein.
 - To insert the needle properly into the vein, the

Hematology

index finger is placed along side the hub of the needle with the bevel facing up. The needle should be pointing in the same direction as the vein.

- The point of the needle is then advanced 0.5-1.0cm into the subcutaneous tissue (at an angle of 45°) and is pushed forward at a lesser angle to pierce the vein wall. If the needle is properly in the vein, blood will begin to enter the syringe spontaneously. If not, the piston is gently withdrawn at a rate equal to the flow of blood.
 - With the vacutainer system, when in the vein, the vacuum tube is pushed into the needle holder all the way so that the blood flows into the tube under vacuum.
 - The tourniquet should be released the moment blood starts entering the syringe/vacuum tube since some hemoconcentration will develop after one minute of venous stasis.
7. Apply a ball of cotton to the puncture site and gently withdraw the needle. Instruct the patient to press on the cotton.
 8. With the syringe and needle system, first cover the needle with its cap, remove it from the nozzle of the

syringe and gently expel the blood into a tube (with or without anticoagulant).

- Stopper the tube and invert gently to mix the blood with the anticoagulant. The sample should never be shaken. With the vacutainer system, remove the tube from the vacutainer holder and if the tube is with added anticoagulant, gently invert several times.
 - Label the tubes with patient's name, hospital number and other information required by the hospital.
9. Reinspect the venipuncture site to ascertain that the bleeding has stopped. Do not let the patient go until the bleeding stops

Advantages of Venous Blood

- By providing sufficient amount of blood it allows various tests to be repeated in case of accident or breakage or for the all-important checking of a doubtful result. It also frequently allows the performance of additional tests that may be suggested by the results of those already ordered or that may occur to the clinician as afterthoughts.
- Aliquots of the specimen (plasma and serum)

may be frozen for future reference.

- It reduces the possibility of error resulting from dilution with interstitial fluid or constriction of skin vessels by cold that may occur in taking blood by skin puncture.

Disadvantages of Venous Blood

- It is a bit a lengthy procedure that requires more preparation than the capillary method.
- It is technically difficult in children, obese individuals and in patients in shock.
- Hemolysis must be prevented because it leads to lowered red cell counts and interferes with many chemical tests.
- Hematoma (or blood clot formation inside or outside the veins) must be prevented.

Difference between peripheral and venous Blood

Venous blood and peripheral blood are not quite the same, even if the latter is free flowing, and it is likely that free flowing blood obtained by skin puncture is more arteriolar in origin. The PCV, red cell count and hemoglobin content of peripheral blood are slightly greater than in venous blood. The total leucocyte and neutrophil counts are higher by about 8% and the

monocyte count by 12%. Conversely, the platelet count appears to be higher by about 9% in venous than peripheral blood. This may be due to adhesion of platelets to the site of the skin puncture.

Advantages of the Vacutainer Method of Venous Blood Collection

- It is an ideal means of collecting multiple samples with ease. The multiple sample needle used in the vacutainer method has a special adaptation that prevents blood from leaking out during exchange of tubes.
- The use of evacuated tube eliminates many of the factors that cause hemolysis.
- No preparation of anticoagulants and containers needed.
- One can choose among a wide range of tube size and contained anticoagulant.
- Because the evacuated tubes are sterile possible bacterial contamination is prevented and hence provides the ideal blood sample for microbiological analysis.

2.3. Arterial puncture

Arterial blood is used to measure oxygen and carbon

dioxide tension, and to measure pH (arterial blood gases-ABG). These blood gas measurements are critical in assessment of oxygenation problems encountered in patients with pneumonia, pneumonitis, and pulmonary embolism. Arterial punctures are technically more difficult to perform than venous punctures. Increased pressure in the arteries makes it more difficult to stop bleeding with the undesired development of a hematoma. Arterial selection includes radial, brachial, and femoral arteries in order of choice. Sites not to be selected are irritated, edematous, near a wound, or in an area of an arteriovenous (AV) shunt or fistula.

Prevention of Hemolysis

- Make sure the syringe, needle and test tubes are dry and free from detergent as traces of water or detergent cause hemolysis.
- Use smooth, good quality sharp needles.
- Gentleness should be the watch word. Avoid rough handling of blood at any stage. Do not eject the blood from the syringe through the needle as this may cause mechanical destruction of the cells. Transfer the blood from the syringe by gently ejecting down the side of the tube. Mix blood with

Hematology

anticoagulant by gentle inversion not by shaking.

- Tourniquet should not be too tight and should be released before blood is aspirated.
- If examination is to be delayed beyond 1-3 hrs, do not allow the sample to stand unsealed or at room temperature. Stopper and store in a refrigerator at 4°C. Blood should not be stored in a freezer because the red cells will hemolyse on thawing.
- Make sure that all solutions with which blood is to be mixed or diluted are correctly prepared and are isotonic. Hypotonic solutions will lead to hemolysis.
- When obtaining blood by skin puncture make sure the skin is dry before pricking and to use sharp, 2-3mm lancets that produce clean puncture wounds. The blood should be allowed to escape freely.

Review Questions

1. What are the sources of blood sample for hematological investigations?
2. What are the anatomical sites of collection in these sources in the different age groups?
3. What are the advantages as well as the draw backs of taking/using blood samples from each of these sources?
4. How do you minimize or avoid the occurrence of hemolysis in blood samples for hematological investigations?
5. What is the difference between samples collected from these two sources in terms of hematological parameters?

CHAPTER THREE

ANTICOAGULANTS

Learning objectives

At the end of this chapter, the student shall be able to:

- Define anticoagulants
- Describe the proportion, mechanism of anticoagulation and advantages of EDTA, Trisodium citrate, double oxalates and heparin anticoagulants.
- Prepare the different anticoagulants in the right concentration

Introduction

Anticoagulants are chemical substances that are added to blood to prevent coagulation. In other words, certain steps are involved in blood coagulation, but if one of the factors is removed or inactivated, the coagulation reaction will not take place. The substances responsible for this removal or inactivation are called anticoagulants. While clotted blood is desirable for certain laboratory investigations, most hematology procedures require an anticoagulated whole blood.

For various purposes, a number of different anticoagulants are available. EDTA and sodium citrate remove calcium which is essential for coagulation. Calcium is either precipitated as insoluble oxalate (crystals of which may be seen in oxalated blood) or bound in a non-ionized form. Heparin works in a different way; it neutralizes thrombin by inhibiting the interaction of several clotting factors in the presence of a plasma cofactor, antithrombin III. Sodium citrate or heparin can be used to render blood incoagulable before transfusion. For better long-term preservation of red cells for certain tests and for transfusion purposes, citrate is used in combination with dextrose in the form of acid-citrate-dextrose (ACD), citrate-phosphate-dextrose (CPD) or Alserver's solution.

3.1. Ethylenediamine tetraacetic acid

Ethylenediamine tetraacetic acid (EDTA) has become the standard hematology anticoagulant because of its very efficient and complete anticoagulation and its lack of effect on the size (morphology) or number of blood cells in the specimen. Its disodium or tripotassium salt are used. The anticoagulant recommended by the ICSH is the dipotassium salt. It is the preferred anticoagulant for cell counts and morphological studies. It is especially

the anticoagulant of choice for platelet counts and platelet function tests since it prevents platelet aggregation. It exerts its effect by tightly binding (chelating) ionic calcium thus effectively blocking coagulation. The dilithium salt of EDTA is equally effective as an anticoagulant, and its use has the advantage that the same sample of blood can be used for chemical investigation.

The amount of EDTA necessary for the complete chelation of Calcium is balanced with the desire to minimize cellular damage so that standardizing bodies have recommended a concentration of 1.5 ± 0.25 mg of Na_2 or K_3 EDTA per 1 ml of blood (e.g. 0.02 ml of 10% (W/V) solution of K_3 EDTA is used for 1 ml of blood). This concentration does not appear to adversely affect any of the erythrocyte or leucocyte parameters.

3.2 Trisodium Citrate

Sodium citrate combines with calcium, thereby preventing the conversion of prothrombin to thrombin, and coagulation does not occur. 100-120 mmol/l

trisodium citrate (32g/l) is the anticoagulant of choice in coagulation studies. Nine volumes of blood are added to 1 volume of the sodium citrate solution and immediately well mixed with it. Sodium citrate is also the anticoagulant for the erythrocyte sedimentation rate (ESR); for this, 4 volumes of venous blood are diluted with 1 volume of the sodium citrate solution.

3.3. Balanced or double oxalate

Salts of oxalic acid by virtue of their ability to bind and precipitate calcium as calcium oxalate serve as suitable anticoagulants for many hematologic investigations. Three parts of ammonium oxalate is balanced with two parts of potassium oxalate (neither salt is suitable by itself, i.e., ammonium oxalate causes cellular swelling and potassium oxalate causes erythrocyte shrinkage). It is used in the proportion of 1-2mg/ml of blood.

3.4. Heparin

Heparin is an excellent natural anticoagulant extracted from mammalian liver or pancreas. It is more expensive than the artificial ones and has a temporary effect of

Hematology

only 24 hours. Heparin prevents clotting by inactivating thrombin, thus preventing conversion of fibrinogen to fibrin. It is the best anticoagulant when absolute minimal hemolysis is required (e.g., osmotic fragility test and hematocrit determination). It is unsatisfactory for leucocyte and platelet and leucocyte counts as it causes cell clumping and also for blood film preparation since it causes a troublesome diffuse blue background in Wright-stained smears. It is used in the proportion of 0.1-0.2mg of the dry salt for 1ml of blood.

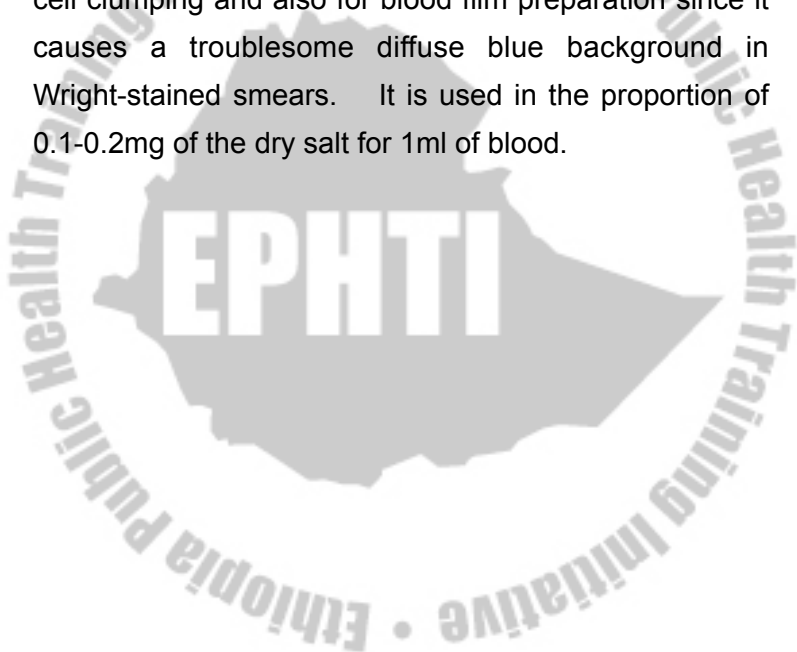

Review Questions

1. Define anticoagulant.
2. List the anticoagulants that are commonly used in hematology. How does each of these anticoagulants exert their functions?
3. Write the proportion of the volume of blood to the volume of each if these anticoagulants.

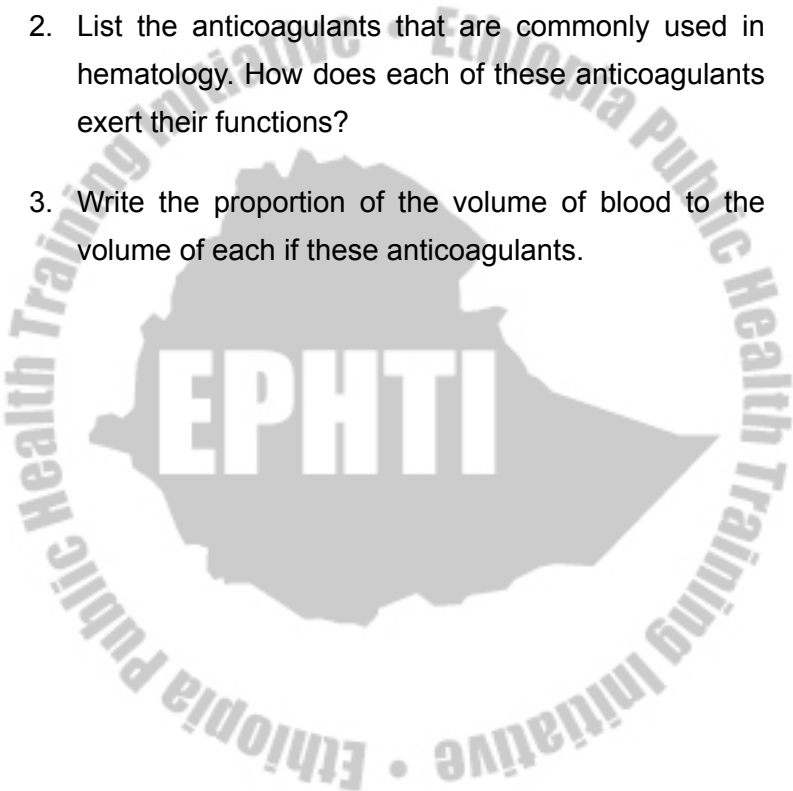

CHAPTER FOUR

PREPARATION OF BLOOD SMEARS

Learning objectives

At the end of this chapter, the student shall be able to:

- Explain the purpose of preparing blood films
- Prepare thin blood films on slides and cover glasses
- Explain the spinner method of preparing blood film
- Identify the desirable qualities of a thin blood film
- Prepare thick blood films

Microscopic examination of the peripheral blood is most often done by preparing, staining, and examining a thin film (smear) of blood on glass slide. A great deal of information can be obtained from the examination of a blood film. With the use of automatic counting devices that determine hemoglobin, hematocrit, red cell, white cell, and platelet counts together with MCV, MCH, MCHC, and RDW, white cell differential, and histograms, there is a tendency to place less emphasis on the routine examination of the peripheral blood film. However, these same automated results may also point

to the need to examine the blood film microscopically to confirm the presence of disease suggested by the results or for early detection of disease. Of course, in a laboratory without access to such automated information, the microscopic examination of the peripheral blood film is invaluable.

Examination of the blood film is an important part of the hematologic evaluation and the validity or reliability of the information obtained from blood film evaluation, the differential leucocyte count in particular depends heavily on well-made and well-stained films. While blood film preparation is a disarmingly simple straight-forward procedure, there is abundant and continuing evidence that the quality of blood films in routine hematology practice leaves much room for improvement. If not made from skin puncture, films should be prepared within 1 hour of blood collection into EDTA. Adequate mixing is necessary prior to film preparation if the blood has been standing for any appreciable period of time.

4.1 Preparation of thin blood films

Three methods of making films are described: the two-slide or wedge method, the coverglass method, and the

spinner method. Preparation of blood films on glass slides has the following advantages:

- Slides are not easily broken
- Slides are easier to label
- When large numbers of films are to be dealt with, slides will be found much easier to handle.

Method

I. Wedge method (Two-slide method)

- A small drop of blood is placed in the center line of a slide about 1-2cm from one end. Another slide, the spreading slide placed in front of the drop of blood at an angle of 30° to the slide and then is moved back to make contact with the drop. The drop will spread out quickly along the line of contact of the spreader with the slide.
- Once the blood has spread completely, the spreader is moved forward smoothly and with a moderate speed. The drop should be of such size that the film is 3-4cm in length (approx. $\frac{3}{4}$ th of the length of the slide). It is essential that the slide used as a spreader have a smooth edge and should be narrower in breadth than the slide on which the film is prepared so that the edges of the film can be readily examined.

Hematology

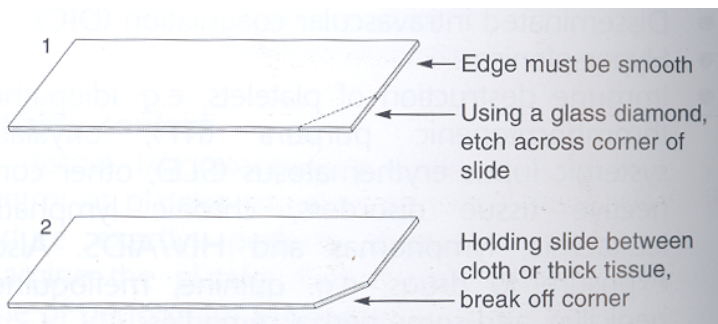

Fig 4.1 preparing a glass spreader to make blood films

- It can be prepared in the laboratory by breaking off 2mm from both corners so that its breadth is 4mm less than the total slide breadth. If the edges of the spreader are rough, films with ragged tails will result and gross qualitative irregularity in the distribution of cells will be the rule. The bigger leucocytes (neutrophils and monocytes) will accumulate in the margins and tail while lymphocytes will predominate in the body of the film.
- The ideal thickness of the film is such that there is some overlap of the red cells through out much of the film's length and separation and lack of distortion towards the tail of the film.
- Thickness and length of the film are affected by

speed of spreading and the angle at which the spreader slide is held. The faster the film is spread the thicker and shorter it will be. The bigger the angle of spreading the thicker will be the film.

- Once the slide is dry, the name of the patient and date or a reference number is written on the head of the film using a lead pencil or graphite. If these are not available, writing can be done by scratching with the edge of a slide. A paper label should be affixed to the slide after staining.

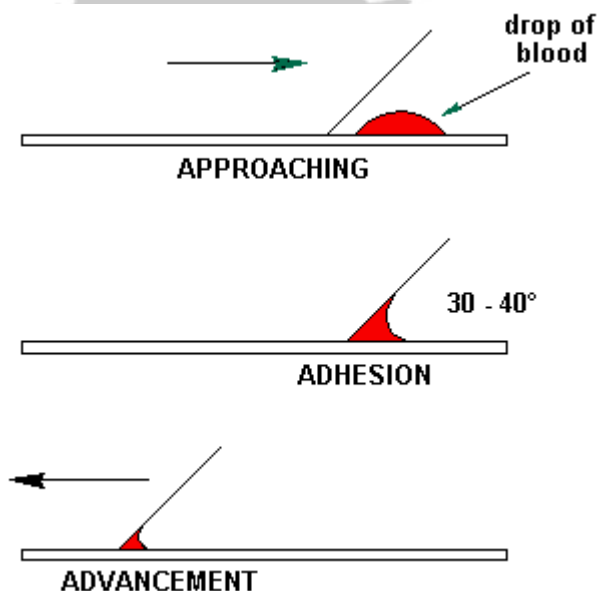

Fig 4.2 (a) Preparation of blood film

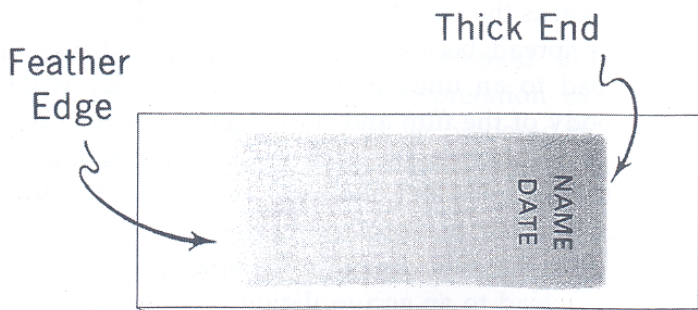

Fig 4.2 (b) Good blood film

II. Cover glass method

- 22mm × 22mm cover glasses are required.
- Touch a clean cover glass to the top of a small drop of blood without touching the skin and place it blood side down, cross-wise on another cover glass so that the corners will as an eight-pointed star. If the drop is not too large and if the cover glasses are perfectly clean, the blood will spread out evenly and quickly in a thin layer between the two surfaces.
- Cover glasses should be placed film side up on a clean paper and allowed to dry in the air. After they are stained they are mounted film side down with permount film side down on glass slides.

III. Spinner method

Blood films that combine the advantages of easy handling of the wedge slide and uniform distribution of cells of the coverglass preparation may be made with special types of centrifuges known as spinners. The spinner slide produces a uniform blood film, in which all cells are separated (a monolayer) and randomly distributed. White cells can be easily identified at any spot in the film. On a wedge smear there is a disproportion of monocytes at the tip of the feather edge, of neutrophils just in from the feather edge, and of both at the later edges of the film. This is of little practical significance, but it does result in slightly lower monocyte counts in wedge films.

Desirable qualities of a thin blood film

- The availability of sufficient working area.
- Acceptable morphology within working area and minimum distortion of the distribution of the blood cells in particular the leucocytes.
- Gradual transition to thickness from the thick to thin areas terminating in a feather like edge.
- No ridges, holes or waves.
- Margins of the film should be smooth, continuous and accessible for oil-immersion examination.
- The minimum length of the film should be 3.0cm

(approximately 3/4th of the length of the slide.

4.2. Preparation of thick blood smears

Thick blood smears are widely used in the diagnosis of blood parasites particularly malaria. It gives a higher percentage of positive diagnosis in much less time since it has ten times the thickness of normal smears. Five minutes spent in examining a thick blood film is equivalent to one hour spent in traversing the whole length of a thin blood film.

Method

Place a small drop of blood on a clean slide and spread it with an applicator stick or the corner of another slide until small prints are just visible through the blood smear. This corresponds to a circle of approximately 2cm diameter.

Review Questions

1. What is a thin blood film?
2. Which technique of blood film preparation is commonly employed and how is the method of preparation?
3. What are the desirable qualities of a thin blood film?
4. What are the possible effects of using a blood sample that has been standing at room temperature for some time on blood cell morphology?

CHAPTER FIVE

STAINING OF BLOOD SMEARS

Learning objectives

At the end of this chapter, the student shall be able to:

- Describe the general principle of staining blood films
- Perform the technique of staining thin blood films with Romanowsky dyes
- Describe the appearance of cells and cell components in Romanowsky-stained blood films
- Explain the principle of thick blood film preparation with Giemsa and Field's stains
- Stain blood films with the panoptic stains
- List the problems that arise in staining and the possible remedies

Introduction

Ehrlich was the first to use aniline dyes at first in sequence and latter as a premixed acidic – basic stains (neutral dyes). Jenner (1880) found that the precipitate formed when eosin and methylene blue are mixed could

be dissolved in methyl alcohol to form a useful stain combining certain properties of both parent dye stuffs. Romanowsky (1890) found that when old (ripened and therefore "polychromed") methylene blue solution is mixed with eosin and the precipitate dissolved in methyl alcohol, a stain results that has a wider range than Jenner's stain staining cell nuclei and platelet granules (which Jenner's mixture failed to stain).

5.1. Principle of staining

Acidic dyes such as eosin unites with the basic components of the cell (cytoplasm) and hence the cytoplasm is said to be eosinophilic (acidic). Conversely, basic stains like methylene blue are attracted to and combine with the acidic parts of the cell (nucleic acid and nucleoproteins of the nucleus) and hence these structures are called basophilic. Other structures stained by combination of the two are neutrophilic

5.2. Romanowsky stains in common use

Modern Romanowsky stains in common, e.g., Wright and Leishman, are basically similar to Romanowsky's original method, the difference being the method of polychroming the methylene blue.

I. Wright stain

In its preparation, the methylene blue is polychromed by heating with sodium carbonate. It is purchased as a solution ready to use or as a powder.

Staining Method

1. Place the air-dried smear film side up on a staining rack (two parallel glass rods kept 5cm apart).
2. Cover the smear with undiluted stain and leave for 1 minute. The methyl alcohol in the stain fixes the smear. When it is planned to use an aqueous or diluted stain, the air dried smear must first be fixed by flooding for 3-5 minutes with absolute methanol. If films are left unfixed for a day or more, it will be found that the background of dried plasma stains pale blue and this is impossible to remove without spoiling the staining of the blood cells.
3. Dilute with distilled water (approximately equal volume) until a metallic scum appears. Mix by

blowing. Allow this diluted stain to act for 3-5 minutes.

4. Without disturbing the slide, flood with distilled water and wash until the thinner parts of the film are pinkish red.

II. Leishman Stain

In its preparation, the methylene blue is polychromed by heating a 1 % solution with 0.5% sodium carbonate at 65°C for 12 hours after which a further ripening is allowed to proceed for 10 days before it is mixed with an equal volume of 0.1% eosin B.

Staining method

The method is similar to that used in Wright's stain except for step 3. With Leshman's stain, dilution is effected with approximately two volume of distilled water to one volume of stain (the best guide is the appearance of a metallic scum).

Microscopic appearance of cells and cell components in Romanowsky-stained blood films (Films stained with either Wright or Leishman stains are pinkish in color when viewed with the naked eye):

- Red cells - pink with a central pale area

Hematology

- Nuclei of leucocytes - blue to purple
- Cytoplasmic neutrophilic granules - tan
- Eosinophilic granules - red orange each distinctly discernible
- Basophilic granules - dark blue
- Cytoplasm of monocytes - faint blue gray
- Platelets - violet granules
- Malaria parasites - sky blue cytoplasm and red purple chromatin

III. Giemsa stain

Instead of empirically polychromed dyes, this stain employs various azure compounds (thionine and its methyl derivative) with eosin and methylene blue). This is an alcohol-based Romanowsky stain that required dilution in pH 7.1-7.2 buffered water before used. It gives the best staining of malaria parasites in thick films. It is commonly used in combination with Jenner or May – Grunwald stains it constitutes “panoptic staining”.

Staining of thick smears

The stains used employ the principle of destroying the red cells and staining leucocytes and parasites. The method using Giemsa stain is satisfactory.

Method

1. Cover the air-dried smear with a 1:10 diluted Giemsa using buffered distilled water at pH 6.8 as a diluent. Do not fix the films before staining. Leave the stain to act for 15-30 minutes. Do not fix the films before staining.
2. Wash with distilled water and air dry.

IV. Panoptic staining

Panoptic staining consists of a combination of a Romanowsky stain with another stain, e.g. Giemsa. This improves the staining of cytoplasmic granules and other bodies like nucleoli of blast cells. Popular methods are Jenner - Giemsa and May-Grunwald - Giemsa.

A. Jenner-Giemsa method

1. Dry the films in the air then fix by immersing in a jar containing methanol for 10-20 minutes. For bone marrow films leave for 20-25 minutes.
2. Transfer the films to a staining jar containing Jenner's stain freshly diluted with 4 volumes of buffered water and leave for 4 minutes.

Hematology

3. Transfer the slides without washing to a jar containing Giemsa stain freshly diluted with 9 volumes of buffered water pH 6.8. Allow to stain for 7-10 minutes.
4. Transfer the slides to a jar containing buffered water, pH 6.8; rapidly wash in 3 or 4 changes of water and finally allow to stand undisturbed in water for 2-5 minutes for differentiation to take place.
5. Place the slides on end to dry.

B. May-Grünwald-Giemsa method

1. Dry the films in the air then fix by immersing in a jar containing methanol for 10-20 minutes. For bone marrow films leave for 20-25 minutes.
2. Transfer the films to a staining jar containing May-Grünwald's stain freshly diluted with an equal volume of buffered water and leave for 15 minutes.
3. Transfer the slides without washing to a jar containing Giemsa's stain freshly diluted with 9 volumes of buffered water pH 6.8. Allow to stain for 10-15 minutes.
4. Transfer the slides to a jar containing buffered water, pH 6.8; rapidly wash in 3 or 4 changes of water and finally allow to stand undisturbed in water for 2-5 minutes for differentiation to take place.

5. Place the slides on end to dry.

V. Field's stain

Field's stain was introduced to provide a quick method for staining thick films for malaria parasites. It is a water-based Romanowsky stain composed of two solutions, Field's stain A and Field's stain B. It is buffered to the correct pH and neither solution requires dilution when staining thick films. When staining thin films, Field's stain B requires dilution. Compared with Giemsa working stain, Field's stains are more stable. They stain fresh blood films, well, particularly thick films. The rapid technique is ideally suited for staining blood films from waiting outpatients and when reports are required urgently.

Thin film Field's staining technique

Required

Field's stain A

Field's stain B, diluted 1 in 5

Buffered pH 7.1-7.2 water

Method

1. Place the slide on a staining rack and cover the methanol-fixed thin film with approximately 0.5ml of

diluted Field's stain B.

2. Add immediately an equal volume of Field's stain A and mix with the diluted Field's stain B. Leave to stain for 1 minute. The stain can be easily applied and mixed on the slide by using 1ml graduated plastic bulb pipettes.
3. Wash off the stain with clean water. Wipe the back of the slide clean and place it in a draining rack for the film to air-dry.

Thick film Field's staining technique

Required

Container of fields' stain A

Container of Field's stain B

Two containers of clean water (need not be buffered)

Method

1. Holding the slide with the dried thick film facing downwards, dip the slide into Field's stain A for 5 seconds. Drain off the excess stain by touching a corner of the slide against the side of the container.
2. Wash gently for about 5 seconds in clean water. Drain off the excess water.
3. Dip the slide into Field's stain B for 3 seconds. Drain off the excess stain.

4. Wash gently in clean water. Wipe the back of the slide clean and place it upright in a draining rack for the film to air-dry.

5.3 Problems in staining

I. Excessively blue stain

- **Causes:** too thick films, prolonged staining, inadequate washing, too high alkalinity of stain or diluent
- **Appearance:** erythrocytes-blue green, nuclear chromatin-deep blue to black, granules of neutrophils-deeply stained and appear large and prominent.
- **Correction:** preparing films with ideal thickness, reducing staining time, using less stain and more diluent, prolonging washing, adjust pH of buffer or prepare a new batch of stain.

II. Excessively pink stain

- **Causes:** insufficient staining, prolonged washing, too high acidity of the stain or buffer (exposure of stain or buffer to acid fumes).
- **Appearance:** erythrocytes-bright red or orange, nuclear chromatin-pale blue, granules of

eosinophils-sparkling brilliant red

- **Correction:** prolonging staining time, reducing washing, preparing a new batch of stain.

III. Precipitate on the film

- **Causes:** unclean slides, drying during the period of staining, inadequate washing of slide at the end of the staining period
- **Correction:** use clean slides, cover the smear with generous amount of the stain, wash the slide until thinner parts of the film are pinkish

Review Questions

1. What is the general principle of staining blood films with Romanowsky dyes?
2. What are the various Romanowsky stains used for staining of blood films?
3. Describe the appearance of cells and cell components in Romanowsky- stained thin blood films.
4. What are the staining problems that give rise to unsatisfactory results? How do you correct these problems?
5. What is panoptic staining? What is the advantage of panoptic stains over simple Romanowsky dyes?
6. What is the principle of thick film staining? List two dyes that are commonly used in thick blood film staining?

CHAPTER SIX

HEMOCYTOMETRY

Learning objectives

At the end of this chapter, the student shall be able to:

- Discuss the general principles of manual hemocytometry
- List the materials that are basically required in manual hemocytometry
- Identify the sources of error in manual hemocytometry
- Mention the diluting fluid, dilution factor and areas of counting on the chamber for the RBC, WBC, platelet and eosinophil count
- Perform RBC, WBC, platelet and eosinophil counts
- Discuss the clinical significance and normal values of each of the cell counts.

Introduction

Visual counting of blood cells is an acceptable

alternative to electronic counting for white cell and platelet counts. It is not recommended for routine red cell counts because the number of cells which can be counted within a reasonable time in the routine laboratory will be too few to ensure a precise result. Yet it is still necessary for the technologist to be able to use this method effectively and to know its limitations. Any cell counting procedure includes three steps: dilution of the blood, sampling the diluted suspension into a measured volume, and counting the cells in that volume.

The main principles for such examinations are:

- Selection of a diluting fluid that not only will dilute the cells to manageable levels but will either identify them in some fashion or destroy contaminant cellular elements.
- The use of a special glass counting chamber called hemocytometer that will present the cells to the observer in such a way that the number of cells per unit volume of fluid can be counted.

Counting Chambers

The hemocytometer is a thick glass slide with inscribed platforms of known area and precisely controlled depth under the coverslip. In the center of the upper surface

Hematology

there are ruled areas separated by moats/channels from the rest of the slide and two raised transverse bars one of which is present on each side of the ruled area. The ruled portion may be in the center of the chamber (single chamber) or there may be an upper and lower ruled portion (double chamber). The double chamber is to be recommended since it enables duplicate counts to be made rapidly.

When an optically plane cover glass is rested on the raised bars there is a predetermined gap or chamber formed between its lower surface and the ruled area (fig. 6.1). This is called the depth of the chamber and it varies with the type of the chamber. The ruled area itself is divided by microscopic lines into a pattern that varies again with the type of the chamber.

The counting chamber recommended for cell counts is a metallized surface (Bright-line) double cell Improved Neubauer ruled chamber. Non-metallized hemocytometer are less expensive, but they are not recommended. It is more difficult to count WBCs reliable using this type of chamber because the background rulings and cells are not as easily seen. Not-metallized chambers are also more difficult to fill.

Although there are a number of hemocytometer, it is the improved Neubauer counting chamber which is used for most routine cell counts:

I. Ordinary Neubauer counting chamber

The central platform is set 0.1mm below the level of the two side ones, giving the chamber a depth of 0.1mm. The engraving covers an area of 9mm² divided into 9 squares of 1mm² each. The 4 corner squares are divided into 16 squares, each with an area of 1/16 of a mm². The central ruled area of 1mm² is divided into 16 large squares by sets of triple lines. These large squares are further subdivided into 16 small squares by single lines. The width of the triple lines dividing the large squares is the same as the width of a small square. Two adjacent sides of the ruled area are bounded by triple lines, the other two by single lines. Each side is, therefore, divided into 20 equal divisions (the width of 16 small squares and 4 sets of triple lines). Each small square is, therefore, 1/20 of 1mm squared that is 1/400 of 1mm².

II. The Improved Neubauer Counting Chamber

The depth between the lower surface of the cover glass which is on the raised bars and the ruled area is 0.1mm.

Hematology

Each ruled area is a square of 9mm divided into nine large squares each of 1mm side. The central square of these nine is divided by engraved lines into 400 tiny squares of arranged in 25 groups of 16 by triple boundary lines. Each large square is 1mm^2 , each of the 25 medium squares is of 0.04mm^2 area and each of the 400 tiny squares has an area of 0.0025mm^2 .

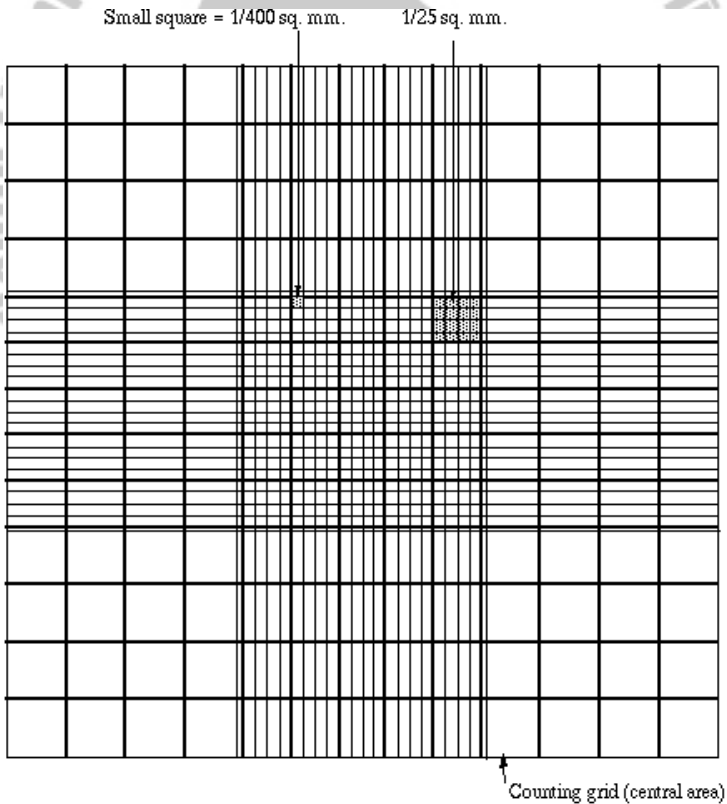

Fig. 6.1a Improved Neubauer ruled counting chamber.

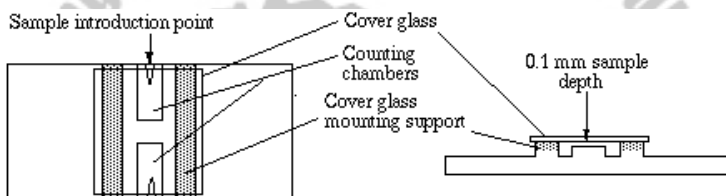

Fig. 6.1b: View of the improved Neubauer counting chamber

III. Fuchs-Rosenthal counting chamber

This chamber was originally designed for counting cells in cerebrospinal fluid, but as such a relatively large area is covered, it is preferred by some workers for counting leucocytes. The depth is 0.2mm and the ruled area consists of 16mm squares divided by triple lines. These squares are subdivided to form 16 smaller squares, each with an area of $1/16$ of 1mm^2 (figure 6.2). Another type of Fuchs-Rosenthal chamber is now available,

which has the same depth as the one described, but is ruled over 9mm^2 only.

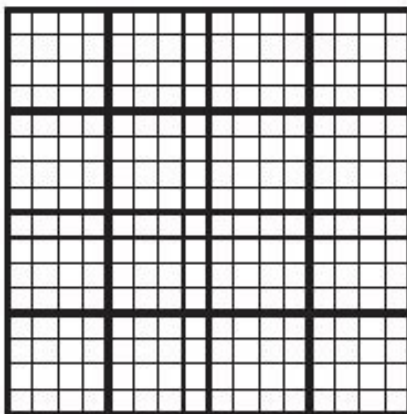

Fig. 6.2: Fuchs-Rosenthal counting chamber

IV. Burker ruled counting chamber

Like the Neubauer counting chamber, this has a ruled area of 9mm^2 and a depth of 0.1mm . To count white cells using Burker Chamber, the four large corner squares are used (4mm^2) and the same calculation as describe for the Improved Neubauer ruled chamber is used.

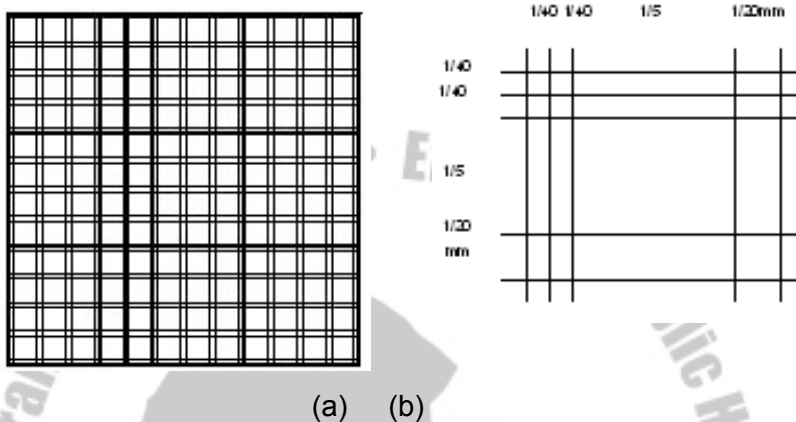

Fig. 6.3 (a) Ruled area of the Burkler counting chamber;
(b) enlarged view showing actual measurements.

Dilution of the Sample

Dilution of sample is accomplished by using either a thomma pipette or the tube dilution method. With tubes larger volumes of blood and diluting fluid are used and the greater will be the accuracy as compared with the smaller volumes used in the thomma pipette techniques. Thomma pipettes are small calibrated diluting pipettes designed for either white cell or red cell count.

Counting and Calculation

The diluted cells are introduced into the counting chamber and allowed to settle. They are then counted in

the designated area (s). Cells lying on or touching the upper or left boundary lines are included in the count while those on the lower and right boundary lines are disregarded.

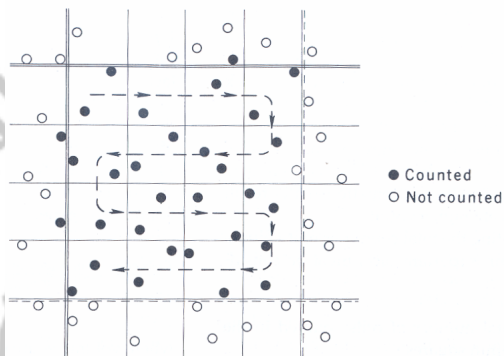

Fig 6.4 Examples of white blood cells counted in a representative area.

Calculation

$$\text{No. of cells/mm}^3 = \frac{N \times DF}{A \times d}; \quad \text{No. of cells/l} = \frac{N \times DF \times 10^6}{A \times d}$$

- Where, N = no. of cells counted in a given area
- DF = dilution factor
- A = area of counting in mm²
- d = depth of the counting chamber
(Volume of chamber = A × d)

6.1 White blood cell count

A white blood cell count (total leucocyte count – TLC) is used to investigate infections and unexplained fever and to monitor treatments which can cause leucopenia. In most situations when a total WBC count is requested it is usual to perform also a differential WBC count. EDTA anticoagulated blood or capillary blood can be used for counting white cells. Heparin or sodium citrate anticoagulated blood must not be used.

Principle

Whole blood is diluted 1 in 20 an acid reagent which hemolyzes the red cells (not the nucleus of nucleated red cells), leaving the white cells to be counted. White cells are counted microscopically using an Improved Neubauer ruled counting chamber (hemocytometer) and the number of WBCs per liter of blood calculated. When after examining a stained blood film, many nucleated red cells are present (more than 10%), the WBC count should be corrected.

Diluting Fluid

Turk's solution - 2% aqueous solution of acetic acid

colored pale violet with gentian violet or pale blue with methylene blue. The glacial acetic acid causes erythrocyte lysis while the gentian violet lightly stains the leucocytes permitting easier enumeration.

Test method

Thomma White Cell Pipette

The long stem is divided into 10 equal parts with “0.5” and “1” engraved on it. On the short limb just above the bulb, the mark “11” is engraved. When blood is drawn up to the 0.5 mark and diluent to the 11 mark, the sample of blood (now in the bulb) is diluted 1:20. Once the pipette accurately filled to the mark, the rubber suction (or mouth piece) is carefully removed, with the pipette held horizontally and only one finger sealing the tip. Both ends of the pipette may then be sealed with special small rubber sealing caps or with the middle finger on the tip and the thumb on the other end. The pipette is shaken mechanically or manually for 2 minutes. A bead contained in the bulb of the pipette aids in the mixing. If shaking is done manually, the shaking motions should be varied and alternated.

The cover glass is placed on the chamber and a slight pressure applied to the ends of the cover glass until a

Hematology

“rain bow” or Newton’s diffraction rings are revealed on either side. Once the diluted blood in the pipette has been thoroughly mixed, a few drops are expelled to discard the cell-free diluting fluid in the long stem of the pipette. With the index finger forming a controlled seal over the end of the pipette, which is held at an angle of 45° , the tip of the pipette is brought up to the edge of the cover glass and by gentle release of index finger pressure, fluid is allowed to run out slowly until the counting platform is covered.

The fluid is drawn into the chamber by capillary attraction. Care must be taken not to overfill the chamber which will result in overflow into the channels. If blood is diluted with the tube technique (in which $20\mu\text{l}$ of blood is taken with a sahli pipette and mixed with 0.38ml of diluting fluid in a small tube). Charging is accomplished by using disposable capillary tubes or long stem Pasteur pipettes. The chamber is placed in position on the microscope stage and is allowed to stand for 2 or 3 minutes so that the cells will settle.

All apparatus should be cleaned thoroughly after each use. Pipettes (thomma and sahli) should be washed well with a sequence of water and acetone (filled with

each fluid three or four times) and air drawn after the acetone until the inside of the pipette is thoroughly dry. Pipettes should be periodically cleaned with potassium dichromate cleaning solution or hydrogen peroxide. Hemocytometers should be washed in distilled water immediately after use and dried with gauze or tissue paper. They should be stored in such a way as to avoid breakage and scratching of the counting surface.

Performance of the Count

The counting chamber is surveyed with the low power objective to ascertain whether the cells are evenly distributed. Then the number of cells in four large squares is counted.

Calculation

If N is the number of leucocytes in four large squares, then the number of cells per mm³ is given by:

$$\text{No. of leucocytes/mm}^3 = \frac{N \times DF}{\text{Vol.}}$$

Where N is the number of leucocytes in an area of 4mm²

DF is the dilution factor equal to 20

Vol. is the total volume on which the count is

Hematology

done and is given by the total area of count multiplied by the depth of the chamber (0.1mm for the improved Neubauer counting chamber).

Substituting these values in the above formula:

$$\text{No. of leucocytes/mm}^3 = N \times 50, \quad N \geq 100^*$$

* 100 cells is a reasonable and practical figure for visual counts. When the leucocyte count is low (below $4.0 \times 10^3/\text{mm}^3$), it is advisable for greater accuracy to use a 1:10 dilution, i.e., take blood to the "1" mark of the pipette and diluting fluid to the 11 mark.

The corrected leucocyte count

Nucleated red cells will be counted and can not be distinguished from leucocytes in the total leucocyte count. If their number is high as seen on the stained smear, a correction should be made according to the following formula:

Hematology

$$\text{Corrected leucocyte count} = \frac{\text{Uncorrected count} \times 100}{\text{No. of NRBC} + 100}$$

- Where the **No. of NRBC** is the number of nucleated red cells which are counted during the enumeration of 100 leucocytes in the differential count.

Example

The blood smear shows 25 nucleated red cells per 100 white cells in the differential count. The total leucocyte count is 10,000/mm³. Calculate the true leucocyte count.

Tube method

1. Measure 0.38ml of diluting fluid and dispense into a small container or tube.
2. Add 20 μ l (0.02ml, 20cmm) of well-mixed EDTA anticoagulated venous blood or free-flowing capillary blood and mix.
3. Assemble the counting chamber.
4. Re-mix the diluted blood sample. Using a capillary, Pasteur pipette, or plastic bulb pipette held at an angle of about 45⁰C, fill one of the grids of the chamber with the sample, taking care not to overfill the area.

Hematology

5. Leave the chamber undisturbed for 2 minutes to allow time for the white cells to settle.
 6. Count as described in thomma white cell count method
- * When a count is higher than $50 \times 10^9/l$, repeat the count using 0.76ml of diluting fluid and 20 μ l of blood. When a count is lower than $2 \times 10^9/l$, repeat the count using 0.38ml of diluting fluid and 40 μ l of blood.

Sources of error in manual WBC counts

- Incorrect measurement of blood due to poor technique or using a wet or chipped pipette.
- When using anticoagulated blood, not mixing the blood sufficiently or not checking the sample for clots.
- Inadequate mixing of blood with diluting fluid.
- Not checking whether the chamber and cover glass are completely clean.
- Not using a hemocytometer cover glass
- Over-filling a counting chamber or counting cells when the sample contains air-bubbles.
- Not allowing sufficient time (2 minutes) for the cells to settle in the chamber.
- Using too intense a light source or not reducing

the iris diaphragm sufficiently to give good contrast (poor focusing and difficulty in seeing clearly the cells and ruling are common when using non-metallized hemocytometers).

- Not completing counting of the cells before the sample begins to dry in the chamber.
- Counting too few cells. Precision increases with the number of cells counted.
- Not correcting a count when the sample contains many nucleated RBCs.

Interpretation of WBC count

Reference ranges for white cell counts vary with age with higher counts being found in children. There are also gender differences with higher total WBC and neutrophil counts being found in women of child-bearing age and during pregnancy. Counts also vary in different populations with lower total WBC and neutrophil counts being found in Africans and people of African descent. Total leucocyte counts are commonly increased in infections and when considered along with the differential leucocyte count can be indicators as to whether the infecting agent is bacterial or viral.

WBC reference range

Children at 1 y	6.0 – 18.0 x 10 ⁹ /l
Children 4-7 y	5.0 – 15.0 x 10 ⁹ /l
Adults	4.0 – 10.0 x 10 ⁹ /l
Adults of African origin	2.6 – 8.3 x 10 ⁹ /l
Pregnant women	Up to 15 x 10 ⁹ /l

Leucocytosis

The main causes of a raised WBC count are:

- Acute infections
e.g. pneumonia, meningitis, abscess, whooping cough, tonsillitis, acute rheumatic fever, septicemia, gonorrhoea, cholera, septic abortion. Acute infections in children can cause a sharp rise in WBC count.
- Inflammation and tissue necrosis
e.g. burns, gangrene, fractures and trauma, arthritis, tumors, acute myocardial infarction.
- Metabolic disorders
e.g. eclampsia, uremia, diabetic coma and acidosis.
- Poisoning
e.g. chemicals, drugs, snake venoms
- Acute hemorrhage
- Leukemias and myeloproliferative disorders
- Stress, menstruation, strenuous exercise.

Leucopenia

The main causes of a reduced WBC count are:

- Viral, bacterial, parasitic infections
e.g. HIV/AIDS, viral hepatitis, measles, rubella, influenza, rickettsial infections, overwhelming bacterial infections such as miliary tuberculosis, relapsing fever, typhoid, paratyphoid, brucellosis, parasitic infections including leishmaniasis and malaria.
- Drugs e.g., chloramphenicol, phenylbutazone,
- Ionizing radiation
- Production failure as in aplastic anemia, megaloblastic anemia
- Anaphylactic shock

6.2. Red Cell Count

Although red cell counts are of diagnostic value in only a minority of patients suffering from blood diseases, the advent of electronic cell counters has enormously increased the practicability of such counts. Their value, too, has been increased now that they can be done with a degree of accuracy and reproducibility comparable to that for hemoglobin estimation. Although clearly an

Hematology

obsolete method (because the combined error of dilution and enumeration is high), visual counting will still have to be undertaken for some years to come in the smaller laboratories.

Principle

A sample of blood is diluted with a diluent that maintains (preserves) the disc-like shape of the red cells and prevents agglutination and the cells are counted in a Neubauer or Burker counting chamber.

Diluting Fluid

1% formal citrate

Dilution

Thomma Red Cell Pipette

Take a well mixed blood or blood from a freely flowing capillary puncture to the "0.5" mark of the pipette and diluent to the "101" mark. Blood will be diluted 1:200.

Tube Dilution

Take 20 μ l blood with sahli pipette and mix it with 4ml diluent in a small tube to give a final dilution of 1:201

Counting and Calculation

After the suspension is charged into the chamber and the cells allowed to settle, cells should be counted using the 40× objective and 10× eyepiece in 5 small squares of the central 1mm² area of the improved Neubauer counting chamber (4 corner and 1 central squares each with an area of 0.04mm²). If the Burker counting chamber is used, the count is done in 3 (3mm × 0.05mm) area. It is important to count as many cells as possible for the accuracy of the count is increased thereby; 500 cells should be considered as the absolute minimum.

Calculation

- No. of RBC/mm³ = $N \times 10,000$ for $N \geq 500$ (Improved Neubauer counting chamber). If the number of RBC in the five small squares is less than 500, then the whole 1mm² central area should be counted.
- No. of RBC = $N \times 4440$ (Burker counting chamber)

Normal Values

Adults:

Hematology

Men: $4.5-6.2 \times 10^6/\text{mm}^3$

Women: $4.0-5.5 \times 10^6/\text{mm}^3$

Infants and children:

at birth: $4.0-6.0 \times 10^6/\text{mm}^3$

first 3 months: $4.0-5.5 \times 10^6/\text{mm}^3$

3 months – 3 years: $4.0-5.2 \times 10^6/\text{mm}^3$

3 years – 10 years: $4.0-5.0 \times 10^6/\text{mm}^3$

Significance of Results

Together with the hematocrit and hemoglobin values it can be used to calculate the red cell indices which provide a valuable guide to the classification of anemias and diagnosis of polycythemia.

6.3 Platelet Count

A platelet count may be requested to investigate abnormal skin and mucosal bleeding which can occur when the platelet count is very low. Platelet counts are also performed when patients are being treated with cytotoxic drugs or other drugs which may cause thrombocytopenia.

Many methods for counting platelets have been described and their number is doubtless due to real difficulties in counting small fragments which can assume various shapes, which agglutinate and break up easily and which are difficult to distinguish from extraneous matter. The introduction of EDTA as a routine anticoagulant with its ability to inhibit platelet aggregation has to some extent resolved the problem of aggregate formation and the use of phase contrast microscope facilitates platelet identification.

I. Method using formal-citrate red cell diluent

Diluent should be prepared using thoroughly clean glassware and fresh distilled water. The solution should be filtered before use.

Method

1. Make a 1:100 dilution of a well mixed EDTA-anticoagulated blood using a red cell thomma pipette (blood to the "1" mark and diluent to the "101" mark) or by adding 20 μ l of blood to 2ml diluent in a clean glass tube. EDTA venous blood is preferred to

capillary blood since some platelets are unavoidably lost from the latter because they adhere to the edges of the wound and this favors falsely low values.

2. Mix for 2 minutes on a mechanical mixer or manually. Then fill a Neubauer counting chamber and allow the platelets to settle for 20 minutes. To prevent drying of the fluid, place the chamber in a petri dish or plastic container on dampened tissue or blotting paper and cover with a lid.
3. Count the number of platelets which will appear as small refractile bodies in the central 1mm^2 area with the condenser racked down.

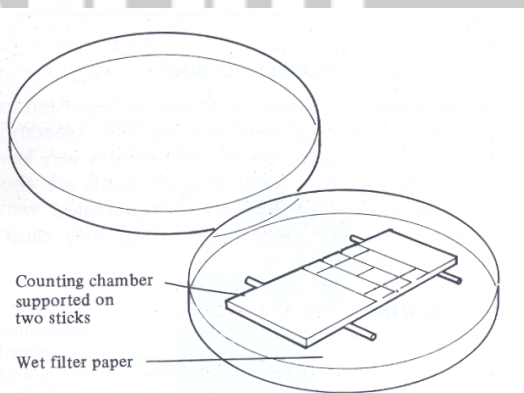

Fig 6.5 Counting chamber in Petri dish to prevent drying of the preparation

Calculation No. of platelets/mm³ = $N \times 1000$, $N \geq 100^*$

* The total platelets counted should exceed 100. If the count is less than 100, it is preferable to repeat the count with a lesser dilution of blood.

Disadvantage of the Method

Platelets may be obscured by overlying red cells.

II. Method Using Ammonium Oxalate (10g/l; 1%w/v)

This diluent causes erythrocyte lysis. Not more than 500ml should be prepared at a time using thoroughly clean glassware and fresh distilled water. The solution should be filtered and kept at 4°C. Always refilter the fluid before use.

Method

A 1:20 dilution of blood is made using either a WBC thomma pipette or the tube dilution technique. The preparation is mixed, the chamber filled and the cells allowed to settle in a similar fashion as Method 1. The cells are counted in 5 small squares in the central 1mm² of the improved Neubauer counting chamber.

Calculation No. of platelets/mm³ = $N \times 1000$, $N \geq 100$

Disadvantage of the Method

Possibility of mistaking red cell debris for platelets

III. Rough estimation of platelet number from a stained blood film

Normally there are 10-20 platelets per oil immersion field.

Sources of error in counting platelets

Sources of error when counting platelets are similar to those mentioned previously for WBC counts. Special care must be taken when counting platelets:

- To check there are not clots in the blood sample.
- To ensure the blood is well mixed with the diluting fluid.
- Not to mistake debris forms hemolyzed red cells or particles in the diluting fluid for platelets.
- To ensure the platelets are evenly distributed and not in small clumps (if clumps are present, obtain a new blood sample).
- Not to use too intense an illumination.

Interpretation of platelet counts

In health there are about $150-400 \times 10^9$ platelets/liter of blood. Platelet counts from capillary blood are usually

lower than from venous blood and are not as reproducible. Platelet counts are lower in Africans. The platelet count together with other tests (e.g. bleeding time test, prothrombin time, etc) aids in establishing a diagnosis of coagulation disorders.

Thrombocytosis

Causes of an increase in platelet numbers include:

- Chronic myeloproliferative disease e.g. essential thrombocythemia, polycythemia vera, chronic myeloid leukemia, myelofibrosis.
- Carcinoma (disseminated)
- Chronic inflammatory disease, e.g. tuberculosis
- Hemorrhage
- Sickle cell disease associated with a non-functioning spleen or after splenectomy.
- Iron deficiency anemia, associated with active bleeding

Thrombocytopenia

The main causes for a reduction in platelet numbers are:

I. Reduced production of platelets

- Infections, e.g. typhoid and other septicemias
- Deficiency of folate or vitamin B₁₂
- Aplastic anemia

Hematology

- Drugs (e.g. cytotoxic, quinine, aspirin), chemicals (e.g. benzene), some herbal remedies.
- Leukemias, lymphoma, myeloma, myelofibrosis, carcinoma.
- Hereditary thrombocytopenia

II. Increased destruction or consumption of platelets

- Infections, e.g. acute malaria, dengue, trypanosomiasis, visceral leishmaniasis
- Disseminated intravascular coagulation (DIC)
- Hypersplenism
- Immune destruction of platelets, e.g. idiopathic thrombocytopenic purpura (ITP), systemic lupus erythematosus (SLE), other connective tissue disorders, chronic lymphatic leukemia, lymphomas and HIV/AIDS. Also, exposure to rugs, e.g. quinine, mefloquine, penicillin, and some herbal remedies.

6.4 Eosinophil Count

Although total eosinophil count can be roughly calculated from the total and differential leucocyte count, the staining properties of eosinophils make it possible to count them directly and accurately in a counting

chamber.

Principle

Blood is diluted with a fluid that causes lysis of erythrocytes and stains eosinophils rendering them readily visible.

Diluting Fluid

Hinkleman's fluid

It has the advantage of keeping well at room temperature and not needing filtering before use.

Method

Make dilution of blood using thomma pipette or tube dilution as described for the white cell count. A Fuchs-Rosenthal chamber (with a total area of 16mm^2 and depth of 0.2mm) is used and counting is carried out as soon as they are settled. Usually 10 minutes in a moist atmosphere petridish will suffice. All the cells in the ruled area are counted (i.e., in $3.2\mu\text{l}$ volume).

Calculation

If E is the number of eosinophils in 16 large squares (in $3.2\mu\text{l}$ volume), then the absolute eosinophil count per μl

Hematology

of blood is:

$$\text{Absolute eosinophil count} = \frac{E \times 20}{3.2}; [6.25E]$$

To increase the accuracy at least 100 cells should be counted, i.e., both ruled areas should be counted and if the count is low, the chamber should be cleaned and refilled, average counts per ruled area being used for the calculation.

Reference range

$$40 - 440 \times 10^6/l$$

Interpretation of eosinophil counts

Eosinophilia is common in allergic conditions (e.g., asthma) and in parasitic infections.

Review Questions

1. What are the main principles of manual hemocytometry?
2. List the items that are generally required in manual hemocytometry?
3. How do you calculate the number of cells per unit volume of blood after you count the cells in a sample of diluted blood?
4. How do errors in hemocytometry arise? How do you reduce the introduction of such errors in your count?
5. Indicate the diluting fluid, dilution factor, and areas of counting on the chamber for WBC, RBC, platelet and eosinophil count
6. Briefly describe the clinical implications of each of the WBC, RBC, platelet and eosinophil count

CHAPTER SEVEN

DIFFERENTIAL LEUCOCYTE COUNT

Learning objectives

At the end of this chapter, the student shall be able to:

- Explain what differential count is
- Perform differential leucocyte count
- Explain the advantage and disadvantage of doing the differential count with different methods
- Discuss the methods of reporting differential leucocyte count
- Discuss the clinical implication of the differential leucocyte count

Introduction

Differential leucocyte count (DLC) is the enumeration of the relative proportions (percentages) of the various types of white cells as seen on stained films of peripheral blood. The count is usually performed by visual examination of blood films which are prepared on slides by the wedge technique. For a reliable differential

count the film must not be too thin and the tail of the film should be smooth.

To achieve this, the film should be made using a smooth glass spreader. This should result in a film in which there is some overlap of the red cells diminishing to separation near the tail and in which the white cells on the body of the film are not too badly shrunken. If the film is too thin or if a rough-edged spreader is used, 50% of the white cells accumulate at the edges and in the tail and gross qualitative irregularity in distribution will be the rule. The polymorphonuclear leucocytes and monocytes predominate at the edges while much of smaller lymphocytes are found in the middle.

Methods of Counting

Various systems of performing the differential count have been advocated. The problem is to overcome the differences in distribution of the various classes of cells which are probably always present to a small extent even in well made films. Of the three methods indicated underneath for doing the differential count, the lateral strip method appears to be the method of choice because it averages out almost all of the disadvantages of the two other methods. Multiple manual registers or

electronic counters are used for the count.

I. The Longitudinal Strip Method

The cells are counted using the X40 dry or X100 oil immersion objectives in a strip running the whole length of the film until 100 cells are counted. If all the cells are counted in such a strip, the differential totals will approximate closely to the true differential count.

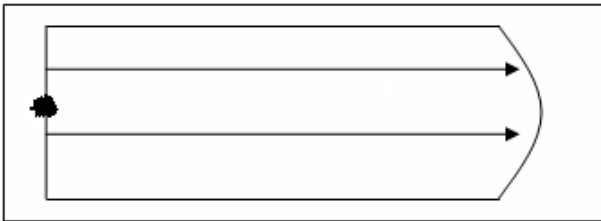

Fig. 7.1: The longitudinal strip method of differential counting

Disadvantages of the Method

- Difficulty in identifying contracted heavily stained cells in the thicker parts of the film.
- It does not allow for any excess of neutrophils and monocytes at the edges of the film but this

preponderance is slight in a well made film and in practice little difference to results.

II. The Exaggerated Battlement Method

In this method, one begins at one edge of the film and counts all cells, advancing inward to one-third the width of the film, then on a line parallel to the edge, then out to the edge, then along the edge for an equal distance before turning inward again. At least 100 cells should be counted.

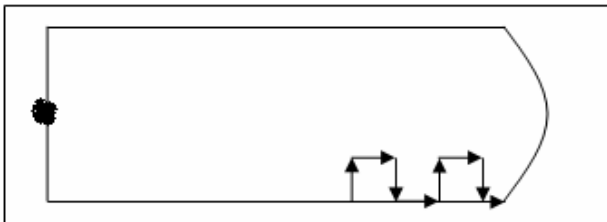

Fig 7.2: The exaggerated battlement method of differential counting

III. The Lateral Strip ('Crenellation') Technique

The field of view is moved from side to side across the width of the slide in the counting area just behind the feather edge where the cells are separated from one another and are free from artifacts.

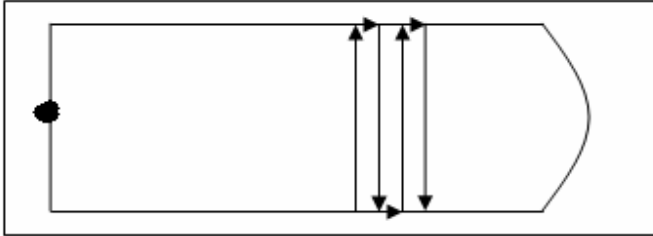

Fig 7.3 the lateral strip method of differential counting

While performing the differential count, all elements of the blood film must be observed. For example:

- Erythrocytes: size, shape, degree of hemoglobinization; presence of inclusion bodies, presence of nucleated red cells (if so, the total leucocyte count must be corrected).
- Platelets: are they present in roughly normal proportions? (10-20/HPF); do they look normal or are there many giant or bizarre forms?
- Leucocytes: the following feature should be noted: whether they are mature, immature, atypical; presence of hypersegmented neutrophils, and look for the average number of lobes, hypergranulation and vacuolation.
- Hemoparasites: malaria, borrelia, babesia, etc.

Reporting the Differential Leucocyte Count

The differential leucocyte count expressed as the percentage of each type of cell is the conventional method of reporting the differential count. It should be related to the total leucocyte count and the results reported in absolute numbers. The fact that a patient may have 60% polymorphs is of little use itself; he may have 60% of a total leucocyte count of $8.0 \times 10^9/l$, i.e., $4.8 \times 10^9/l$ neutrophils, which is quite normal but if he has 60% neutrophils in a total leucocyte count of $3.0 \times 10^9/l$, i.e., $1.8 \times 10^9/l$ neutrophils, then he has granulocytopenia.

Nucleated red cells may either be included or excluded in the differential count. If they are excluded, their number is expressed as NRBC/100 leucocytes and the total leucocyte count corrected to a true TLC so that absolute leucocyte counts are correct. If they are included, they are expressed as a percentage of the total nucleated cell count. Myelocytes and metamyelocytes, if present, are recorded separately from neutrophils. Band (stab) cells are generally counted as neutrophils but it may be useful to record them separately. An increase may point to an inflammatory process even in the absence of an absolute

leucocytosis.

The Cook-Arneth Count

Arneth attempted to classify the polymorphonuclear neutrophils into groups according to the number of lobes in the nucleus and also according to the shape of the nucleus. The procedure was too cumbersome for routine use and was modified by Cooke, who classified the neutrophils into five classes according to the number of lobes in the nucleus. The lobes can not be said to be separated if the strand of chromatin joining them is too thick. The strand must be a very fine one. Some workers suggest that the strand must be less than one-quarter of the width of the widest part of the lobe. The count is performed by examining 100 neutrophils and placing them in their correct class:

- Class I: No lobes (An early cell in which the nucleus has not started to lobulate).
- Class II: Two lobes
- Class III: Three lobes
- Class IV: Four lobes
- Class V: Five or more lobes

Interpretation of result for Cook-Arneth count

The normal proportions are:

Hematology

- Class I: 10%
- Class II: 25%
- Class III: 47%
- Class IV: 16%
- Class V: 2%

When the sum of class I and class II exceeds 45% a “shift to the left” in the Cook-Arneth count can be said to exist. That means if the figures were to be plotted on graph paper, the peak of the graph would move to the left hand side of the normal curve. It occurs in infections since new cells are released into the circulation from the marrow. When the sum of class IV and V exceeds 30% a “shift to the right” is said to occur. It occurs in vitamin B₁₂ and/or folate deficiency.

Interpretation of results for DLC

Reference value, (for adult)

	Mean Range (x10 ³ /μl)	Percentage
TLC	7.0 - 8.0	
Neutrophils	4.0 - 4.5	50 - 70
Lymphocytes	2.0	25 - 40
Monocytes	0.4	3 - 8
Eosinophils	0.2	1 - 4
Basophiles	0.025	0 - 1

I. Neutrophils

- **Neutrophilia / Neutrophilic leucocytosis**

This is an increase in the number of circulating neutrophils above normal and the conditions associated with this include: overwhelming infections, metabolic disorders (uremia, diabetic acidosis), drugs and chemicals (lead, mercury, potassium chlorate), physical and emotional stress, hematological disorders (e.g. myelogenous leukemia), tissue destruction or necrosis (burns, surgical operations).

- **Neutropenia**

This is a reduction of the absolute neutrophil count below $2.0 \times 10^9/l$ and the conditions associated with this include: myeloid hypoplasia, drugs (chloramphenicol, phenylbutazone), ionizing radiation

- **Hypergranular neutrophils (neutrophils with toxic granules)**

These are neutrophils with coarse blue black or purple granules. Such granules are indicative of severe infection or other toxic conditions.

- **Vacuolation**

Multiple clear vacuoles in the cytoplasm of

neutrophils may be seen in progressive muscular dystrophy.

- **Hypersegmentation**

Neutrophils with more than six lobes to their nucleus (as many as ten or twelve may be seen) is an important diagnostic observation indicative of megaloblastic erythropoiesis (vitamin B₁₂ and/or folic acid deficiency), iron deficiency anemia and uremia.

- **Agranular Neutrophils**

Neutrophils devoid of granules and having a pale blue cytoplasm are features of leukemia.

II. Eosinophils

- **Eosinophilia**

This is an increase eosinophil count above $0.5 \times 10^9/l$ and conditions associated with this include: allergic diseases (bronchial asthma, seasonal rhinitis), parasitic infections (trichinosis, taeniasis), skin disorders, chronic myelogenous leukemia

- **Eosinopenia**

This is a decrease in eosinophil count below $0.04 \times 10^9/l$ and conditions associated with this include: acute stress due to secretion of adrenal glucocorticoid and epinephrine, acute inflammatory

states.

III. Basophils

- **Basophilia**

This is an increase in basophil count above $0.2 \times 10^9/l$ and conditions associated with this include: allergic reactions, chronic myelogenous leukemia, and polycythemia vera.

IV. Monocytes

- **Monocytosis**

This is an increase in monocyte count above $1.0 \times 10^9/l$ and conditions associated with this include: recovery from acute infections, tuberculosis, monocytic leukemia.

- **Monocytopenia**

This is a decrease in monocyte count below $0.2 \times 10^9/l$ and conditions associated with this include: treatment with prednisone, hairy cell leukemia.

V. Lymphocytes

- **Lymphocytosis**

This is an increase in absolute lymphocyte count above $4.0 \times 10^9/l$ in adults and above $8.0 \times 10^9/l$ in children and conditions associated with this includes:

Hematology

Infectious lymphocytosis associated with coxackie virus, other viral infections (Epstein-Barr virus, cytomegalovirus), acute and chronic lymphocytic leukemia, toxoplasmosis.

- **Lymphocytopenia**

This is a decrease in lymphocyte count below $1.0 \times 10^9/l$ in adults and below $3.0 \times 10^9/l$ in children and conditions associated with this includes: immune deficiency disorders (HIV/AIDS), drugs and radiation therapy

- **Atypical lymphocytes**

These are lymphocytes with excessive vacuolated cytoplasm, monocytoid nucleus and sometimes nucleoli. They are primarily seen in infectious mononucleosis which is an acute, self-limiting infectious disease of the reticuloendothelial tissues, especially the lymphatic tissues.

Review Questions

1. Define differential leucocyte count.
2. What is the importance reporting the differential leucocyte counts in absolute terms?
3. What other elements of the blood film should be evaluated while doing the differential leucocyte count?
4. Explain the Cook-Arneth count.

CHAPTER EIGHT

RETICULOCYTE COUNT

Learning objectives

At the end of this chapter, the student shall be able to:

- Define reticulocytes
- Explain the relationship between the number of reticulocytes in the peripheral blood and erythropoietic activity in the bone marrow
- Discuss the reticulocyte production index
- Prepare supravital dyes in the right proportion
- Perform reticulocyte count on a sample of blood
- Indicate the normal reticulocyte count
- Discuss the clinical implications of the reticulocyte count

Reticulocytes are juvenile red cells; they contain remnants of the ribosomal RNA which was present in large amounts in the cytoplasm of the nucleated precursors from which they were derived. The most immature reticulocytes are those with the largest amount of precipitable material and in the least immature only a few dots or strands are seen. The number of

reticulocytes in the peripheral blood is a fairly accurate reflection of erythropoietic activity assuming that the reticulocytes are released normally from the bone marrow and that they remain in the circulation for the normal period of time. Complete loss of basophilic material probably occurs as a rule in the blood stream after the cells have left the bone marrow.

The ripening process is thought to take 2-3 days of which about 24 hours are spent in the circulation. When there is an increased erythropoietic stimulus as in hemolytic anemia there will be premature release of reticulocytes into the circulation as their transit time in the bone marrow is reduced, the so-called 'stress' or 'shift' reticulocytosis.

Principle of reticulocyte count

The count is based on the property of ribosomal RNA to react with basic dyes such as new methylene blue or brilliant cresyl blue to form a blue precipitate of granules or filaments. Although reticulocytes are larger than mature red cells and show diffuse basophilic staining (polychromasia) in Romanowsky stained films, only supravital staining techniques enable their number to be determined with sufficient accuracy.

Staining Solution

New methylene blue (1%) or Brilliant cresyl blue (1%). Better and more reliable results are obtained with new methylene blue than brilliant cresyl blue as the former stains the reticulo-filamentous material in the reticulocytes more deeply and more uniformly than does the latter.

Method

1. Deliver 2-3 drops of the dye solution into 75 X 10mm glass or plastic tube using a Pasteur pipette.
2. Add 2-4 drops the patient's EDTA anticoagulated blood to the dye solution and mix. Stopper the tube and incubate at 37°C for 10-15 minutes. The exact volume of blood to be added to the dye solution for optimal staining depends upon the red cell count. A larger proportion of anemic blood and a smaller proportion polycythemic blood should be added than normal blood.
3. After incubation, resuspend the cells by gentle mixing and make films on glass slides in the usual way. When dry, examine the films without fixing or counter staining. In a successful preparation, the reticulofilamentous material should be stained deep

Hematology

blue and the non-reticulated cells stained diffuse shades of pale greenish blue.

Counting

An area of the film should be chosen for the count where the cells are undistorted and where the staining is good. To count the cells, the oil immersion objective and if possible eye pieces provided with an adjustable diaphragm are used. If such eyepieces are not available, a paper or cardboard diaphragm in the center of which has been cut a small square with sides about 4mm in length can be inserted into an eyepiece and used as a substitute.

The counting procedure should be appropriate to the number of reticulocytes as estimated on the stained blood film. Very large numbers of cells have to be surveyed if a reasonably accurate count is to be obtained when the reticulocyte number is small. When the reticulocyte count is expected to be 10% a total of 500 red cells should be counted noting the number of reticulocytes. If less than 10% reticulocytes are expected, at least 1000 red cells should be counted.

$$\text{Reticulocyte count (\%)} = \frac{\text{Reticulocyte number} \times 100}{\text{Total red cells}}$$

Hematology

RBC number

Absolute reticulocyte count = Reticulocyte count (%) X RBC count

An alternative method is based on the principle of 'balanced sampling' using a Miller ocular. This is an eyepiece giving a square field in the corner of which is a second ruled square one-ninth of the area of the total square. Reticulocytes are counted in the large square and red cells in the small square in successive fields until at least 300 red cells are counted.

$$\text{Reticulocyte count (\%)} = \frac{\text{Reticulocyte number} \times 100}{\text{RBC number} \times 9}$$

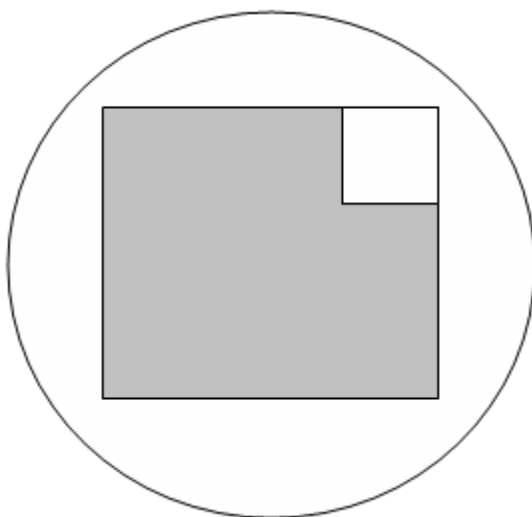

Fig 8.1: Miller ocular eyepiece used for counting reticulocytes; it consists of two squares whose areas have a ratio 1:9

The Reticulocyte Production Index (RPI)

In the presence of anemia the reticulocyte percentage does not accurately reflect reticulocyte production, since each reticulocyte released is being diluted into fewer adult red cells. A better measure of erythroid production is the reticulocyte production index (RPI). The reticulocyte percentage is first corrected to a normal hematocrit of 0.45 (H). For example, a reticulocyte

Hematology

percentage of 10% in a patient with a hematocrit of 0.23 (l/l) would be equivalent to a percentage of 5% in a patient with a hematocrit of 0.45% (l/l). This is equivalent to calculating the absolute reticulocyte count in terms of red cell number. Another correction is made because erythropoietin production in response to anemia leads to premature release of newly formed reticulocytes and these stress reticulocytes take up to two days rather than one to mature into adult erythrocytes. If many polychromatophils are seen on the stained blood film, then a correction factor of 2 is divided into the corrected reticulocyte percentage, for example

$$\text{RPI} = \frac{10 \times 23/45 \text{ (hematocrit correction)}}{2.0 \text{ (maturation time correction)}} = 2.5$$

Maturation factors from 1.0-2.0 are used, the higher numbers if there is a great deal of polychromatophilia in the peripheral blood film, and the lower numbers if there is little. The RPI is an approximate measure of effective red cell production in the marrow. A normal marrow has an index of 1.0. In hemolytic anemia with excessive destruction of red cells in the peripheral blood in a functionally normal marrow, this index may be 3-7 times higher than normal.

When there is marrow damage, erythropoietin suppression or a deficiency of iron, vitamin B₁₂ or folic acid, the index is less than expected for the degree of anemia, i.e., 2 or less. Ineffective erythropoiesis, with intramedullary (marrow) destruction of erythroid precursors can be deduced if the marrow contains many normoblasts but the RPI is low.

Sources of error in the reticulocyte count

- Insufficient number of cells counted.
- Confusion of reticulocytes with red cell inclusions like Pappenheimer bodies and Heinz bodies.

Interpretation of results

Reference value

0.5 - 2.5% of total erythrocytes (or 25 - 85 X 10⁹/l)

Increased numbers: Reticulocytosis

This means that hyperactive erythropoiesis is occurring as the bone marrow replaces cells lost or prematurely destroyed. Identifying reticulocytosis may lead to the recognition of an otherwise occult disease such as hidden chronic hemorrhage or unrecognized hemolysis. An increase in the reticulocyte number is seen in the following conditions:

Hematology

- Hemolytic anemias (Immune HA, Primary RBC membrane defects, sickle cell disease, RBC enzyme deficits, exposure to toxins).
- Following hemorrhage
- Following treatment of anemias where an increase in the reticulocyte number may be used as an index of the effectiveness of treatment. For example, after doses of iron in iron deficiency anemia where the reticulocyte count may exceed 20%; Proportional increase when pernicious anemia is treated by transfusion or vitamin B₁₂ therapy.
- Physiologic increase in pregnancy and in infants.

Decreased levels

This means that the bone marrow is not producing enough erythrocytes.

A decrease in the reticulocyte number is seen in iron deficiency anemia, aplastic anemia, radiation therapy, untreated pernicious anemia, tumor in marrow.

Review Questions

1. What are reticulocytes?
2. How could the number of reticulocytes in the peripheral blood be a fairly accurate reflection of erythropoietic activity in the bone marrow?
3. Define supravital staining.
4. How do you manage to count the number of reticulocytes in each field of the microscope after you stain the cells with supravital dyes?
5. How do you calculate the relative number of reticulocytes in the patient sample?
6. Briefly discuss RPI.
7. What is the clinical interpretation of an increase in the number of reticulocytes in the peripheral blood in general terms?

CHAPTER NINE

HEMOGLOBIN

Learning objectives

At the end of this chapter, the student shall be able to:

- Describe the structure of hemoglobin
- Discuss the synthesis of heme and globin moieties of hemoglobin
- Explain the functions of hemoglobin
- State the principles of hemoglobin estimation in clinical practice
- Explain the principle and advantages of the cyanmethemoglobin method of hemoglobin determination
- Mention the normal hemoglobin values in the different age groups

9.1. Structure of hemoglobin

Hemoglobin (Hb), the main component of the red blood cell, is a conjugated protein that serves as the vehicle for the transportation of oxygen and carbon dioxide. When fully saturated, each gram of hemoglobin holds 1.34ml of oxygen. The red cell mass of the adult contains approximately 600g of hemoglobin, capable of carrying 800ml of oxygen.

A molecule of hemoglobin consists of two pairs of polypeptide chains (globin) and four prosthetic heme groups, each containing one atom of ferrous iron. Each heme group is precisely located in a pocket or fold of one of polypeptide chains. Located near the surface of the molecule, the heme reversible combines with one molecule of oxygen or carbon dioxide. At least three distinct hemoglobin types are found postnatally in normal individuals, and the structure of each has been determined. These are HbA, HbF and HbA₂.

- Hb A is the major (96-98%) normal adult hemoglobin. The polypeptide chains of the globin part of the molecules are of two types: two identical α -chains, each with 141 amino acids; and two

Hematology

identical β -chains, with 146 amino acids each.

- Hb F is the major hemoglobin of the fetus and the new born infant. The two α -chains are identical to those of Hb A; and two γ -chains, with 146 amino acids residues, differ from β -chains. Only traces of Hb F (<1.0%) are found in adults.
- Hb A₂ account for 1.5% to 3.5% of normal adult hemoglobin. Its two α -chains are the same as in Hb A and Hb F; its two δ -chains differ from β -chains in only 8 of their 146 amino acids.

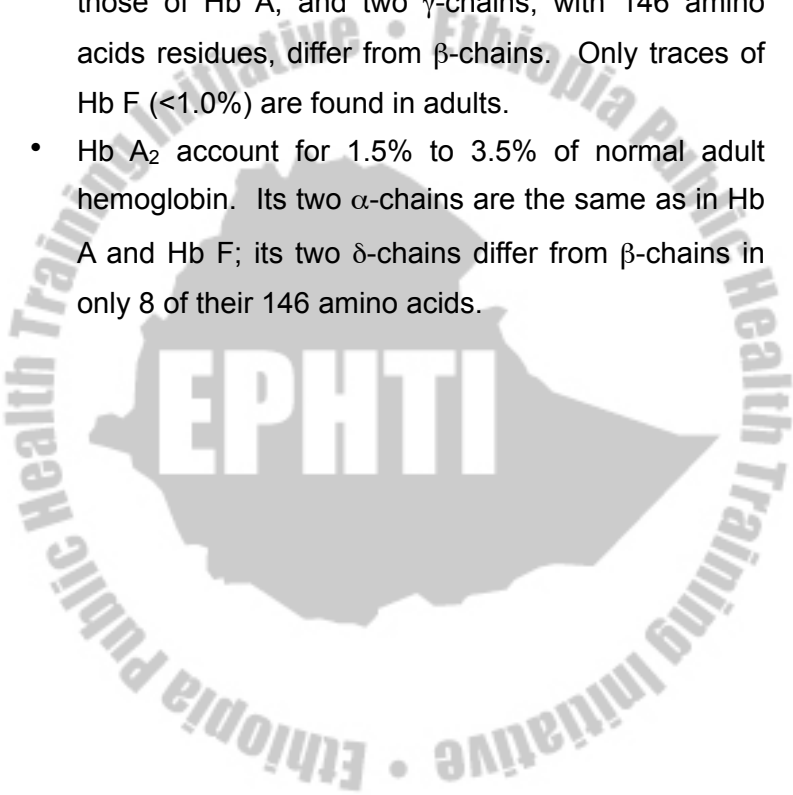

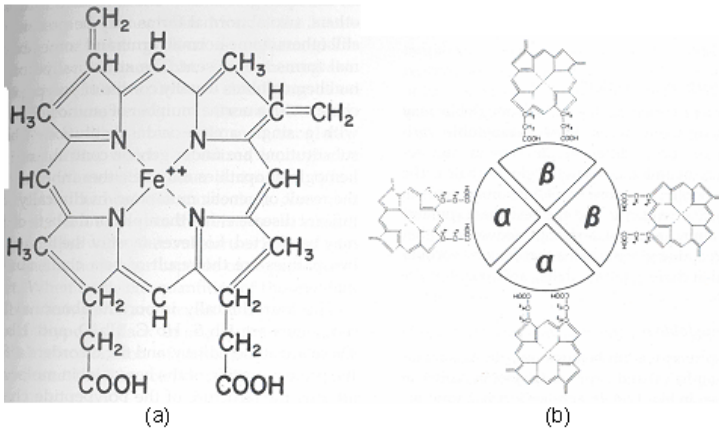

Fig. 9.1 Hemoglobin molecules (a) Heme moiety (one protoporphyrin ring with a single iron atom); (b) Hemoglobin A molecule (made up of four heme groups with their appropriate globin chains—two alpha and two beta).

Embryonic hemoglobins: the zeta (ζ) chain is the embryonic analogue of the α -chain and may combine with epsilon (ϵ) chains to form Hb Gower-1 ($\zeta_2\epsilon_2$) or with γ -chains to form Hb Portland-1 ($\zeta_2\gamma_2$). The ϵ -chain is the embryonic counterpart of the γ -, β -, and δ -chains and combines with α -chains to form Hb Gower-2 ($\alpha_2\epsilon_2$). Hb Gower-1, Hb Portland-1, and Hb Gower-2 are the embryonic hemoglobins and are found in normal human embryos and fetuses with gestational age of less than

three months.

9.2 Hemoglobin synthesis

Heme synthesis

Heme synthesis occurs in most cells of the body, except the mature erythrocytes, but most abundantly in the erythyroid precursors. Succinylcoenzyme A (from the tricarboxylic acid cycle) condenses with glycine to form the unstable intermediate α -amino β -ketoacid, which is readily decarboxylated to δ -aminolevulinic acid (ALA). This condensation requires pyridoxal phosphate (vitamin B₆) and occurs in mitochondria. Two molecules of ALA condense to form the monopyrrole, porphobilinogen, catalyzed by the enzyme ALA-dehydrase. Four molecules of porphobilinogen react to form uroporphyrinogen III or I. The type III isomer is converted, by way of coproporphyrinogen III and protoporphyrinogen, to protoporphyrin. Iron is inserted into protoporphyrin by the mitochondrial enzyme ferrochelatase to form the finished heme moiety.

Globin synthesis

Globin synthesis occurs in the cytoplasm of the

normoblast and reticulocyte. The polypeptide chains are manufactured on the ribosomes. Specific small soluble RNA molecules determine the placement of each amino acid according to the code in the messenger RNA (mRNA). Progressive growth of the polypeptide chain begins at the amino end. This process of protein synthesis occurs on ribosomes clustered into polyribosomes, which are held together by the mRNA. The polypeptide chains released from the ribosomes are folded into their three-dimensional configurations spontaneously.

The complete globin structure consists of four polypeptide chains formed by two dissimilar pairs. Control of hemoglobin synthesis is exerted primarily through the action of heme. Increased heme inhibits further heme synthesis by inhibiting the activity and synthesis of ALA synthase. Heme also promoted globin synthesis, mainly at the site of chain initiation, the interaction of ribosomes with mRNA.

9.3 Function of hemoglobin

The functions of hemoglobin include:

- Transport of O₂ from the lungs to the tissues and of

CO₂ in the reverse direction.

- Assisting in acid-base regulation by eliminating CO₂ in the lungs and by the buffering action of hemoglobin.

9.4. Determination of hemoglobin concentration

Hemoglobin is measured to detect anemia and its severity and to monitor an anemic patient's response to treatment. The test is also performed to check the hemoglobin level of a blood donor prior to donating blood. Capillary blood or EDTA anticoagulated venous blood can be used.

The hemoglobin content a solution may be estimated by several methods: by measurement of its color, its power of combining with oxygen or carbonmonoxide and by its iron content. Hemoglobin is measured photometrically or estimated using a visual comparative technique. In photometric techniques the absorbance of hemoglobin in a blood sample is measured electronically using a filter colorimeter or a direct read-out hemoglobin meter. When it is not possible to measure hemoglobin

accurately using a photometric technique a visual comparative technique can help to detect anemia and assess its severity.

Hemoglobin values are expressed in grams per liter (g/l) or grams per deciliter (g/dl). Grams/liter is the recommended way of expressing the mass concentration of hemoglobin.

I. CYANMETHEMOGLOBIN (HEMIGLOBINCYANIDE-HICN) METHOD

This technique is ICSH recommended because stable hemiglobincyanide (HiCN) standards are available to calibrate instruments. The technique is also used as a reference method against which all other color comparison methods should be calibrated.

Principle of the test

Whole blood is diluted 1 in 201 in a modified Drabkin's solution which contains potassium ferricyanide and potassium cyanide. The red cells are hemolyzed and the hemoglobin is oxidized by the ferricyanide to methemoglobin (Hemoglobin, Hi). This is converted by

the cyanide to stable hemoglobin cyanide (HiCN). Absorbance of the HiCN solution is read in a spectrophotometer at wavelength 540nm or in a filter colorimeter using a yellow-green filter. The absorbance obtained is compared with that of a reference HiCN standard solution. Hemoglobin values are obtained from tables prepared from a calibration graph or if using a direct read-out hemoglobin meter, for the digital display.

Advantages

- Convenient method
- Readily available and stable standard solution (readings need not be made immediately after dilution)
- All forms of hemoglobin except sulfhemoglobin (SHb) are readily converted to HiCN.

Diluting fluid and standards

A. Drabkin's neutral diluting fluid:

Potassium ferricyanide	200 mg
Potassium cyanide	50 mg
Potassium dihydrogen phosphate	140 mg
Non-ionic detergent	1 ml
(e.g. Sterox S.E. or Triton X-100	
Distilled or deionized water	to 1 liter

Note

- The solution should be clear and pale yellow, have a pH of 7.0 to 7.4, and give a reading of zero when measured in the photometer at 540nm against a water blank and must not be used if it loses its color or becomes turbid.
- Substituting Potassium dihydrogen phosphate in this reagent for sodium bicarbonate in the original Drabkin reagent shortens the time needed for complete conversion of Hb to HiCN from 10 minutes to 3 minutes.
- The detergent enhances lysis of erythrocytes and decreases turbidity from protein concentration.
- Care must be taken with potassium cyanide in the preparation of the Drabkin solution, as salts or solutions of cyanide are poisonous.
- Drabkin's fluid must be stored in a light opaque container, e.g. brown glass bottle or ordinary glass bottle wrapped in silver foil at room temperature, but should be prepared fresh once a month.

B. Hemiglobincyanide (cyanmethemoglobin) standard

This is needed to calibrate a filter colorimeter. HiCN solutions are stable for long periods (2 years or longer).

Hemiglobincyanide (HiCN) reference standard solutions are available as 'Ready to use diluted HiCN standards equivalent to hemoglobin values 30g/l, 115g/l and 180g/l.'

Preparing a calibration graph

1. Allow the standards to warm to room temperature.
2. Place a yellow-green filter in the colorimeter or set the wavelength to read 540nm.
3. Zero the colorimeter with Drabkin's neutral diluting fluid.
4. Read the absorbance of each standard beginning with the lowest.
5. Take a sheet of graph paper and plot the absorbance of each standard (vertical axis) against its concentration in g/l (horizontal axis).
6. Draw a straight line from zero through the points plotted. Extend the line to obtain readings up to 200g/l.
7. From the graph, make a table for hemoglobin values from 20-200g/l.

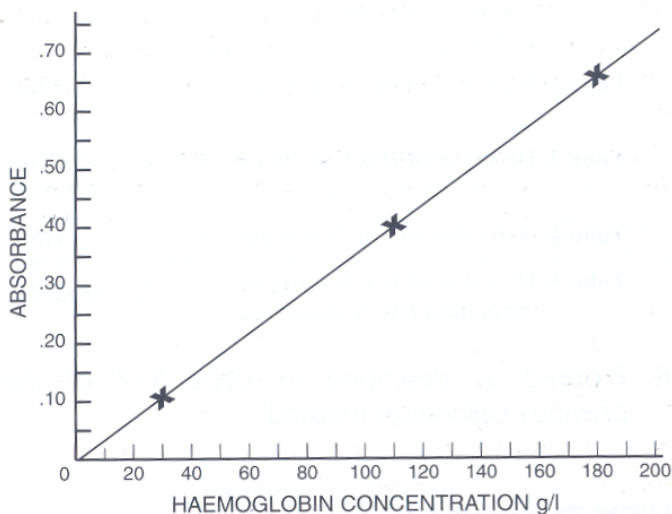

Fig. 9.2: HiCN hemoglobin calibration graph using commercially produced HiCN standards: 30g/l, 115g/l, 180g/l.

Test method

1. Measure carefully 20 μ l (0.02ml, 20cmm) of capillary blood or well-mixed venous blood and dispense it into 3.98ml Drabkin's neutral diluting fluid.
2. Stopper the tube, mix, and leave the diluted blood at room temperature, protected from sunlight, for 4-5 minutes. This time is adequate for conversion of hemoglobin to HiCN when using a neutral (pH 7.0-7.4) Drabkin's reagent. Up to 20 minutes is required when using an alkaline Drabkin's reagent.

3. Place a yellow-green filter in the colorimeter or set the wavelength at 540nm
4. Zero the colorimeter with Drabkin's fluid and read the absorbance of the patient's sample.
5. Using the table prepared from the calibration graph, read off the patient's hemoglobin value.

Sources of error when measuring hemoglobin photometrically

The following are the most important and commonest errors that can lead to unreliable test results when measuring hemoglobin photometrically:

- Not measuring the correct volume of blood due to poor technique or using a wet or chipped pipette.
- When using anticoagulated venous blood, not mixing the sample sufficiently.
- Not ensuring that the optical surfaces of a cuvette are clean and dry and there are no air bubbles in the solution.

Technique to prevent cuvette-related errors

1. Hold a clean cuvette only by its frosted (matt) or

ridged sides. When transferring a solution to a cuvette, allow the fluid to run down the inside wall of the cuvette. This will help to avoid air bubbles in the solution. Do not fill a cuvette more than three quarters full.

2. Using a tissue or soft clean cloth, wipe clean the clear optical surfaces of the cuvette. Carefully insert the cuvette in the colorimeter or hemoglobin meter (optical surfaces facing the light source).

Ensure a solution is at room temperature before reading its absorbance otherwise condensation will form on the outside of the cuvette which will give an incorrect reading.

- Not protecting a colorimeter or hemoglobin meter from direct sunlight and not checking the performance of an instrument or maintaining it as instructed by the manufacturer. A common error when using a filter colorimeter is using a glass filter which is not clean.
- Not checking a diluting fluid such as Drabkin's for signs of deterioration.
- Abnormal plasma proteins and grossly increased leucocyte numbers may result in turbidity and hence erroneously high Hb values. Turbidity can

be avoided by centrifuging the diluted sample or adding 5g/l NaCl to the reagent.

II. HemoCue non-dilution photometric technique

This method of measuring hemoglobin is both precise and accurate. It is one of the few photometric hemoglobin systems that does not require dilution or measuring of the blood

A small drop (10 μ l) of blood is drawn by capillary attraction into a specially designed single used micro-cuvette of only 0.13mm light-path which contains dry reagents (sodium desoxycholate, sodium azide, and sodium nitrite). These lyze the blood and convert it to azidmethemoglobin, the absorption of which is read electronically in the HemoCue meter at wavelengths 565nm and 880nm (later reading compensates for any turbidity in the sample).

The cuvettes cannot be reused. They have a shelf-life of about 2 years and must be kept moisture-free. The HemoCue meter weighs about 700g and is battery-powered or it can be operated from a mains electricity supply using an AC-adaptor. A direct read-out of

hemoglobin (g/l or mmol/l) is obtained within 1 minute of inserting the cuvette in the meter. A control cuvette is supplied to check the performance of the meter.

Principle

The reaction in the cuvette is a modified azidemethemoglobin reaction. The erythrocyte membranes are disintegrated by sodium desoxycholate, releasing the hemoglobin. Sodium nitrite converts hemoglobin iron from the ferrous to the ferric state to form methemoglobin which then combines with azide to form azidemethemoglobin.

Test method

1. Make sure the HemoCue photometer is switched on and that the cuvette holder is in its outer position. When flashing dashes and "READY" are seen on the display the photometer is ready for use. The photometer will show the letters "Hb" for six seconds in its display when switched on.
2. Take out as many microcuvettes from the package as needed for the test. Hold the microcuvette by two fingers in its rear end and bring the filling tip in contact with a freely-flowing blood that comes from a skin puncture. Avoid contamination of the optical

eye. Reseal the package immediately. Allow the cavity of the microcuvette to fill completely by capillary action. Do not overfill the cavity of the microcuvette. If air bubbles are seen in the optical eye of the cuvette due to inadequate filling of blood, the cuvette should be discarded and another cuvette be filled properly with the blood sample.

3. When completely filled, wipe off the outside of the microcuvette with a clean and lint-free tissue.
4. Place the filled HemoCue microcuvette in the cuvette holder of the photometer.
5. Push the cuvette holder to its inner position. When the cuvette holder reaches inner position fixed dashes and "MEASURING" will appear in the display.
6. After 30-50 seconds the photometer will find the steady state of the chemical reaction and the result will appear in the display. The display will show this result for 5 minutes provided the cuvette holder is left in its inner position.
7. After 5 minutes the display will show the letters "Hb". A remeasurement may be initiated by moving the cuvette holder to its outer position. Wait for the flashing dashes and "READY" to appear in the display and push the cuvette holder back to its inner

position.

8. Pull the cuvette holder to its outer position and wait for the flashing dashes and "READY" to appear in the display. The photometer is now ready for a new measurement. If the photometer is not to be used for several hours, switch it off.

Note

- The HemoCue Microcuvettes should be stored at a temperature of 18°-30°C. Do not refrigerate. Use the HemoCue Microcuvettes prior to expiration date.
- The reagents within the HemoCue Microcuvette are moisture-sensitive. Replace cap immediately after microcuvettes are removed from the package.
- As this test method relies on photometric measurement, care should be taken not to hold the microcuvette by the filling tip. The outer surface of the cuvette's circular optical eye should be wiped away with a lint-free tissue prior to reading.
- The filled cuvette should be measured within 10 minutes after it has been filled and it should be held horizontally. The optical eye of the cuvette should also be inspected for air bubbles, which if

present, can produce erroneously low reading. Small air bubbles around the edge do not influence the result.

- Carboxyhemoglobin, leucocytosis and turbidity do not interfere with readings as the HemoCue photometer employs a double wavelength measuring method.
- If quality control check is required, it may be performed by utilizing a commercially available Hematology Control. Cyanmethemoglobin standards should not be used with this test. Calibration may be checked daily by using the control cuvette supplied with the photometer.
- The measured hemoglobin values are read directly from the HemoCue photometer in g/dl. No calculations are necessary. The test is linear up to 25.6g/dl.

III. Oxyhemoglobin Method

This is a reliable and inexpensive method of measuring hemoglobin but there is no stable oxyhemoglobin (HbO₂) reference standard solution available for the direct calibration of the HbO₂ technique. Preparation of a calibration graph for use with a filter colorimeter,

requires the use of a secondary blood standard, i.e. a whole blood or hemolysate of known hemoglobin value (between 140-160g/l) that has been previously analyzed by the HiCN method or other well calibrated technique.

Principle of test

Blood is diluted in a weak ammonia solution. This lyses the red cells. The absorbance of the solution is measured as oxyhemoglobin in a filter colorimeter using a yellow-green filter or at wavelength 540nm. Hemoglobin values are obtained from tables prepared from a calibration graph. Methemoglobin and carboxyhemoglobin are not accurately detected but these are normally present only in trace amounts and are not oxygen-carrying forms of hemoglobin.

Diluting fluid

Weak 0.4 ml/l (0.04%) ammonia water, the reagent is stable when stored in a tightly stoppered bottle. Renew every 6 weeks.

Preparation of calibration graph for HbO₂ technique

A series of dilutions are prepared from a whole blood or standard hemolysate of known hemoglobin value,

Hematology

preferable between 140-160g/l.

1. Prepare a 1 in 201 dilution of the standard blood or hemolysate in the ammonia water diluting fluid as follows:

- Dispense 20ml of diluting fluid into a screw cap container.
- Add exactly 0.1 ml of the standard blood or hemolysate. Cap and mix well.

2. Take 6 tubes and label, B (blank), 1,2,3,4,5. Pipette into each tube as follows:

Tube	B	1	2	3	4	5
ml HiCN sd	-	4	3	2	1	5
ml Drabkin's fluid	5	1	2	3	4	-

Stopper each tube and mix well.

3. Place a yellow-green filter in the colorimeter or set the wavelength at 540nm.
4. Zero the colorimeter using the ammonia water in tube B. Read the absorbance of each tube.
5. Calculate the hemoglobin equivalent in g/l of solutions in tubes 1 to 5.

Tube 1: Hb value of standard $\times 4/5 =$ Hb g/l

Hematology

Tube 2: Hb value of standard $\times 3/5 =$ Hb g/l

Tube 3: Hb value of standard $\times 2/5 =$ Hb g/l

Tube 4: Hb value of standard $\times 1/5 =$ Hb g/l

Tube 5: Hb value of standard = Hb g/l (no calculation required)

- 6 Take a sheet of graph paper and plot the absorbance of each standard (vertical axis) against its concentration in g/l (horizontal axis).
- 7 Draw a straight line from zero through the points plotted. Extend the line to obtain readings up to 200g/l. From the graph make a table of Hb values from 20-200g/l.

Test method

1. Measure carefully 20 μ l of capillary or well-mixed venous blood and dispense into 3.98ml (4ml) ammonia water diluting fluid
2. Stopper the tube and mix well.
3. Place a yellow-green filter in the colorimeter or set the wavelength at 540nm.
4. Zero the colorimeter with the ammonia water diluting fluid. Read the absorbance of the patient's sample.
5. Using the table prepared from the calibration graph, read off the patient's hemoglobin value.

Disadvantage

- Lack of a stable HbO₂ standard.
- Does not measure HbCO, Hi or SHb.

IV. Alkaline Hematin Method

A useful ancillary method under special circumstances as it gives a true estimate of total Hb even if HbCO, Hi or SHb is present.

Disadvantage

- Certain forms of Hb are resistant to alkali denaturation, in particular Hb-F and Hb Bart.
- More cumbersome and less accurate than the HICN or HbO₂ methods and thus is unsuitable for use as a routine method.

Test method

50μl of blood is added to 4.95 ml of 0.1N NaOH and heated in a boiling water bath for exactly 4min. The

sample is then cooled rapidly in cold water and when cool matched against the standard in a colorimeter at 540nm.

Standard

A mixture of chromium potassium sulphate, cobaltous sulphate and potassium dichromate in aqueous solution. The solution is equal in color to a 1:100 dilution of blood containing 16g/dl Hb.

V. Acid Hematin Method (Sahli-Hellige)

This visual comparative method of estimating hemoglobin although still used in some health centers and hospitals is not recommended because of its unacceptable imprecision and inaccuracy. Most of the problems associated with the Sahli method are due to the instability of acid hematin, fading of the color glass standard and difficulty in matching it to the acid hematin solution. Conversion to acid hematin is slow. HbF is not converted to acid hematin and therefore the Sahli method is not suitable for measuring hemoglobin levels in infants up to 3 months.

Principle

Hematology

Hemoglobin in a sample of blood is converted to a brown colored acid hematin by treatment with 0.1 N HCl and after allowing the diluted sample to stand for 5 minute to ensure complete conversion to acid hematin it is diluted with distilled water until its color match as with the color of an artificial standard (tinted glass).

Materials

Sahli hemoglobinometer

Sahli pipette

Stirring glass rod

Dropping pipette

Absorbent cotton

0.1N HCl

Test method

1. Fill the graduated tube to the "20" mark of the red graduation or to the 3g/dl mark of the yellow graduation with 0.1N HCl.
2. Draw venous or capillary blood to the 0.02ml mark of the Sahli pipette. Do not allow air bubbles to enter. Do not take the first drop of blood from the finger.
3. Wipe the outside of the pipette with absorbent paper. Check that the blood is still on the mark.

4. Blow the blood from the pipette into the graduated pipette into the graduated tube of the acid solution. Rinse the pipette by drawing and blowing out the acid solution 3 times. The mixture of the blood and acid gives a brownish color. Allow to stand for 5 minutes.
5. Place the graduated tube in the hemoglobinometer stand facing a window. Compare the color of the tube containing diluted blood with the color of the reference tube. If the color of the diluted sample is darker than that of the reference, continue to dilute by adding 0.1N HCl or distilled water drop by drop. Stir with the glass rod after adding each drop. Remove the rod and compare the colors of the two tubes. Stop when the colors match.
6. Note the mark reached. Depending on the type of hemoglobinometer, this gives the hemoglobin concentration either in g/dl or as a percentage of "normal". To convert percentages to g/dl, multiply the reading by 0.146.

VI. Hemoglobin color scale

Many color comparison methods have been developed in the past but these have become obsolete because

they were not sufficiently accurate or the colors were not durable. A new low-cost hemoglobin color scale has been developed for diagnosing anemia which is reliable to within 10 g/l (1 g/dl). It consists of a set of printed color shades representing hemoglobin levels between 4 and 14 g/dl. The color of a drop of blood collected onto a specific type of absorbent paper is compared to that on the chart. Validation studies in blood transfusion centers have shown the scale to be more reliable and easier to use than the copper sulphate method in donor selection checks.

VII. Copper Sulphate Densitometry

This is a qualitative method based on the capacity of a standard solution of copper sulphate to cause the suspension or sinking of a drop of a sample of blood as a measure of specific gravity of the latter and corresponding to its hemoglobin concentration. The method is routinely utilized in some blood banking laboratories in the screening of blood donors for the presence of anemia. The two strengths of copper sulphate solution of specific gravity 1.044 and 1.049 are proved to be simple and accurate in detecting hemoglobin level of 8 g/dl and 11 g/dl, respectively.

Interpretation of hemoglobin test results

Normal hemoglobin levels vary according to age and gender, and the altitude at which a person lives.

Normal hemoglobin reference range:

Children at birth	135-195 g/l
children 2 y – 5 y	110-140 g/l
Children 6 y – 12 y	115-155 g/l
Adult men	130-180 g/l
Adult women	120-150 g/l
Pregnant women	110-138 g/l

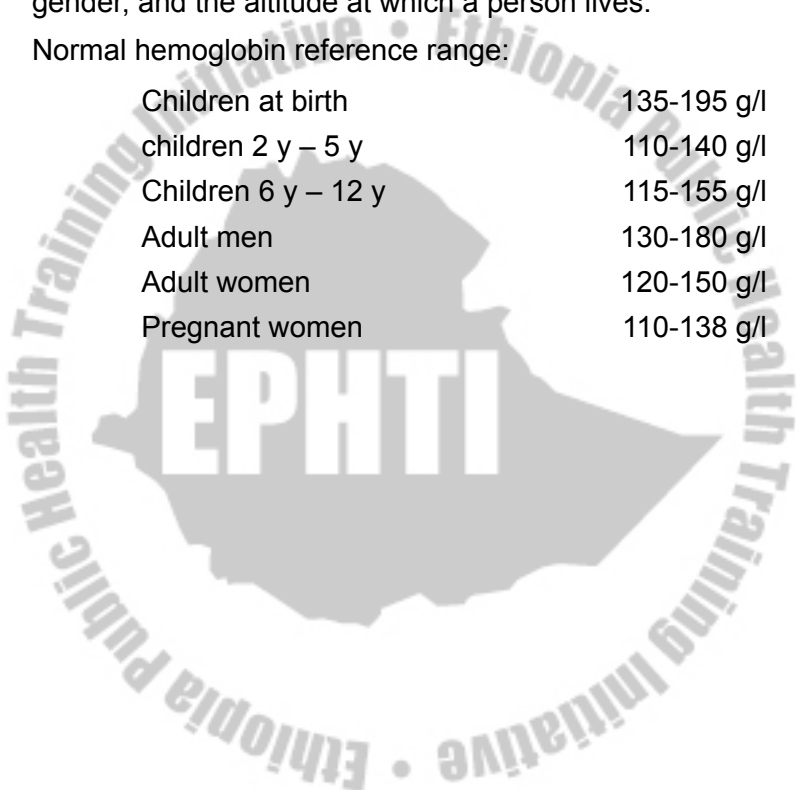

Review Questions

1. Describe synthesis of the heme and globin moieties of hemoglobin.
2. Summarize the functions of hemoglobin in the body.
3. What are the two most commonly applied color comparison methods for measurement of hemoglobin in a sample of blood? Write the test principle of each of these methods.
4. Compare and contrast (in terms of accuracy, advantage, drawbacks, etc.) the two routine methods of hemoglobin quantitation.
5. How do you check the linearity of the spectrophotometric method of hemoglobin quantitation in the laboratory?
6. What is the clinical implication of hemoglobin measurement in a sample of blood?

CHAPTER TEN

PACKED CELL VOLUME

Learning objectives

At the end of this chapter, the student shall be able to:

- Define packed cell volume
- Identify the methods used in hematocrit determination
- Perform PCV determination on a sample of blood using the microhematocrit and Wintrobe method
- List the materials required in PCV determination using the microhematocrit method
- Discuss the clinical significance of PCV determination
- Indicate the normal hematocrit values in health

The packed cell volume (PCV), also called hematocrit (Hct) is the proportion of whole blood occupied by red cells, expressed as a ratio (liter/liter) or as a percentage. It is one of the simplest, most accurate and most valuable of all hematological investigations. It is of greater reliability and usefulness than the red cell count

Hematology

that is performed manually. In conjunction with estimation of hemoglobin and RBC count, knowledge of PCV enables the calculation of the red cell indices (absolute values that indicate red cell volume, hemoglobin content and concentration) that are widely used in the classification of anemias.

The PCV is also used to screen for anemia when it is not possible to measure hemoglobin, and to diagnose polycythemia vera and to monitor its treatment. It is suitable for screening large clinic populations, e.g. antenatal clinics. To measure the PCV, either well mixed well oxygenated EDTA anticoagulated blood can be used or capillary blood collected into a heparinized capillary. There are two methods of determination: microhematocrit method and macrohematocrit (Wintrobe) method.

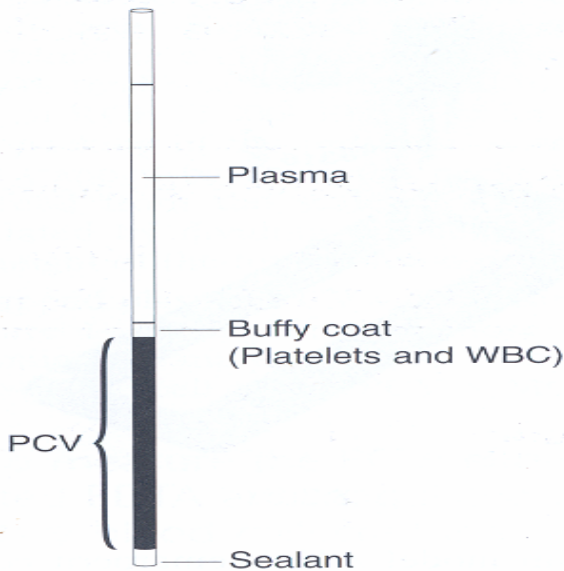

Fig. 10.1 Spun microhematocrit tube

10.1. Microhematocrit method

Materials required

- Capillary tubes
These need to be plain or heparinized capillaries, measuring 75mm in length with an internal diameter of 1mm and wall thickness of 0.2-0.5mm. Plain capillaries are often blue-tipped and heparinized capillaries, red-tipped. The plain ones are used for

Hematology

anticoagulated venous blood while the heparinized ones (inside coated with 2 I.U. heparin) are used for direct collection of capillary blood from skin puncture,

- Microhematocrit centrifuge
- Reading device

There are two types of microhematocrit PCV reader, i.e. an integral spiral reader which fits inside the centrifuge allowing PCV measurements to be made after centrifuging with the capillaries in place in the rotor, and a hand-held scale or graph. A hand-held PCV reader can be used to read samples centrifuged in any microhematocrit centrifuge, whereas an integral PCV reader can usually be used only with the centrifuge for which it has been designed. (see fig 8.1)

- Sealant

Although the end of a capillary can be heat-sealed this often distorts the end of the tube resulting in breakage, or the heat damages the red cells resulting in an incorrect PCV. Capillaries are best sealed using a plastic sealant, modeling clay, or plasticine.

- Materials for skin puncture

Hematology



Fig. 10.2 (a) Microhematocrit centrifuge (b) Spiral reader located on the rotor head, used to read PCVs after centrifuging. (c) Graph PCV reader. (d) Sealant used to seal capillaries.

Test method

- 1 Allow the blood to enter the tube by capillarity (if anticoagulated venous blood, adequate mixing is

Hematology

mandatory) leaving at least 15mm unfilled (or fill $\frac{3}{4}$ th of the capillary tube).

- 2 Seal the capillary tubes by vertically placing the dry end into a tray of sealing compound (wax or plasticin). Rotate the capillary tube slightly and remove it from the tray. The sealant plug should be 4-6mm long. Inspect the seal for a flat bottom.
- 3 Place the filled, sealed capillary tube in the grooves (slots) of the centrifuge with the sealed end toward the periphery.
- 4 Set the timer of the centrifuge at 5 minute and spin at 10,000-15,000g.
5. Read the PCV using a reading device that is either part of the centrifuge or separate from it. Alternatively, the ratio of the red cell column to whole column (i.e., plasma and red cells) can be calculated from measurements obtained by placing the tube against arithmetic graph paper or against a ruler.

Example

Height of red cell column 19mm

Height of total blood column 49mm

⇒ PCV = 19mm/49mm = **0.388 (1/1)** or **38.8%**

Note

The difference between duplicate determinations of a sample should not exceed 0.015 hematocrit units. Since it is difficult to measure the volume of plasma trapped between the packed red cells ('trapped plasma'), it is not customary in routine practice to correct for this trapped plasma. Its amount varies in healthy individuals 1-3% of the red cell column. It is increased in hypochromic anemia, macrocytic anemia, sickle cell anemia, spherocytosis and thalassemia.

Advantages of the Microhematocrit Method

- It enables higher centrifugation speeds with consequent shorter centrifugation times and superior packing.
- The amount of trapped plasma is less than that in the Wintrobe method by virtue of the higher centrifugation speed employed.

Sources of error

- Incomplete packing due to insufficient centrifugation. Centrifuges should be regularly checked for proper operation.
- Incorrect reading of results. A magnifying glass

Hematology

should be used with the special reading device.

- Hemolysis or clotting of samples:
 - Factors that cause hemolysis and clotting of samples should be controlled.
 - Blood samples for microhematocrit measurements should be centrifuged within 6 hours of collection.
- Occasionally, the red cell – plasma interface is not clear-cut and the hematocrit is difficult to read. In such cases repeat the test ensuring proper filling and centrifugation.
- Variation of the bore of the tubes cause serious errors if they are not manufactured within the narrow limits of precision that conform to defined standards,

Other information from the PCV

The laboratory personnel should cultivate the habit of inspecting both the buffy coat and the supernatant plasma when reading the hematocrit value. A note should be made on the patient's report if an abnormal plasma or buffy coat is seen as this is often an important clue for the clinician. Plasma from normal blood appears

straw-colored. In iron deficiency it appears color-less. When it contains an increased amount of bilirubin (as occurs in hemolytic anemia) it will appear abnormally yellow. If the plasma is pink-red this indicates a hemolyzed sample (less commonly hemoglobinemia). When white cell numbers are significantly increased, this will be reflected in an increase in the volume of buffy coat layer. When this is seen, perform a total WBC count and white cell differential count.

10.2. Macrohematocrit method

Although recommended by the ICSH as an alternative method, it is no longer in routine use because of technical problems and the centrifugation time required (at least 30 minutes) to achieve maximal packing of cells. The method uses a Wintrobe tube which can also be used to determine the erythrocyte sedimentation test. The tube is 11cm in length with an internal diameter of 2.5mm. It has two graduation scales in millimeters and with the centimeters marked by numbers. One side is graduated from 0 to 10cm (0-100mm) from the bottom to the top, while the other side is graduated from 10 to 0cm (100-0mm) from bottom to top. The earlier scale is used to determine PCV and the latter is used to measure

ESR.

Test method

1. The tube is filled with well mixed EDTA anticoagulated venous blood to the mark "0" on top using a long stem Pasteur pipette making sure that no air bubbles are trapped. The ratio of EDTA to volume of blood should be **1.5mg/ml** or 0.1ml 10%w/v K₃EDTA/ml of blood. EDTA in excess of this proportion may cause a falsely low PCV as a consequence of cell shrinkage.
2. The preparation is then spun at not less than 2300g for 30 minutes.
3. The hematocrit is read from the scale on the right hand side of the tube taking the top of the black band of reduced erythrocytes immediately beneath the reddish gray leucocyte layer.

Interpretation of PCV

In a similar way to hemoglobin levels, PCV values vary according to age, gender, and altitude. Reference ranges vary in different populations and in different laboratories. District laboratories should check the reference ranges with their nearest Hematology

Hematology

Reference Laboratory. PCV values are reduced in anemia. Increased values are found in dengue hemorrhagic fever and in all forms of polycythemia.

PCV reference range, l/l	
Children at birth	0.44-0.54
Children 2-5 y	0.34-0.40
Children 6-12 y	0.35-0.45
Adult men	0.40-0.54
Adult women	0.36-0.46

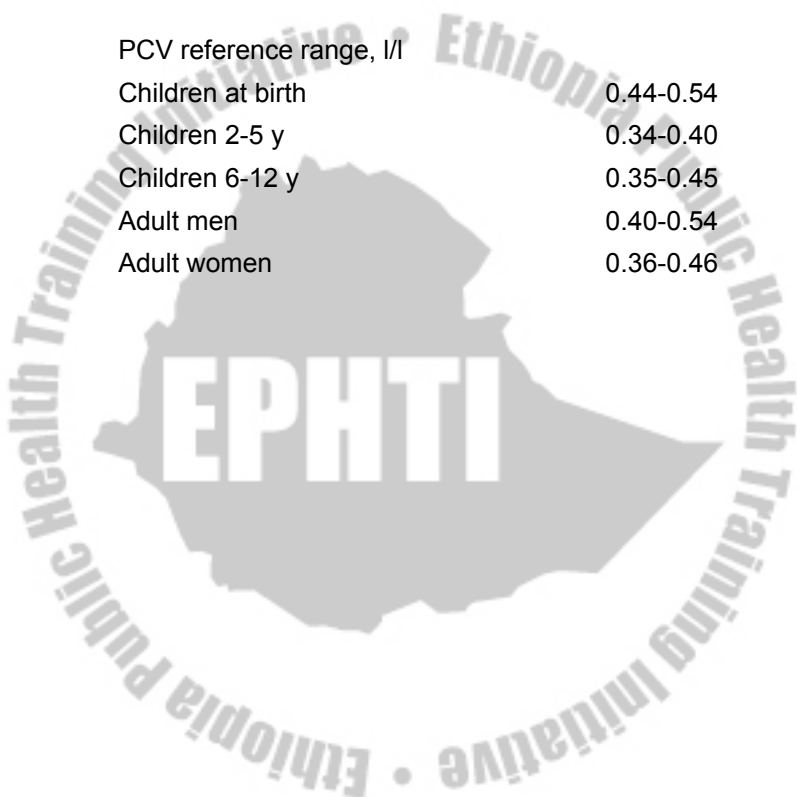

Review Questions

1. Define packed cell volume.
2. What is the significance of measuring PCV in a sample of blood?
3. List the items that are required in PCV determination using the microhematocrit method.
4. What is the advantage of the microhematocrit method of PCV determination?
5. How do you relate measured values of PCV and hemoglobin of a sample of blood?

CHAPTER ELEVEN

RED CELL INDICES

Learning objectives

At the end of this chapter, the student shall be able to:

- Define MCV, MCH, MCHC and RDW
- Explain the purpose of calculating the red cell indices
- Calculate MCV, MCH MCHC and RDW values from given patient values

Red blood cell indices are measurements that describe the size and oxygen-carrying protein (hemoglobin) content of red blood cells. They are also called red cell absolute values or erythrocyte indices. The indices are used to help in the differential diagnosis of anemia. Anemia is caused by many different diseases or disorders. The first step in finding the cause is to determine what type of anemia the person has. Red blood cell indices help to classify the anemias.

The relationships between the hematocrit, the hemoglobin level, and the RBC are converted to red

Hematology

blood cell indices through mathematical formulas. These formulas were worked out and first applied to the classification of anemias by Maxwell Wintrobe in 1934. The indices include these measurements: mean corpuscular volume (MCV); mean corpuscular hemoglobin (MCH); mean corpuscular hemoglobin concentration (MCHC); and red cell distribution width (RDW). They are usually calculated by an automated instrument as part of a complete blood count (CBC).

The most common causes of macrocytic anemia (high MCV) are vitamin B12 and folic acid deficiencies. Lack of iron in the diet, thalassemia (a type of hereditary anemia), and chronic illness are the most common causes of microcytic anemia (low MCV). Normocytic anemia (normal MCV) can be caused by kidney and liver disease, bone marrow disorders, or excessive bleeding or hemolysis of the red blood cells. Lack of iron in the diet and thalassemia are the most common causes of hypochromic anemia (low MCHC). Normocytic anemias are usually also normochromic and share the same causes (normal MCHC).

The RDW is increased in anemias caused by deficiencies of iron, vitamin B12, or folic acid. Abnormal

hemoglobins, such as in sickle cell anemia, can change the shape of red blood cells as well as cause them to hemolyze. The abnormal shape and the cell fragments resulting from hemolysis increase the RDW. Conditions that cause more immature cells to be released into the bloodstream, such as severe blood loss, will increase the RDW. The larger size of immature cells creates a distinct size variation.

11.1. Mean Cell Volume (MCV)

Mean cell volume (MCV) is the index most often used. It measures the average volume of a red blood cell by dividing the hematocrit by the RBC. The MCV categorizes red blood cells by size. Cells of normal size are called normocytic, smaller cells are microcytic, and larger cells are macrocytic. These size categories are used to classify anemias. Normocytic anemias have normal-sized cells and a normal MCV; microcytic anemias have small cells and a decreased MCV; and macrocytic anemias have large cells and an increased MCV. Under a microscope, stained red blood cells with a high MCV appear larger than cells with a normal or low MCV. It is the average volume of one red cell expressed in femtoliters(fl). One femtoliter (fl) = 10^{-15} L = 1 cubic

Hematology

micrometer (μm).

It is given by: $\text{MCV (fl)} = \frac{\text{PCV (l/l)}}{\text{No. of RBC/l}}$

Example: $\text{PCV} = 0.45(\text{l/l})$; $\text{RBC} = 5 \times 10^{12}/\text{l}$

$$\text{MCV} = \frac{0.45 (\text{l/l})}{5 \times 10^{12}} = 90 \times 10^{-15} \text{ l} = 90 \text{ fl}$$

Interpretation of results

Reference value: Men and Women: $92 \pm 9 \text{ fl}$

MCV is increased in macrocytic anemias and decreased in iron deficiency anemia, thalassemia and microcytic anemia.

9.2. Mean Cell Hemoglobin (MCH)

The average weight of hemoglobin in a red blood cell is measured by the MCH. MCH values usually rise or fall

Hematology

as the MCV is increased or decreased. It is expressed in picograms (pg). One picogram (pg) = 10^{-12}g = 1 micromicrogram ($\mu\mu\text{m}$).

It is given by:

$$\text{MCH (Pg)} = \frac{\text{Hb (g/l)}}{\text{No of RBC/l}}$$

Example: Hb conc. = 150g/l; RBC = $5 \times 10^{12}/\text{l}$

$$\text{MCH (pg)} = \frac{150}{5 \times 10^{12}} = 30 \times 10^{-12}\text{g} = 30\text{pg}$$

Interpretation of results

Reference value: Men and women: $29.5 \pm 2.5\text{pg}$

MCH is increased in macrocytic anemia and is decreased in microcytic anemia and iron deficiency anemia.

11.3. Mean Cell Hemoglobin Concentration (MCHC)

The MCHC measures the average concentration of

Hematology

hemoglobin in a red blood cell. This index is calculated by dividing the hemoglobin by the hematocrit. The MCHC categorizes red blood cells according to their concentration of hemoglobin. Cells with a normal concentration of hemoglobin are called normochromic; cells with a lower than normal concentration are called hypochromic. Because there is a physical limit to the amount of hemoglobin that can fit in a cell, there is no hyperchromic category.

Just as MCV relates to the size of the cells, MCHC relates to the color of the cells. When examined under a microscope, normal red blood cells that contain a normal amount of hemoglobin stain pinkish red with a paler area in the center. These normochromic cells have a normal MCHC. Cells with too little hemoglobin are lighter in color with a larger pale area in the center. These hypochromic cells have a low MCHC. Anemias are categorized as hypochromic or normochromic according to the MCHC index.

It is given by:

$$\text{MCHC (g/l)} = \frac{\text{Hb (g/l)}}{\text{PCV (l/l)}}$$

Example: Hb conc. = 148g/l; PCV = 0.45 (l/l)

$$\text{MCHC} = \frac{148}{0.45} = 328\text{g/l}$$

0.45

Interpretation of results

Reference value: Men and women: $330 \pm 15\text{g/l}$

MCHC is increased in some cases of hereditary spherocytosis and is decreased in iron deficiency anemia.

11.4. Red Cell Distribution Width (RDW)

The red cell distribution width (RDW) measures the variation in size of the red blood cells. Usually red blood cells are a standard size. Certain disorders, however, cause a significant variation in cell size. It is a measurement of the degree of anisocytosis present, or the degree of red cell size variability in a blood sample. This measurement is derived by the automated multiparameter instruments that can directly measure the MCV as one of the parameters determined. If anisocytosis is present on the peripheral blood film, and the variation in red cell size is prominent, then there is an increase in the standard deviation of the MCV from the mean.

Hematology

In the Coulter Model S plus, for example, a red cell histogram is plotted and the RDW(%) is defined as the coefficient of variation of the MCV:

$$\text{RDW (\%)} = \frac{\text{SD of MCV}}{\text{Mean MCV}} \times 100$$

The reference range for RDW is from 11% to 15%, but varies with the instrument used.

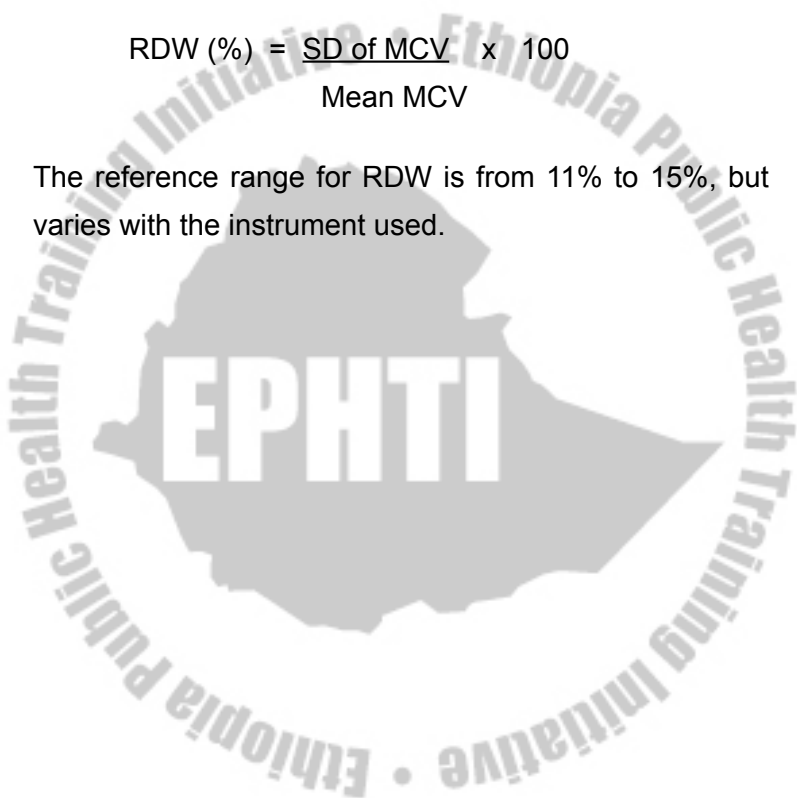

Review Questions

1. Define: MCV, MCH, MCHC, and RDW.
2. What is the purpose of calculating the red cell indices?
3. A complete blood count was performed for a patient and the following profiles were recorded:

TLC = 8,000/mm³

PCV = 50%

Hb = 15g/dl

RBC count = 5 x 10⁶/mm³

Calculate the MCV, MCH and MCHC values for the patient. Interpret your results in the light of the normal values for these indices.

CHAPTER TWELVE

ERYTHROCYTE SEDIMENTATION RATE

Learning objectives

At the end of this chapter, the student shall be able to:

- Define erythrocyte sedimentation rate
- Describe the methods of performing erythrocyte sedimentation rate
- Explain the stages in ESR
- Discuss the factors that affect ESR
- Indicate the normal values of ESR clinical implications of ESR determination

When well-mixed venous blood is placed in a vertical tube, erythrocytes will tend to fall toward the bottom. The length of fall of the top of the column of erythrocytes in a given interval of time is called the erythrocyte sedimentation rate (ESR). The rate is expressed in mm/hr.

The ESR is one of the oldest laboratory tests still in use.

Although some of its usefulness has decreased as more specific methods of evaluating diseases (such as C-reactive protein [CRP]) have been developed, new clinical applications are being reported. Recently, the ESR has been reported to be of clinical significance in sickle cell disease (low value in absence of painful crisis, moderately increased one week into crisis); osteomyelitis (elevated, helpful in following therapy); stroke (ESR of ≥ 28 has poorer prognosis); prostate cancer (ESR ≥ 37 mm/h has higher incidence of disease progression and death), and coronary artery disease (ESR > 22 mm/h in white men had high rise of CAD).

In pregnancy, the ESR increases moderately, beginning at the tenth to twelfth week, and returns to normal about one month postpartum. The ESR tends to be markedly elevated in monoclonal blood protein disorders such as multiple myeloma or macroglobulinemia, in severe polyclonal hyperglobulinemias due to inflammatory disease, and in hyperfibrinogenemias. Moderate elevations are common in active inflammatory disease such as rheumatoid arthritis, chronic infections, collagen disease, and neoplastic disease. The ESR has little diagnostic value in these disorders, but can be useful in monitoring disease activity. It is simpler than

measurement of serum proteins, which has tended to replace the ESR. Because the test is often normal in patients with neoplasm, connective tissue disease, and infections, a normal ESR cannot be used to exclude these diagnostic possibilities.

Principle

The ESR is determined by filling a narrow tube of predetermined length and bore, with well mixed anticoagulated blood, placing it in a vertical position for a set time at the end of which the distance from the top of the column to the interface between the plasma and the sedimented red cells is recorded and expressed in mm/unit time.

Stages in ESR

Erythrocyte sedimentation takes place in three stages.

1. An initial period of a few minutes (approximately 10 minutes) during which rouleaux formation takes place
2. A period of approximately 40 minutes during which settling or sedimentation occurs at a more or less constant rate. This is the most significant phase.
3. A slower rate of fall (last 10 minutes) during which

packing of the sedimented red cell column occurs. Two basic methods have been recommended and have gained wide acceptance. These are the Westergren and Wintrobe methods.

12.1. Westergren method

This is ICSH (International Council for standardization in Hematology) reference method for ESR determination.

Materials

- Westergren-Katz tube: an open glass tube with an overall length of 300mm and bore of 2.5mm. The graduated portion measures 200mm.
- Westergren rack / stand
- Trisodium citrate, 30.88g/l
- Rubber teat or pipette filler

Test method

1. Venous blood is diluted accurately in the proportion of one volume of citrate to four volumes of blood. The blood may be directly collected into the citrate solution or an EDTA anticoagulated blood used. Mix

thoroughly by gentle repeated inversion. ESR preparations should preferably be set up within 2 hrs of collection, but under extenuating circumstances may be refrigerated overnight at 4°C before testing.

2. A clean dry Westergren-Katz tube is carefully filled and adjusted to the "0" mark on top.
3. The tube is placed in a strictly vertical position in the Westergren stand under room temperature conditions not exposed to direct sunlight and away from vibrations and draughts. Allow it to stand for exactly 1 hour.
4. After 1 hour read to the nearest 1mm the height of the clear plasma above the upper limit of the column of sedimenting red cells. A poor delineation of the upper layer of red cells, the so-called 'stratified sedimentation', has been attributed to the presence of many reticulocytes. The result is expressed as ESR = X mm in 1 hour or ESR (WESTERGREN 1HR) = X mm.

Advantages of the method

It more reliably reflects the clinical state and is the most sensitive method for serial study of chronic diseases, e.g., tuberculosis.

Disadvantages of the method

It requires a large amount of blood and involves dilution which may be one source of error.

Interpretation of results

Reference value Men: 0-15mm/hr; Women: 0-20mm/hr

There is a progressive increase with age because of the decline in plasma albumin concentration. The ESR increases in pregnancy as there is a decrease in plasma albumin due to hypovolemia and an increase in concentration of α -globulin and fibrinogen.

12.2. Wintrobe Method

It uses a tube closed at one end, 11cm long with a bore of 2.5mm and having a graduated scale from 0-100mm and a special Wintrobe rack.

Test method

1. Blood is collected with EDTA in the right proportion.
2. Enough blood to fill the Wintrobe tube (approximately 1ml) is drawn into a Pasteur pipette having a long stem.
3. The Wintrobe tube is then filled from the bottom up

Hematology

(so as to exclude any air bubbles) to the "0" mark.

4. The tube is placed in the Wintrobe rack in exactly vertical position and the time is noted.
5. At the end of 1 hour the ESR is read as the length of the plasma column above the cells and is expressed as x mm/hr.

Advantages of the method

- The method is simple, requires a small amount of blood and there is no dilution.
- With the same preparation, once the ESR has been read, the hematocrit value can be determined.
- Microbilirubin determined can be made on supernatant plasma and smears of buffy coat can be made.

Disadvantages of the method

- Because of the short column, it is only sensitive when the ESR is low and when the disease is in the acute stage.

Interpretation of results

Reference value

Men: 0-7mm/hr

Women: 0-15mm/hr

Although normal ESR can not be taken to exclude the presence of organic disease, the fact remains that the vast majority of acute or chronic infections and most neoplastic and degenerative diseases are associated with changes in the plasma proteins which lead to an acceleration of the sedimentation rate.

Factors affecting ESR

I. Effect of plasma proteins

The relationship between plasma proteins and rouleaux formation is the basis for measurement of ESR as a non-specific test of inflammation and tissue damage. Red cells possess a net negative charge (zeta potential) and when suspended in normal plasma, rouleaux formation is minimal and sedimentation is slow. Alterations in proportions and concentrations of various hydrophilic protein fractions of the plasma following tissue injury or in response to inflammation reduce the zeta potential and increase the rate of rouleaux formation and the size of the aggregates thus increasing the rate of sedimentation.

The ESR shows a linear relationship with the concentration of fibrinogen and alpha and beta globulins. In most acute infections and chronic pathological processes these fractions are increased thus enhancing the ESR. Albumin which tends to counteract rouleaux formation diminishes in concentration (hypoalbuminemia) further increasing the sedimentation rate.

II. Influence of plasma viscosity

The ESR and plasma viscosity in general increase in parallel. However, plasma viscosity may increase to the extent of masking the rouleaux forming property of the plasma proteins.

III. Effect of red cell factors

Efficient rouleaux formation depends on the red cells having normal shape and size. Anisocytosis and poikilocytosis will reduce the ability of the red cells to form large aggregates thus reducing the sedimentation rate. Anemia by altering the ratio of red cells to plasma encourages rouleaux formation and accelerates sedimentation. In anemia too, cellular factors may affect sedimentation. Thus in iron deficiency anemia a

reduction in the intrinsic ability of the red cells to sediment may compensate for the accelerating effect of an increased proportion of plasma.

IV. Effect of mechanical influences

The conditions under which the ESR is performed may influence the results. Perpendicularity of the sedimentation tube—slight deviations from the vertical will increase the rate of sedimentation. A 3° inclination can increase the ESR by 30%. Vibration can reduce the ESR by retarding the rate of rouleaux formation. However, the vibration that might be encountered in practice, e.g., by a centrifuge on the same page, has been shown to have a very limited influence on results.

V. Effect of temperature

Higher temperatures cause falsely elevated results due to a reduction in plasma viscosity. Nevertheless, variation in the ambient temperature of a laboratory is unlikely to be a significant problem unless the tubes are exposed to direct sunlight.

Review Questions

1. Define erythrocyte sedimentation rate.
2. What is the principle of ESR determination?
3. What are the stages in ESR as occur in a tube filled with an appropriately diluted sample of blood?
4. List the items required in ESR determination using the Westergren method.
5. What is the clinical significance of measuring ESR?

CHAPTER THIRTEEN

OSMOTIC FRAGILITY OF THE RED CELL

Learning objectives

At the end of this chapter, the student shall be able to:

- Define osmotic fragility
- State the principle of the osmotic fragility test
- Prepare different graded strength of sodium chloride solution required for the osmotic fragility test
- Describe the interpretation of the osmotic fragility test

Introduction

The red cell envelope is a semi permeable membrane. When red cells are placed in a hypotonic solution they imbibe fluid and thereby swell. It follows then that there is a limit to the hypotonicity of a solution that normal red cells can stand. Although the osmotic fragility test depends upon osmosis, the actual rupture of the cell results from alteration of its shape and diminished

resistance to osmotic forces rather than a change in the composition of the cell or its osmolarity.

Cells that are spherocytic rupture more easily than others and indeed the OFT may be regarded as the most sensitive index of the extent and degree of spherocytosis. Conversely, increased resistance against lysis in hypotonic solution is shown in red cells in thalassemia, sickle cell anemia and hypochromic (iron deficiency) anemia. Probably the cells in these conditions have a greater surface area to volume ratio.

Parpart and Co-workers method of determination

Principle

Test and normal red cells are placed in a series of graded - strength sodium chloride solutions and any resultant hemolysis is compared with a 100% standard.

Reagent

Stock 10% Sodium Chloride solution

Dilutions

Hematology

These may be prepared in 50-ml amounts and stored at 4°C for up to 6 months or may be prepared just before the test. It is convenient to make a 1% solution from the stock 10% and proceed as follows:

Tube No	MI of 1%	MI of dist.	% buffered
	NaCl	water	NaCl
1	0.50	4.50	0.10
2	1.00	4.00	0.20
3	1.50	3.50	0.30
4	1.75	3.25	0.35
5	2.00	3.00	0.40
6	2.25	2.75	0.45
7	2.50	2.50	0.50
8	2.75	2.25	0.55
9	3.00	2.00	0.60
10	3.25	1.75	0.65
11	3.50	1.50	0.70
12	4.00	1.00	0.80

Procedure

1. Mix the contents of each tube before adding the blood. If dilutions have already been prepared in bulk, place 5ml of the appropriate salt dilution in

Hematology

each tube. The 12 dilutions are set up in duplicate.

2. The patient's blood and a normal control specimen are taken with minimum of stasis and trauma into heparinized tubes. Each sample is gently rotated in the tube until it is bright red (fully oxygenated). A carefully defibrinated blood may be used or an EDTA – anticoagulated blood may be used since the added EDTA in 0.02ml of blood has a negligible effect on the final tonicity. The test should be performed within 2 hours of sample collection or up to 6 hours if the blood is kept at 4°C.
3. To each of the 12 tubes in one row (marked 'test') is added 0.02ml of patient's blood. If the hemoglobin concentration of the blood is below 10.5g/dl, 0.05ml amounts are added to each tube.
4. Similar amounts of the normal control blood are placed in the second row of tubes (marked 'control').
5. Mix each tube well.
6. Let stand at room temperature for 30 minutes. Then remix and centrifuge at 1000G for 10 minutes.
7. Using a spectro- or colorimeter at 540nm, measure the absorbances of the supernatants using tube no. 12 of the test and control as blanks for the respective rows. For the reading the supernatant of each tube must be removed carefully so as not to

Hematology

include any cells. Tube number 1 in each case is the 100% hemolysis standard.

Calculation

Example

Absorbance of tube No. 12 (blank) = 0.00

Absorbance of tube No. 1 (100%) = 0.40

Absorbance of tube No. 5 = 0.20

$$\% \text{ hemolysis of tube No. 5} = \frac{0.200 - 0.00}{0.400 - 0.00} \times 100 = 50\%$$

Reporting of Results

The red cell fragility is best reported as a curve on a linear graph paper, always including the normal control and indicating the salt concentrations in which: (1) hemolysis begins, (2) hemolysis is complete, and (3) 50% hemolysis occurred.

Review Questions

1. What is the basis of measuring osmotic fragility of the red cell in a sample of blood?
2. How do you report and interpret the results of the osmotic fragility test?

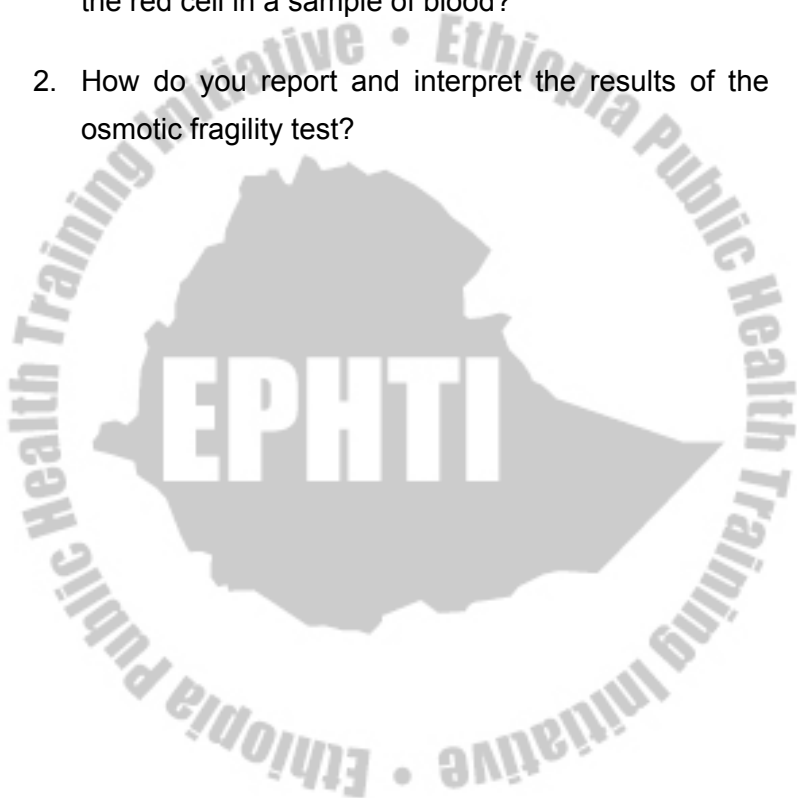

CHAPTER FOURTEEN

BONE MARROW SMEAR

EXAMINATION

Learning objectives

At the end of this chapter, the student shall be able to:

- Mentions the methods of obtaining bone marrow sample for examination
- Indicate the anatomical sites of bone marrow aspiration in infants, children and adults
- Prepare bone marrow smears on slides
- Identify and discuss the elements of the bone marrow architecture that should be assessed during bone marrow examination
- Perform assessment of stained bone marrow smears

Introduction

Bone marrow examination refers to the pathologic analysis of samples of bone marrow obtained by bone marrow biopsy (often called a trephine biopsy) and bone marrow aspiration. Bone marrow examination is used in

Hematology

the diagnosis of a number of conditions, including leukemia, multiple myeloma, and anemia. The bone marrow produces the cellular elements of the blood, including platelets, red blood cells and white blood cells. While much information can be gleaned by testing the blood itself (drawn from a vein), it is sometimes necessary to examine the source of the blood cells in the bone marrow to obtain more information on hematopoiesis; this is the role of bone marrow aspiration and biopsy. It is estimated that the weight of the marrow in the adult is 1300 to 1500g.

Samples of bone marrow can be obtained by:

- Aspiration using a special needle and syringe, e.g., Salah, Klima, and Islam's aspiration needles.
- Percutaneous trephine biopsy.
- Open surgical biopsy or open trephine that requires full operating theatre practice.

Most bone marrow samples for hematological purposes are obtained by aspiration often combined with needle or trephine biopsy. The aspiration procedure is simple, safe and relatively painless.



Fig 14.1 A needle used for bone marrow aspiration, with removable stylet.

Biopsy and Aspiration sites

The site selected for the aspiration depends on: the age of the patient, and whether or not a needle or trephine biopsy is required.

In adults active marrow is normally confined to the

central skeleton and the convenient sites are:

- The sternum: the best site when aspiration only is needed as it is the easiest to puncture and considered to yield the most cellular samples. A disadvantage is that the patient has a clear view of the procedure which may cause distress.
- Anterior or posterior iliac spines which have the advantage that if no material is aspirated, a microtrephine biopsy can be performed immediately.



Fig 14.2: Bone marrow samples are usually taken from the hipbone (iliac crest). The person may lie on one side, facing away from the doctor, with the knee of the top leg bent. After numbing the skin and tissue over the bone with a local anesthetic, the doctor inserts a needle into the bone and withdraws the marrow.

Hematology

In infants and children the sternum is naturally thin and an alternative site is preferred.

- Under 12 years: iliac crest
- Under 2 years: the presence of active marrow in the long bones makes the proximal anterior portion of the tibia a possible site.

In disorders associated with replacement of hemopoietic marrow by other tissues or cells (e.g., malignancies in the bone marrow), marrow aspiration may be difficult or impossible ('dry tap'). In such cases, a needle or trephine biopsy is essential. A minimum amount of marrow should be aspirated. Volumes over 0.5ml will almost certainly be diluted with blood making processing and interpretation more difficult.

Bone marrow films

Careful preparation is essential and it is desirable, if possible, to concentrate the marrow cells at the expense of the blood in which they are diluted.

Method

1. Deliver single drops of aspirate on to slides about 1cm from one end and then quickly suck off most of

the blood with a fine Pasteur pipette applied to the edge of each drop. Alternatively, place the slides on a slope to allow the blood to drain away. The irregularly shaped marrow fragments tend to adhere to the slide and most of them will be left behind.

2. Make films 3-5cm in length, of the marrow fragments and the remaining blood using a smooth-edged glass spreader of not more than 2cm in width. The marrow fragments are dragged behind the spreader and leave a trail of cells behind them. It is in these cellular trails that the differential counts be made commencing from the marrow fragments and working back towards the head of the film; in this way, smaller numbers of cells from the peripheral blood become incorporated in the differential count. The preparation can be considered satisfactory only when marrow particles as well as free marrow cells can be seen in stained films.
3. Fix the films of bone marrow and stain them with Romanowsky dyes as for peripheral films. However, a longer fixation time (at least 20 minutes in methanol) is essential for high quality staining. The staining time should also be increased if the marrow is hypercellular.

Particle/Crush Smears

Some workers isolate aspirated marrow particles and make crush preparations by gentle pressure of a second slide combined with the sliding apart of the two slides either in one movement or by a series of interrupted movements. While the technique gives preparations of authentic marrow cells, squashing and smearing out the particles causes disruption and distortion of cells and the resultant thick preparations are difficult to stain well.

Examination and Assessment of Stained Bone marrow Preparations

The first thing to do is to look with the naked eye at a selection of slides and to choose from them the best spread films containing easily visible marrow particles. The particles should then be examined with a low power objective with particular reference to their cellularity and an estimate of whether the marrow is hypoplastic, normoplastic or hyperplastic.

Cellularity of Marrow

The marrow cellularity is expressed as the ratio of the volume of hematopoietic cells to the total volume of the marrow space (cells plus fat and other stromal

elements). It is judged by comparing the areas occupied by fat spaces and by nucleated cells in the particles. Cellularity varies with the age of the subject and the site. For example, at age 50 years, the average cellularity in the vertebrae is 75%; sternum, 60%; iliac crest, 50%; and rib, 30%. Normal marrow is normocellular or normoplastic. If the percentage is increased for the age of the patient, the marrow is said to be hypercellular or hyperplastic. Such hypercellular marrow is seen in myeloproliferative disorders (e.g., CGL, AML), lymphoproliferative disorders (e.g., ALL, CLL), infections and polycythemia. If the percentage is decreased for the age of the patient, the marrow is said to be hypocellular or hypoplastic. It is a finding in conditions associated with marrow failure, e.g., aplastic anemia or toxicity (drugs, chemicals).

Myeloid to Erythroid Ratio (M:E Ratio)

The myeloid/erythroid (M/E) ration is the ratio of total granulocytes to total normoblasts. This is used as an expression of the myeloid and erythroid compartments relative to each other and is calculated after classifying at least 200 cells (leucocytes of all types and stages of maturation are counted together). In normal adult bone marrow, the myeloid cells always outnumber the

erythroid cells with a mean value of 4:1. An increased M:E ratio shows an increase in the number of leucocytes and depression of the erythroid series while a decrease in the ratio shows the presence of erythroid hyperplasia and suppression of granulocytes.

Differential Count on Aspirated Bone marrow: the Myelogram

Expression of the incidence of the various cell types as percentages is not a mandatory part of bone marrow examination because of the relatively long time required to perform the count and the little clinical usefulness of such an effort. The count is also unreliable due to irregular distribution of the marrow cells and inclusion of cells from the peripheral blood for which there is no compensation. If at all to be attempted, a minimum of 200 cells should be studied.

Because of the naturally variegated pattern of the bone marrow and the regular distribution of the marrow cells, differential counts on marrow from normal subjects vary so widely that minor degrees of deviation from the normal occurring in disease are difficult to establish.

Hematology

Table 14.1 Differential cell counts of bone marrow in percent of total nucleated cells in adults

Type of cell	Percentage	Type of cell	Percentage
Myeloblasts	0 - 3.5	Pronormoblasts	0-3
Promyelocytes	0 - 6	Basophilic normoblasts	1 - 5
Myelocytes	8 - 15	Polychromatophilic normoblasts	5 - 20
Metamyelocytes	9 - 25	Orthochromatic normoblasts	1 - 15
Band and segmented:	15 - 27	Lymphocytes + Precursors	3 - 20
Neutrophils	7 - 25	Plasmacytes + precursors	0 - 3.5
Eosinophils	0 - 4	Monocytes + precursors	0 - 2
Basophils	0 - 1	M:E Ratio	1.5 - 5.2

Review Questions

1. Indicate the sites of bone marrow aspiration in: adults, children under 12 years of age and children less than 2 years of age.
2. What elements of the stained bone marrow architecture are mainly assessed in bone marrow examination?

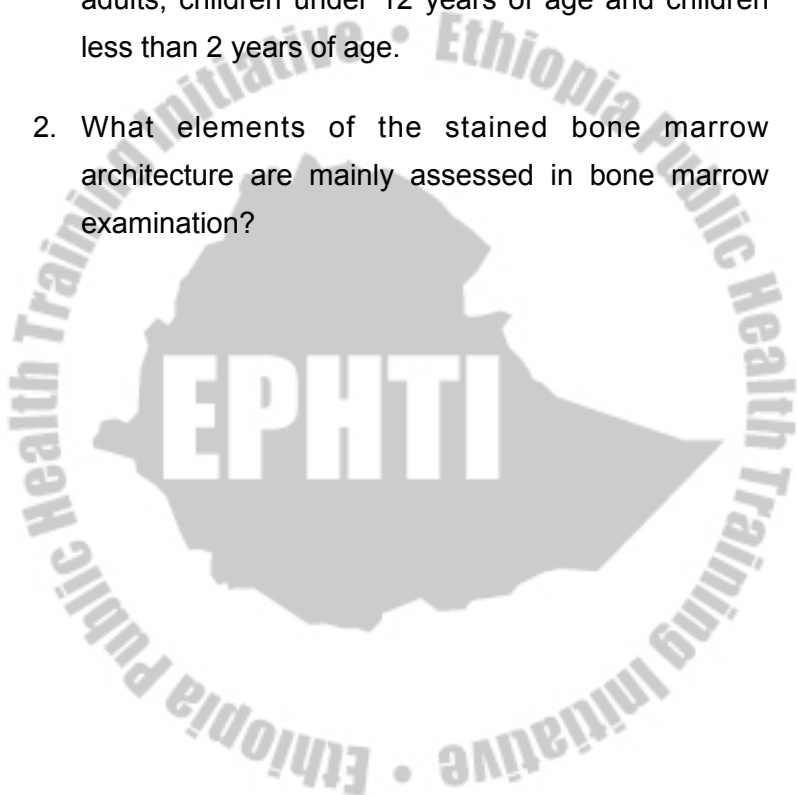

CHAPTER FIFTEEN

LUPUS ERYTHEMATOSUS CELL

Learning objectives

At the end of this chapter, the student shall be able to:

- Explain the LE cell phenomenon
- Describe the methods for demonstration of LE cell
- Perform the demonstration of LC cell

Introduction

Systemic Lupus Erythematosus (SLE) is a chronic (long-lasting) rheumatic disease which affects joints, muscles and other parts of the body. Lupus involves inflammation (the immune system's response to kill foreign agents, virus, bacteria). Systemic lupus erythematosus involves chronic inflammation that can affect many parts of the body, including: Heart, lungs, skin, joints, blood-forming organs, kidneys, nervous system. It is a connective tissue disease that affects most commonly women of child bearing age and is characterized by skin rash, arthralgia, fever, renal, cardiac and vascular lesions, anemia, leucopenia and often thrombocytopenia. There

Hematology

is a factor in the serum (an immunoglobulin of the IgG, IgM or IgA class) that has the ability to cause depolymerization of the nuclear chromatin of polymorphonuclear leucocytes and this depolymerized material is subsequently phagocytosed by an intact polymorph giving rise to the Lupus erythematosus (LE) cell.

The LE cell is usually a neutrophil polymorph (occasionally a monocyte or eosinophil) that has ingested the altered nucleus of another polymorph. The bulk of the cell is occupied by a spherical, homogeneous mass that stains purplish brown. The lobes of the ingesting polymorph appear wrapped around the ingested material. Occasionally, a group of polymorphs will collect around an altered nuclear material and will form a "rosette".

Who Is At Risk?

- Lupus affects women about 8 to 10 times as often as men and often occurs around the ages of 18 to 45.
- Lupus occurs more often in African Americans.

Hematology

- Lupus can occur in young children or in older people.
- Studies suggest that certain people may inherit the tendency to get lupus. New cases of lupus are more common in families where one member already has the disease.

Demonstration of LE cells

Many methods for demonstrating LE cells have been described. It seems clear that some degree of trauma to leucocytes is necessary for a successful preparation for the LE factor does not appear to be capable of acting upon healthy living leucocytes. A good method of achieving the necessary degree of trauma is to rotate the whole blood sample to which glass beads have been before concentrating the leucocytes by centrifugation.

Method Using Patient's Blood

The Rotary Method of Zinkham and Conley

1. 1ml of patient blood collected in heparin is transferred into a 75 x 12mm glass tube.
2. Four glass beads are added and the tube is sealed with a tightly fitting rubber bung.
3. The preparation is rotated at 33 rpm at room temperature for 30 minutes and placed at 37°C for

Hematology

10-15 minutes.

4. The contents of the tube are transferred to a Wintrobe tube and centrifuged at 200g for 10 minutes.
5. Buffy coat smears are prepared, dried in the air, fixed in methanol and are stained with Romanowsky stain in the usual manner.

Examination of Films

The films, especially their edges and tails are searched for a minimum of 10 minutes (a minimum of 500 polymorphs should be counted) before a negative report is given. Frequently, dead nuclei will be seen lying freely; if numerous, these may heighten suspicions but they are never diagnostic. LE cells must be differentiated from "tart cells" which are usually monocytes that have phagocytosed the nucleus of a lymphocyte. The ingested nuclear material is well preserved in contrast to the LE cell inclusion body. Tart cells are often associated with leucoagglutinins and may occasionally occur in patients on drug therapy.

Interpretation

A positive LE cell test is very suggestive of SLE and the test is a very useful diagnostic test. The test is positive

Hematology

in 75% of patients with SLE. However, false positive results have been reported in lupoid hepatitis, patients with severe and highly active rheumatoid arthritis and patients on drug therapy.



Review Questions

1. Explain the LE cell phenomenon.
2. Describe the interpretation of LE Cell

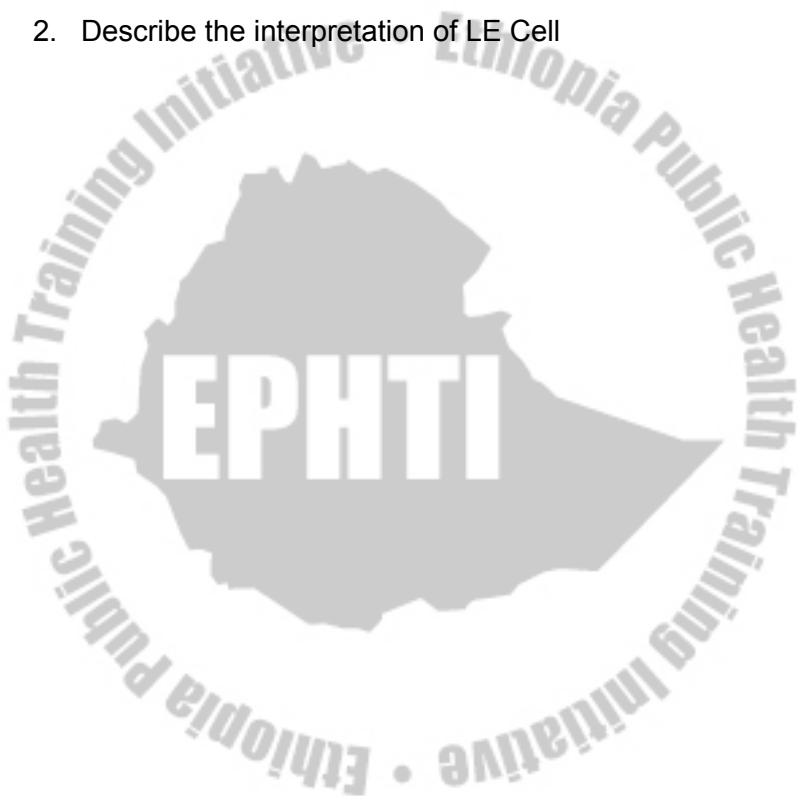

CHAPTER SIXTEEN

RED CELL MORPHOLOGY STUDY

Learning objectives

At the end of this chapter, the student shall be able to:

- Describe the morphology of normal red cells
- List and describe the different abnormal erythrocyte forms
- Assess the morphology of red cells on a stained blood film
- Describe the grading system for assessing changes in erythrocyte morphology

Introduction

The morphology of blood cells in stained films is the basis of laboratory diagnosis of hematological disorders. A careful examination of a well spread and well stained film by an experienced observer can be more informative than a series of investigations. First the film should be covered with a cover glass using a neutral medium as a mountant. Next it should be inspected under low power magnification in order:

- To get an idea of the quality of the preparation, i.e., whether red cell agglutination or excessive rouleaux is present.
- To get an idea of the number, distribution and staining of the leucocytes.
- To find an area where the red cells are evenly distributed and are not distorted.

Having selected a suitable area, the 40x dry or 100 x oil immersion objectives is used to appreciate variation in red cell size, shape and staining and fine details such as cytoplasmic granules and other red cell inclusions.

Normal Mature Red Cells (Discocytes)

In health, red cells are said to be normocytic and normochromic. In well spread and stained films the great majorities of the cells have round smooth contours and have diameters within the comparatively narrow range of 6.0-8.0 μm . They have a thickness of 2.5 μm at the periphery and 1.0 μm in the center. As a rough guide, normal red cell size appears to be about the same as that of the nucleus of a small lymphocyte. The hemoglobin stains with the eosin component of Romanowsky dyes and owing to the biconcavity of the cell, stains more palely at the center and quite deeply at

the periphery. This depth and distribution of staining in normal red cells is described as normochromic.

Size variation (Anisocytosis)

- **Macrocytes**

Macrocytes have diameter greater than $8.0\mu\text{m}$ and the mean cell volume is also increased. Because of their increased hemoglobin content they stain darker than discocytes. Macrocytosis is seen in stress erythropoiesis as seen in hemolytic anemia and also during recovery from acute blood loss.

- **Megalocytes**

Large (greater diameter may measure $12\mu\text{m}$), often oval shaped cells with increased hemoglobin content. True megalocytes are identified only if megaloblasts have been identified in bone marrow aspirates. Megalocytes are seen in vitamin B₁₂ and/or folic acid deficiency, in association with some leukemias and in refractory anemias.

- **Microcytes**

Microcytes have diameter less than $6.0\mu\text{m}$ but may appear to have normal size caused by flattening of the cells during smear preparation. The mean cell

volume is decreased to less than 80fl. The area of central pallor usually increases because of the coexistent hypochromia. It is seen in iron deficiency anemia and a slight degree of microcytosis is seen in inflammation.

Variation in Shape (Poikilocytosis)

- **Acanthocytes (spiny cells)**

Spheroidal cells with 3-12 spicules of uneven length irregularly distributed over the cell surface. It is seen in disorders of lipid metabolism, alcoholic liver cirrhosis and rarely in hepatitis.

- **Dacrocytes (Tear drop cells)**

These are tear drop or pear shaped red cells which could be considered to be discocytes with a single drawn out spicule. It is thought that stretching of the cell membrane beyond a certain limit results in loss of deformability and ability to revert to normal discoid shape. It is seen in myelofibrosis, myeloid metaplasia, tumor metastases to the bone marrow, tuberculosis and drug-induced Heinz body formation

- **Drepanocytes (sickle cells)**

These are crescent shaped red cells because of the formation of rod-like polymers of Hb S or some other rare hemoglobins. They have an increased surface

area and increased mechanical fragility which leads to hemolysis and hence severe anemia. They are primarily seen in sickle cell anemia where there is substitution of valine for glutamic acid at position 6 of the beta chain.

- **Echinocytes (crenated cells)**

Red cells showing numerous, short, evenly distributed spicules of equal length. These are probably the most common artefacts in a blood film consistently found in blood samples that have been stored for some time room temperature and because of diffusion of alkaline substances from the slide into the cells resulting in an increase in pH and thus crenation of the cells. In vivo they are seen in uremia, pyruvate kinase deficiency and neonatal liver diseases.

- **Elliptocytes/ ovalocytes**

They are elliptical or oval shaped red cells. Normally less than 1% of the red cells are elliptical/oval shaped. They are found in almost all anemias where approximately 10% of the red cells may assume elliptical/oval shape and in hereditary elliptocytosis where almost all the red cells are elliptical.

- **Schistocytes (fragmented cells)**

Two types can be distinguished in this circumstance. The first one is small fragments of cells of varying shape, sometimes with sharp angles or spines (e.g. spur cells), sometimes round in contour, usually staining deeply but occasionally palely as a result of loss of hemoglobin at the time of fragmentation. The other type is larger cells mainly with round contour from which fragments have been split off, e.g. helmet cells. They are seen in certain genetically determined disorders (e.g. thalassemias and hereditary elliptocytosis), acquired disorders of red cell formation, megaloblastic and iron deficiency anemias and during direct thermal injury as in severe burns.

- **Burr cells**

They are small cells or cell fragments bearing one or a few spines. They are found particularly in uremia.

- **Leptocytes (target cells/Mexican hat cells)**

These are cells showing an area of central staining which are abnormally thin cells. They are common findings in obstructive liver diseases where there is accumulation of cholesterol and lecithin due to inhibition of plasma LCAT activity by bile salts.

Variable numbers are seen in iron deficiency anemia and thalassemia. There is gross target cell formation after splenectomy.

- **Stomatocytes**

These are cells with a narrow slit like area of central pallor. They are common findings in liver diseases associated with chronic alcohol abuse.

- **Spherocytes/Microspherocytes**

These are dense staining spherical cells with smaller diameter and greater thickness than normal. They are formed as a result of loss of membrane due to chemicals, bacterial toxins, antibody-mediated hemolytic anemias. They are commonly seen in hereditary spherocytosis that is associated with abnormalities in membrane protein, lipid loss and excessive flux of Na^+ across the membrane.

- **Rouleaux formation**

These are red cells are aligned in formations resembling stacks of coins and may be seen as artifacts in the thick areas of the blood film. They are often associated with hyperproteinemia, chronic inflammatory disorders, multiple myeloma, macroglobulinemia.

Abnormalities in Red cell Hemoglobinization

- **Hypochromia/ Hypochromasia**

Hypochromic red cells contain less than the normal amount of hemoglobin and hence the central pale area is increased to more than one-third of the cell diameter. In severe hypochromia the hemoglobin appears as a thin rim at the periphery of the cell. The cells are usually microcytic and assume target shape. It is a consistent finding in iron deficiency anemia, thalassemia and sideroblastic anemia. In doubtful cases it is wise to compare the staining of the suspect film with that of a normal film stained at the same time. Poor drying of the film may cause a 'false hypochromia'. This can be distinguished from a true one in that the change in the central pale area is sudden while in true hypochromia it is gradual.

- **Hyperchromia/ Hyperchromasia**

Because over saturation of a red cell can not take place, true hyperchromia does not exist. Usually deep staining of red cells is seen in macrocytosis when the red cell thickness is increased and the mean cell volume also increased and in spherocytes in which the red cell thickness is greater than normal and the mean cell hemoglobin concentration is slightly increased.

- **Polychromasia/ Polychromatophilia**

As reticulocytes contain residual RNA they will have the affinity for the basic component of the Romanowsky stains and assumes a degree of blue staining proportional to the amount of RNA. An increase in reticulocytes in the peripheral blood will be seen as a polychromatic red cell population which is also macrocytic.

- **Dimorphism/Anisochromasia**

This is the presence of two populations of red cells, namely hypochromic and normochromic, in the same film in approximately equal proportions. It is a finding in treated iron deficiency anemia where there is the new normochromic red cell population and the original hypochromic population and in patients with hypochromic anemia who have been transfused.

Red cell inclusions

- **Basophilic stippling/Punctate basophilia**

The red cells contain small irregularly shaped granules which stain blue in Wright stain and which are found distributed throughout the cell surface. It is a common finding in: lead poisoning anemias associated with disorders of hemoglobin synthesis

- **Howell-Jolly bodies**

Small, round inclusions that contains DNA and is usually eccentrically located in the cell. They stain deep purple. Found in megaloblastic anemia, some hemolytic anemias and after splenectomy.

- **Cabot's rings**

These are incomplete or complete rings, even figures of '8', that appear as reddish - violet fine filamentous configuration in Wright- stained films. They are remnants of the microtubules of the mitotic spindle.

- **Blood Parasites**

E.g. malaria, babesia

Grading system for assessing changes in erythrocyte morphology

The following system enables standard reporting by individual technologists:

Mean number of abnormal RBC/ HPF	Score
3 – 6	+ (slight)
7 – 10	++ (moderate)
11 – 20	+++ (marked)
> 20	++++ (marked)



Review Questions

1. What parameters of the red cell morphology are appraised in red cell morphology study on a stained blood film? Supplement your answers with examples.
2. Describe the standard grading system used to evaluate changes in erythrocyte morphology on a stained blood film? Give examples.

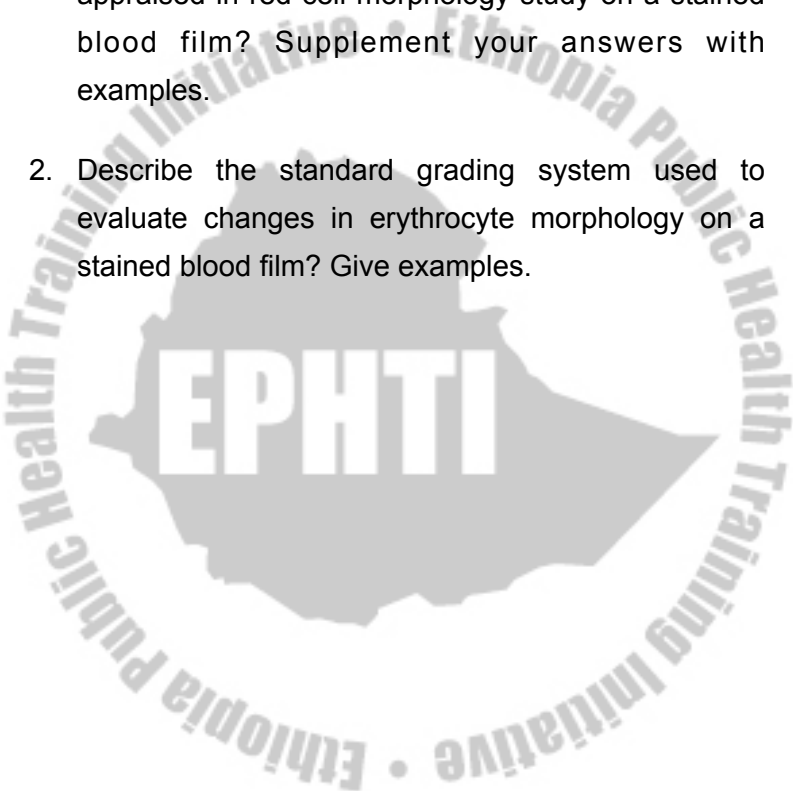

CHAPTER SEVENTEEN

ANEMIA

Learning objectives

At the end of this chapter, the student shall be able to:

- Define anemia
- Describe the classification of anemia
- Explain microcytic anemia
- Describe macrocytic anemia
- Describe normochromic normocytic anemia

Introduction

Anemia is a condition in which the amount of hemoglobin in a patient's circulatory system is reduced. A physiologic definition stresses the inability of an anemic individual to maintain normal tissue oxygenation. This may result from decreased hemoglobin content or reduced red cell number.

Alterations in total circulating plasma volume as well as of total circulating hemoglobin mass determine the hemoglobin concentration. Reduction in plasma volume

(as in dehydration) may mask anemia or even cause polycythemia; conversely, an increase in plasma volume (as with splenomegaly or pregnancy) may cause anemia even with a normal total circulating red cell and hemoglobin mass. After acute major blood loss, anemia is not immediately apparent since the total blood volume is reduced. It takes up to a day for the plasma volume to be replaced and so for the degree of anemia to become apparent. Regeneration of the hemoglobin mass takes substantially longer. The initial clinical features of major blood loss are, therefore, due to reduction in blood volume rather than to anemia.

Clinical features

If the patient does have symptoms, these are usually shortness of breath (particularly on exercise), weakness, lethargy, palpitation and headaches. In older subjects symptoms of cardiac failure, angina pectoris or intermittent claudication or confusion may be present. Visual disturbances due to retinal hemorrhages may complicate very severe anemia, particularly of rapid onset. The signs may be divided into general and specific.

General signs include pallor of mucous membrane

which occurs if the hemoglobin level is less than 9-10g/dl. Skin color, on the other hand, is not a reliable sign of anemia; the state of the skin circulation rather than the hemoglobin content of the blood largely determined skin color. Specific signs are associated with particular types of anemia, e.g. koilonychia (spoon nails) with iron deficiency, jaundice with hemolytic or megaloblastic anemias, leg ulcers with sickle cell and other hemolytic anemia, bone deformities with thalassemia major and other severe congenital hemolytic anemias. The association of features of anemia with excess infections or spontaneous bruising suggests that neutropenia or thrombocytopenia may also be present.

Classification of anemias

Many different classification of anemia have been proposed. In Table 17.1 two widely used classifications, morphologic and physiologic, are outlined. Used together, these offer a rational pathophysiologic approach to the laboratory diagnosis of anemia.

Table 17.1 Classifications of anemias

I. Morphologic		
N o r m o c y t i c	M i c r o c y t i c	M a c r o c y t i c
normochromic	hypochromic	normochromic

Hematology

Blood loss	Iron deficiency	Megaloblastic anemias
Hemolytic anemia	Sideroblastic anemia	Liver disease
Aplastic anemia	Lead poisoning	Postsplenectomy
Myelophthisic anemia	Thalassemia	Hypothyroidism
Chronic disease, renal insufficiency	Chronic disease	Stress erythropoiesis

II. Physiologic

Hypoproliferation	Excessive destruction or loss of red cell	Maturation abnormality
Aplastic anemia	Hemolytic anemia	Megaloblastic anemias
Myelophthisic anemia	Blood loss	Myelodysplasia, including sideroblastic anemia
Renal insufficiency		Thalassemia
Chronic disease		Iron deficiency
Endocrine deficiency		
Stratus		

17.1. Microcytic anemias

An important mechanism of anemia is defective hemoglobin synthesis, which results in small, poorly hemoglobinized erythrocytes. After Wright staining, instead of red cells with pink hemoglobin filling the cytoplasm, the cells are pale with only a rim of

hemoglobin. Since hemoglobin is made up of two components, either of two pathophysiologic mechanisms can lead to decrease hemoglobin synthesis-defective heme or decreased globin production.

Heme is made up of iron and porphyrins; deficiencies in either affect heme production. Deficiency of iron store, failure to utilize iron properly, and defective heme or porphyrin synthesis are characteristic of iron deficiency anemia, anemia of chronic disease, and the sideroblastic anemias, respectively. In thalassemia syndromes, globin production is decreased, thereby hindering hemoglobin synthesis and producing a microcytic anemia.

17.1.1. Iron deficiency anemia

Iron deficiency is the commonest cause of anemia in every country of the world. It is the most important, but not sole, cause of a microcytic, hypochromic anemia, in which all three red cell indices (the MCV, MCH and MCHC) are reduced and the blood film shows microcytic, hypochromic red cells. This appearance is due to a defect in hemoglobin synthesis.

Nutritional and metabolic aspects of iron

Iron is one of the commonest elements in the earth's crust, yet iron deficiencies the commonest cause of anemia. This is because the body has a limited ability to absorb iron and excess loss of iron due to hemorrhage is frequent.

I. Body iron distribution

Hemoglobin contains about two-thirds of body iron. Iron is incorporated from plasma transferrin into developing erythroblasts in the bone marrow and into reticulocytes. Transferrin obtains iron mainly from reticuloendothelial (RE) cells (macrophages). Only a small proportion of plasma iron comes from dietary iron absorbed through the duodenum and jejunum. At the end of their life, red cells are broken down in the macrophages of the RE system and their iron is subsequently released into the plasma.

Some of the iron is also stored in the RE cells as hemosiderin and ferritin, the amount varying widely according to overall body iron status. Ferritin is a water-soluble protein-iron complex of molecular weight 465,000. It contains up to 20% of its weight as iron and is not visible by light microscopy. Hemosiderin is an

insoluble protein-iron complex of varying composition containing about 37% of iron by weight. It is probably derived from partial lysosomal digestion of aggregates of ferritin molecules and is visible in macrophages by light microscopy after staining by Perls' (Prussian blue) reaction.

Iron in ferritin and hemosiderin is in the ferric form. It is mobilized after reduction to the ferrous form, vitamin C being involved. Iron is also present in muscle as myoglobin and in most cells of the body in iron-containing enzymes, e.g. cytochromes, succinic dehydrogenase, catalase, etc. This tissue iron is less likely to become depleted than hemosiderin, ferritin and hemoglobin in states of iron deficiency, but some reduction of heme-containing enzyme may occur in severe chronic iron deficiency.

II. Dietary iron

Iron is present in food as ferric hydroxides, ferric-protein complexes and heme-protein complexes. Both the iron content and the proportion of iron absorbed differ from food to food; in general, meat and, in particular, liver is a better source than vegetables, eggs or dairy foods. The average Western diet contains 10-15mg of

iron from which only 5-10% is normally absorbed. The proportion can be increased to 20-30% in iron deficiency or pregnancy but, even in these situations, most dietary iron remains unabsorbed.

III. Iron absorption

This occurs through the duodenum and less through the jejunum; it is favored by factors such as acid and reducing agents keeping the iron soluble, particularly maintaining it in the ferrous rather than ferric state.

Excess iron is combined with apoferritin to form ferritin, which is shed into the gut lumen when the mucosal cell reaches the tip of the intestinal villus. In iron deficiency, more iron enters the cell and a greater proportion of this intramucosal iron is transported into portal blood; in iron overload, less iron enters the cell and a greater proportion of this is shed back into the gut lumen.

IV. Iron transport

Most internal iron exchange is concerned with providing iron to the marrow for erythropoiesis. Iron is transported in plasma bound to a β -globulin, transferrin (siderophyllin), of MW 80,000. This protein is synthesized in the liver, has a half-life of 8-10 days, and is capable of binding two atoms of iron per molecule. It

is re-utilized after it has given up its iron. Normally it is one-third saturated but there is a diurnal variation in serum iron, the highest values occurring in the morning and the lowest in the evening. Transferrin gains iron mainly from the macrophages of the RE system and it is the diurnal variation in their release of iron which explains the diurnal variation in serum iron concentration. When plasma iron is raised and transferrin is saturated, the amount of iron transferred to parenchymal cells, e.g. those of the liver, endocrine organs, pancreas and heart, is increased.

V. Iron requirements

The amount of iron required each day to compensate for losses from the body and growth varies with age and sex; it is highest in pregnancy and in adolescent and menstruating females. These groups, therefore, are particularly likely to develop iron deficiency if there is additional iron loss or prolonged reduced intake. Normal adult man iron requirement is 0.5–1.0 mg/day.

Iron deficiency

I. Clinical features

When iron deficiency is developing, the RE stores (hemosiderin and ferritin) become completely depleted

fore anemia occurs. At an early stage, there are usually no clinical abnormalities. Later, the patient may develop the general symptoms and signs of anemia.

II. Causes

Chronic blood loss, especially uterine or from the gastrointestinal tract is the dominant cause. Half a liter of whole blood contains approximately 250mg of iron and, despite the increased absorption of food iron at an early stage of iron deficiency, negative iron balance is usually in chronic blood loss. Increased demands during infancy, adolescence, pregnancy, lactation in menstruating women account for the prevalence of latent iron deficiency (absent iron stores without anemia) and a consequent high risk of anemia in these particular clinical groups.

Newborn infants have a store of iron derived from the breakdown of excess red cells. From 3 to 6 months, there is a tendency for negative iron balance to occur due to growth. Mixed feeding, particularly with iron-fortified foods, prevents iron deficiency. It has been estimated to take 8 years for a normal adult male to develop iron deficiency anemia solely due to a poor diet or malabsorption resulting in no iron intake at all.

Laboratory findings

The laboratory findings are summarized and contrasted with those in other hypochromic anemias in Table 17.2



Table 17.2. Laboratory diagnosis of a hypochromic anemia

	Iron deficiency	Chronic inflammation or malignancy	Thalassemia trait (α or β)	Sideroblastic anemia
MCV	All reduced in relation to severity of anemia	Low normal or mild reduction	All reduced; very low for degree of anemia	Very low in congenital type but MCV often raised in acquired type
MCH				
HCHC				
Serum iron	Reduced	Reduced	Normal	Raised
TIBC	Raised	Reduced	Normal	Normal
Serum ferritin	Reduced	Normal or raised	Normal	Raised
Bone marrow iron stores	Absent	Present	Present	Present
Erythroblast iron	Absent	Absent	Present	Ring forms
Hemoglobin electrophoresis	Normal	Normal	Hb A ₂ raised in β form	Normal

Red cell indices and blood films

- The red cell indices fall and they fall progressively as the anemia becomes more severe.
- The blood film shows hypochromic, microcytic cells with occasional target cells and pencil-shaped poikilocytes.
- The reticulocyte count is low in relation to the degree of anemia.
- When iron deficiency is associated with severe folate or vitamin B₁₂ deficiency a ‘dimorphic’ film occurs

with a dual population of red cells of which one is macrocytic and the other microcytic and hypochromic; the indices may be normal.

- A dimorphic blood film is also seen in patients with iron deficiency anemia who have received recent iron therapy and produced a population of new well-filled normal-sized red cells and when the patient has been transfused.
- The platelet count is often moderately raised in iron deficiency, particularly when hemorrhage is continuing.

Bone marrow iron

- Bone marrow examination is not essential to assess iron stores except in complicated cases, but iron staining is carried out routinely on all bone marrow aspirations that are performed for any reason.
- In iron deficiency anemia there is a complete absence of iron from stores (macrophages) and absence of siderotic iron granules from developing erythroblasts. The erythroblasts are small and have a ragged cytoplasm.

Serum iron and total iron-binding capacity (TIBC)

Hematology

- The serum iron falls and TIBC rises so that the IBC is less than 10% saturated. This contrasts both with the anemia of chronic disorders when the serum iron and the TIBC are both reduced and with other hypochromic anemias where the serum iron is normal or even raised.

Serum ferritin

- A small fraction of body ferritin circulates in the serum, the concentration being related to tissue, particularly RE, iron stores. The normal range in men is higher than in women.
- In iron deficiency anemia, the serum ferritin is very low while a raised serum ferritin indicates iron overload or excess release of ferritin from damaged tissues, e.g. acute hepatitis
- The serum ferritin is normal or raised in the anemia of chronic disorders.

Free erythrocyte protoporphyrin (FEP)

- This increases early in iron deficiency before anemia develops.
- Raised FEP levels are, however, also found in lead poisoning, some cases of sideroblastic anemia and in erythropoietic porphyria.

- The test is not carried out routinely.

17.1.2. Anemia of Chronic disorders

One of the most common anemias occurs in patients with a variety of chronic inflammatory and malignant diseases.

Chronic inflammatory diseases include:

- Infections, e.g. pulmonary abscess, tuberculosis, pneumonia, bacterial endocarditis
- Non-infectious e.g. rheumatoid arthritis, systemic lupus erythematosus (SLE) and other connective tissue diseases

Malignant diseases include:

- Carcinoma, lymphoma, sarcoma

The pathogenesis of this anemia appears to be related to decreased release of iron from macrophages to plasma, reduced red cell lifespan and an inadequate erythropoietin response to anemia. The anemia is only corrected by successful treatment of the underlying disease and does not respond to iron therapy despite the low serum iron.

The characteristic features are:

- Normochromic, normocytic or mildly hypochromic indices and red cell morphology.
- Mild and non-progressive anemia (hemoglobin rarely less than 9.0g/dl)- the severity being related to the severity of the disease.
- Both the serum iron and TIBC are reduced
- The serum ferritin is normal or raised
- Bone marrow storage (RE) iron is normal but erythroblast iron is reduced.

17.1.3. Sideroblastic anemia

This is a refractory anemia with hypochromic cells in the peripheral blood and increased marrow iron; it is defined by the presence of many pathological ring sideroblasts in the bone marrow. These are abnormal erythroblasts containing numerous iron granules arranged in a ring or collar around the nucleus instead of the few randomly distributed iron granules seen when normal erythroblasts are stained for iron.

The anemia is classified into different types:

- **Hereditary** : usually occurs in males, transmitted by females; also occurs rarely in females
- **Acquired**

Hematology

- Primary:
 - Myelodysplasia FAB Type 2
- Secondary:
 - ✓ Other malignant diseases of the marrow, e.g. other types of myelodysplasia, myeloid leukemia, myeloma
 - ✓ Drugs, e.g. antituberculous (isoniazid, cycloserine), alcohol, lead
 - ✓ Other benign conditions, e.g. hemolytic anemia, megaloblastic anemia, malabsorption

There is probably always a defect in heme synthesis. In the hereditary forms, the anemia is characterized by a markedly hypochromic and microcytic blood picture. This is due to a congenital enzyme defect, e.g. of δ -aminolevulinic acid synthetase or heme synthetase. The much more common primary acquired form, is one subtype of myelodysplasia. It is also termed 'refractory anemia with ring sideroblasts'. In the hereditary and primary acquired diseases, 15% or more of marrow erythroblasts are ring sideroblasts. Ring sideroblasts also occur with lesser frequency in the marrow disorders, especially the other types of myelodysplasia, the myeloproliferative diseases, acute myeloid leukemia

and myeloma. They may also occur in the bone marrow of patients taking certain drugs, excess alcohol or with lead poisoning. Vitamin B₆ (pyridoxine) deficiency or vitamin B₆ antagonists (e.g. isoniazid) are rare causes.

17.1.4. Lead poisoning

Lead inhibits both heme and globin synthesis at a number of points. In addition it interferes with the breakdown of RNA by inhibiting the enzyme pyrimidine 5' nucleotidase, causing accumulation of denatured RNA in red cells, the RNA giving an appearance called basophilic stippling on the ordinary (Romanowsky) stain. The anemia may be hypochromic or predominantly hemolytic, and the bone marrow may show ring sideroblasts. Free erythrocyte protoporphyrin is raised.

17.1.5 Thalassemias

These are a heterogeneous group of genetic disorders which result from a reduced rate of synthesis of α or β chains. Clinically they are divided into hydrops fetalis, β -thalassemia major, which is transfusion dependent, thalassemia intermedia characterized by moderate anemia usually with splenomegaly and iron overload, and thalassemia minor, the usually symptomless carrier.

Alpha-thalassemia syndromes

These are usually due to gene deletions. As there is duplication of the α -globin gene, deletion of four genes is needed to completely suppress α chain synthesis. Since the α chain is essential in fetal as well as in adult hemoglobin, deletion of both α genes on both chromosomes leads to failure of fetal hemoglobin synthesis with death in utero (hydrops fetalis). The α -thalassemia traits are usually not associated with anemia, but the MCV and MCH are low and the red cell count is over $5.5 \times 10^{12}/l$. Hemoglobin electrophoresis is normal but occasionally Hb H bodies may be observed in reticulocyte preparations.

Beta-thalassemia syndromes

Anemia in β -thalassemia is a result of (1) decreased synthesis of the β -globin chains of hemoglobin and (2) precipitation and subsequent removal of excess α -globin chains, which in turn lead to ineffective erythropoiesis and hemolysis. Hypochromia, microcytosis, fragmented forms, and basophilic stippling are found in blood from thalassemia patients. Many target cells are also common. The hypochromia is a result of decreased

cellular content of hemoglobin, a major defect in thalassemia. The bone marrow is hyperplastic but the reticulocyte count only moderately increased. The production abnormality is due to ineffective erythropoiesis, that is, destruction of immature erythroid cells in the bone marrow.

17.2 Macrocytic anemia

Macrocytic anemias are divided into those that are associated with megaloblastic changes in the cells of the marrow and peripheral blood and those that are not (Table 17.3). Several forms of macrocytosis are not accompanied by megaloblastic changes and some of these are relatively common. The anemia of liver disease is usually associated with mild to moderate macrocytosis, with MCV often in the range of 100 to 110. The reason for the macrocytosis of liver disease is unclear. It is to be distinguished from the swelling of the red cell membrane that accounts for target cell in some patients with obstructive jaundice. Some authors

Hematology

believe that it is the result of the reticulocytosis that accompanies the hemolytic component of the anemia associated with liver dysfunction.

Similarly, macrocytosis, often in the absence of anemia, is seen in patients who consume large amounts of alcohol, and this is sometimes used as a criterion for the diagnosis of chronic alcoholism. Anemia associated with hypothyroidism can have various morphologic characteristics, but is sometimes macrocytic in nature, for reasons that are not entirely clear. The postsplenectomy state is often associated with mild macrocytosis, in addition to the formation of some target cells and acanthocytes; these changes are due to the fact that young red cells normally undergo a process of surface remodeling, with loss of some of their redundant red cell membrane, with the spleen, and thus splenectomy may be associated with cells containing excessive plasma membrane material. Erythrocytes during the neonatal period are normally macrocytic and are then replaced by cells of normal size.

The macrocytosis that accompanies “stress” erythropoiesis deserves some attention. In the presence of high serum levels of erythropoietin

stimulated by anemia and the attendant hypoxemia, there is early release of immature red blood cells from the bone marrow, that is, a “shift” of immature bone marrow reticulocytes into the peripheral blood. These immature cells are larger than normal and they are also usually polychromatophilic (gray in color) because they still contain relatively large amounts of RNA (which is blue in stained blood films) and have not yet completed the process of hemoglobin synthesis (they are not yet fully “pinked up”). Thus, the MCV is typically moderately elevated with the reticulocytosis and polychromatophilia that accompany the erythyroid hyperplasia of the bone marrow in response to hemolysis or bleeding.

Macrocytosis of mild degree is often seen as well in conditions in which the anemia is due to a decrease in erythropoietic tissue in the bone marrow, for example, aplastic anemia, pure red cell aplasia, or the bone marrow suppression caused by chemotherapy. In these situations there is also a high titer of erythropoietin in the plasma, and this causes a rapid rate of ingress of young red blood cells into the peripheral blood. Major causes of macrocytic anemia that are megaloblastic in nature are vitamin B₁₂ or folic acid deficiency, both of which have multiple causes.



Table 17.3 Causes of macrocytosis

Nonmegaloblastic

Liver disease, alcoholism

Hypothyroidism

Postsplenectomy

Neonatal macrocytosis

“stress” erythropoiesis (with expanded or compromised erythropoiesis in the marrow)

Megaloblastic

Vitamin B₁₂ deficiency (multiple causes)

Folic acid deficiency (multiple causes)

Other causes (antineoplastic drugs, metabolic disorders, neoplastic erythropoiesis)

17.2.1 Megaloblastic anemia

The basic underlying defect in megaloblastic anemia is defective DNA synthesis and cell division. This result in ineffective erythropoiesis, that is, death of immature erythyroid cells before release from the bone marrow, associated with some early destruction of circulating erythrocytes as well. It is not entirely clear, however, how the deficiency in vitamin B₁₂ or folic acid leads to defective DNA synthesis or how defective DNA synthesis results in premature cell death. It is known that a state of unbalanced growth exists in the marrow

cells of patients with megaloblastic anemia.

The megaloblasts contain a substantially increased amount of RNA and a normal or slightly increase amount of DNA. This imbalance comes about because there is a delay in cell division due to impaired synthesis of one or more deoxyribonucleotides, the precursors of DNA, while RNA production proceeds normally. It is possible that premature cell death results form this unbalanced cell maturation. Presumably the degree of impairment of DNA synthesis varies form cell to cell and is more prominent among erythyroid cells than among granulocyte and platelet precursors. Although most anemias characterized by megaloblastic erythropoiesis are due to either vitamin B₁₂ or folic acid deficiency, there are several other causes of megaloblastic hematopoiesis. Some of these diseases are inherited, others are iatrogenic (drug-induced; e.g. 6-mercaptopurine, cytosine arabinoside, methotrexate), and some may be neoplastic. All fail to respond to replacement therapy with vitamin B₁₂ or folic acid.

Laboratory findings

- Pancytopenia :
As a result of ineffective erythropoiesis,

granulopoiesis, and thrombopoiesis, and premature destruction of defective cells in the peripheral blood, it is unusual to find a patient with megaloblastic anemia who does not have depression of all three cell lines in the peripheral blood.

- Bone marrow is hyperplastic
Despite this pancytopenia, the bone marrow is hyperplastic-reflecting the fact that ineffective production of blood cells with early death in the marrow is the major pathophysiologic mechanism in megaloblastic anemia.
- The megaloblastic bone marrow produces macrocytic, oval red cells.
- Their MCH and MCV are both increased, and the MCHC is normal.
- Macroovalocytosis, as seen in the peripheral blood smear, is a hallmark of megaloblastic anemias.
- The reticulocyte count is usually less than 1 percent. Occasionally it is 2 to 3 percent, but the reticulocyte production index is low, a reflection of a functionally defective marrow.
- Poikilocytosis:
Marked abnormalities in the shape of red cells also occur in megaloblastic anemias. It has been suggested that these abnormalities result from

fragmentation of the abnormal large red cells as they pass through small arterioles. As the megaloblastic anemia becomes more severe, bizarre shapes such as triangles and helmets increases proportionately.

- Hypersegmented polys
The megaloblastic process also leads to abnormalities in white cells. Cells size and average number of lobes in the mature granulocyte (poly) are increased. Normally no more than 1 percent of polys have six nuclear lobes, but in megaloblastic anemia many have six or more, even ten, lobes. The hyperlobulation is presumably due to abnormal nuclear development.
- Elevated levels of serum lactic acid dehydrogenase (LDH), bilirubin, and fecal and urinary urobilinogen are due to ineffective erythropoiesis.
- Plasma iron turnover and marrow iron uptake are both increased despite decreased incorporation of iron into mature red cells.
- Hemolysis or premature death of mature erythrocytes in the peripheral blood. Despite hemolysis the reticulocyte production index is reduced because of the ineffective erythropoiesis in the bone marrow.

- Megaloblastic erythropoiesis and giant myeloid forms in the bone marrow. Morphologically, the megaloblastic erythropoiesis is characterized by the presence of large cells, with asynchronism between nuclear and cytoplasmic development. This morphologic appearance—an immature nucleus associated with mature cytoplasm—parallels the biochemical abnormality whereby DNA synthesis and maturation of the cell nucleus are impaired while cytoplasmic RNA and hemoglobin synthesis proceed normally.
- Giant white cell precursor forms, abnormal megakaryocytes, and hypercellularity of all three cell lines are also features of megaloblastic marrows.

Vitamin B₁₂

Since vitamin B₁₂ is common in human diets, almost all deficiencies of vitamin B₁₂ are a result of malabsorption. Vitamin B₁₂ is made up of a porphyrin like structure attached to a nucleotide. This structure is analogous to the porphyrin structure of heme, with position of the heme iron being occupied by a cobalt atom. The ultimate source of vitamin B₁₂ in man is from microbial synthesis. The vitamin B₁₂ synthesized by microbes is deposited in animal tissues, such as liver, eggs, and

Hematology

milk, and is therefore plentiful in fish and meat products.

A normal diet contains a large excess of vitamin B₁₂ compared with daily needs (Table 17.4). The average diet contains 5 to 30 μ g of vitamin B₁₂ daily, 1 to 2 μ g of which usually is absorbed and retained. In the adult a storage pool of 3000 to 5000 μ g is present, of which 1000 to 3000 μ g is stored in the liver. If malabsorption of vitamin B₁₂ occurs, it will take 2 to 5 years before body stores are exhausted and megaloblastic erythropoiesis supervenes. Vitamin B₁₂ binds with a glycoprotein called intrinsic factor (IF), which is secreted by the parietal cell located in the body of the stomach for absorption. The intrinsic factor-B₁₂ complex is absorbed in the distal ileum. The most common disease associated with vitamin B₁₂ malabsorption, pernicious anemia, is caused by failure to secrete adequate amount of IF. Three to four hours after oral ingestion, vitamin B₁₂ is detected in the blood. A peak level is obtained in 8 to 10 hours. The vitamin is attached to three protein binders named transcobalamin (TC) I, TC II, and TC III for transportation.

Hematology

Table 17.4 Vitamin B₁₂ and folate; nutritional aspects

	Vitamin B ₁₂	Folate
Normal daily dietary intake	5 – 30µg	200-250µg
Main foods	Animal produce only	Most, especially liver, greens and yeast
Cooking	Little effect	Easily destroyed
Minimal adult daily requirement	1 - 2µg	150µg
Body stores	3 – 5mg (sufficient for 2-5 years)	5 - 20mg (sufficient for 3-6 months)
Absorption site	Ileum	Duodenum and jejunum
Mechanism	Intrinsic factor	Conversion to methyltetrahydrofolate
Limit	2-3µg daily	50-80% of dietary content
Enterohepatic circulation	5-10µg/day	90µg/day
Transport in plasma	Bound to TC	Weakly bound to albumin

Schilling test

One of the most useful means of making the diagnosis of vitamin B₁₂ deficiency and determining its etiology is the Schilling test, which measures the absorption of orally administered radiolabeled vitamin B₁₂.

The simplest and most commonly employed method is to give the patient a 0.5 or 1µg dose of radiocobalt-

labeled cyanocobalamin and either immediately or 2 hours later to administer a 1mg dose of nonradioactive cyanocobalamin intramuscularly. This “flushing” dose is used to saturate vitamin B₁₂ binding sites in the plasma and liver. A 24 hour collection of urine is begun after the radioactive B₁₂ has been ingested. Normal subjects will excrete in their urine 7 percent or more of the radioactivity taken orally, whereas patients with pernicious anemia or other causes of vitamin B₁₂ malabsorption will excrete well less than 7 percent. Renal insufficiency or incomplete collection of urine may result in a spuriously low excretion rate.

The second part of the Schilling test is performed only if the first part gives abnormal results. In the second part 60mg of hog IF is given orally along with the radioactive vitamin B₁₂. If there is a defect in the absorption of the vitamin B₁₂-IF complex, then abnormally small amounts of B₁₂ will be excreted. However, if the patient's gastric secretions lack IF, the addition of hog IF to the vitamin B₁₂ oral dose leads to normal urinary excretion of the vitamin B₁₂. Thus, the part one and part two Schilling tests distinguish IF deficiency from ileal malabsorption of IF-B₁₂ complex.

A third part of the Schilling test may be performed to determine if the patient suffers from malabsorption of the IF-B₁₂ complex secondary to small-intestine bacterial overgrowth. In part three of the Schilling test a 2-week course of antibiotic therapy with tetracycline, 250mg four times per day, is prescribed. If bacterial overgrowth was responsible for the abnormal second part of the Schilling test, then tetracycline treatment should normalize vitamin B₁₂ absorption. In practice, the third part of the Schilling test is seldom performed.

Vitamin B₁₂ deficiency

The deficiency is usually due to pernicious anemia (Table 17.5). Much less commonly the deficiency may be caused by veganism in which the diet lacks B₁₂ (usually in Hindu Indians), gastrectomy or small intestinal lesions. There is no syndrome of B₁₂ deficiency due to increased utilization or loss of the vitamin, so the deficiency inevitably takes at least 2 years to develop, i.e. the time needed for body stores to deplete at the rate of 1-2 μ g each day when there is no new B₁₂ entering the body from the diet.

Table 17.5 Causes of vitamin B₁₂ deficiency

Decreased intake

Strict vegetarianism

Decreased absorption

Pernicious anemia

Congenital lack of IF production

Selective vitamin B₁₂ malabsorption

Total or partial gastrectomy

Chronic pancreatitis

Regional ileitis, particularly with ileal resection

Ileal resection

Sprue

Competition

Fish tapeworm

Blind loop syndromes

Small-intestinal diverticulosis

Pernicious anemia (PA)

Pernicious anemia is the disease most often associated with vitamin B₁₂ deficiency. It is defined as anemia resulting from defective secretion of IF by the gastric mucosal cells associated with chronic atrophic gastritis. The diagnosis of PA is confirmed by a low serum B₁₂ level and typically abnormal results of the Schilling test. More females than males are affected (1.6:1).

Hematology

Characteristically patients with PA are of Northern European extraction and have fair complexions and blue eyes. Long earlobes, prematurely gray hair, and blood group A are other clinical features that have been associated with PA. The patients are usually elderly, but can be of any age. Not all patients fit this description, and many patients who have these clinical findings do not suffer from PA.

Folic acid

The terms folic acid and folate refer to a large group of compounds consisting of three moieties, pteridine, para-aminobenzoic acid, and a variable number of glutamic acid units. Foliates are widely distributed in a variety of food, including green vegetables, liver, kidney, and dairy products (Table 17.4). A daily diet contains fifty to several hundred micrograms of folates. Cooking, particularly boiling, destroys this thermolabile vitamin. During the process of intestinal absorption the folates are converted to 5-methyltetrahydrofolate, which is the main transport and storage form of folate in man.

About 50 μ g of folic acid is required daily from food. Normally 5 to 20mg of folic acid is stored in the liver and other tissues. For this reason it takes 3 to 6 months for

Hematology

tissue stores to be completely exhausted in the absence of folate replacement. Folate deficiency is most often due to a poor dietary intake of folate alone or in combination with a condition of increased folate utilization or malabsorption (Table 17.6). Excess cell turnover of any sort, including pregnancy, is the main cause of an increased need for folate.



Table 17.6 Causes of folate deficiency

Decreased intake

Poor diet or overcooking of folate-containing foods

Alcoholism (also impairs folate metabolism)

Decreased absorption

Sprue and other malabsorption syndromes

Anticonvulsant and oral contraceptive drugs

Increased requirement

Pregnancy

Erythroid hyperplasia of the marrow (hemolysis, thalassemia)

Leukemias and other neoplastic disorders

Skin disease such as psoriasis, exfoliative dermatitis

Other causes

Chemotherapy with folic acid antagonists

Renal dialysis

Vitamin C deficiency

17.3. Normocytic anemias

17.3.1. Aplastic Anemia

Aplastic (hypoplastic) anemia is defined as pancytopenia (anemia, leucopenia, and thrombocytopenia) resulting from aplasia of the bone marrow. A selective decrease in red cell production is referred to as pure red cell aplasia. Patients with aplastic anemia generally have symptoms characteristic of a particular cellular deficiency. Those with anemia may be fatigued or short of breath, those with neutropenia may manifest serious infection, and those with thrombocytopenia may demonstrate petechiae or bleeding. The diagnosis is suggested by the presence of pancytopenia. A low reticulocyte count suggests underproduction rather than increased loss or destruction of red cells. The diagnosis is confirmed with a bone marrow biopsy that shows a substantial decrease in the number of red cell, white cell, and platelet precursors, and replacement of the usually cellular bone marrow with fat.

Aplastic anemia can be mild or severe, and the

management of the patient depends on the severity of the illness. Failure of the pluripotential stem cells of the bone marrow to maintain bone marrow cellularity and the production of normal numbers of mature red cells, neutrophils, and platelets characterizes aplastic anemia. Failure of the pluripotential stem cell can be caused by many different factors (Table 17.7). In most cases of aplastic anemia, the cause is not known. These cases are referred to as idiopathic. Many agents that cause aplastic anemia, such as benzene and radiation, can on occasion precipitate malignant transformation of the damaged bone marrow stem cells, resulting in the development of acute leukemia.

Table 17.7 Etiologies of aplastic anemia

-
- Idiopathic
 - Radiation
 - Drugs
 - Antimicrobials – chloramphenicol
 - Antiepileptics – carbamazepine, diphenylhydantoin
 - Anti-inflammatory – phenylbutazone
 - Antithyroid – methimazole (Tapazole)
 - Gold compounds
 - Organic arsenicals
 - Chemotherapeutic agents – alkylating agents
 - Toxins
 - Solvents – benzene
 - Insecticides – DDT
 - Viral agents
 - Hepatitis B virus
 - Non-A, non-B hepatitis virus
 - Epstein-Barr virus
-

Laboratory findings

- Pancytopenia.
- Anemia is normochromic, normocytic or macrocytic.
- Reticulocyte count is low.
- There are no abnormal cells in the peripheral blood.
- Bone marrow shows hypoplasia, with loss of hemopoietic tissue and replacement by fat.

Normally, 50 percent of the bone marrow is fat on histologic examination of the bone marrow biopsy, but in aplastic anemia of ten 80 to 95 percent is fat.

- Serum iron, vitamin B₁₂, and folic acid levels are normal or, in the case of iron, often high because of underutilization.

Pure Red cell Aplasia

Acquired pure red cell aplasia is a rare disorder, usually immunologically mediated, in which there is a specific failure of production of red cells. The patient has a normal white blood cell count and normal platelet count. There is severe anemia and a low reticulocyte count. The bone marrow biopsy shows a selective absence of red blood cell precursors, whereas white cell and platelet precursors are present in normal numbers.

Anemia of Renal Failure

Patients with significant renal disease almost always have anemia. Patients who require dialysis are almost always severely anemic and need repeated transfusions. The primary cause of the anemia is a lack of erythropoietin, a hormone necessary for red cell growth and development in the bone marrow. Erythropoietin is made in the kidney.

Anemia of Chronic Disease

In cases of chronic systemic inflammation, infection, or malignancy, the anemia of chronic disease (ACD) will often occur. This is frequently a mild to moderate anemia with hematocrits between 29 and 35%. The anemia is usually normocytic and normochromic with a normal reticulocyte percentage. About 40 percent of the time, the anemia is microcytic and hypochromic, usually only mildly so, but occasionally sufficient to cause confusion with iron deficiency anemia. In ACD the serum iron level is low, but so is the TIBC, in contrast to iron deficiency, in which the serum iron is low but the TIBC is usually elevated. The serum ferritin is normal or often elevated in ACD because it is an acute-phase reactant; it is characteristically low in iron deficiency.

Inspection of the bone marrow usually shows abundant iron in reticuloendothelial cells, but little or no iron in red cell precursors. Thus, the patient has adequate iron stores, but is unable to transfer iron from the reticuloendothelial system storage cells to the red cell precursors that need it to form hemoglobin. The cause of this block in iron reutilization is uncertain, and there is no effective treatment other than to correct the

underlying chronic disease.

Myelophthistic anemia

Neoplasms, granulomatous infections, or a fibrotic process can directly replace the bone marrow. This may lead to a “myelophthistic” blood picture in which early white cell precursors as well as nucleated red cells are found in the peripheral blood, as are giant platelet forms or megakaryocyte fragments. Mature red cells often display a teardrop appearance. Infectious disease that may invade the bone marrow include tuberculosis and other mycobacterial infections (including atypical mycobacterial infections in patients with AIDS).

Anemias Associated with Endocrine Abnormalities

[Hypothyroidism, Hypopituitarism]

A mild anemia is commonly associated with hypothyroidism. This is usually normochromic and normocytic but may be macrocytic. The reticulocyte count is low, demonstrating that this is a hypoproliferative anemia, through the actual mechanism is not known.

A mild normochromic, normocytic anemia is associated with hypopituitarism. The mechanism is unclear.

Patients with Addison's disease also have a mild normochromic, normocytic anemia.

17.3.2 Hemolytic anemia

Hemolytic anemias are defined as those anemias which result from an increase in the rate of red cell destruction. In hemolytic disorders, red cells are destroyed prematurely, usually in a random fashion. If the red blood cell life span is only moderately shortened, the patient will usually have little, if any, anemia because the bone marrow is capable of increasing the rate of new red blood cell production by a factor of 4 to 8.

Normal red cell destruction

Red cell destruction usually occurs after a mean lifespan of 120 days when the cells are removed extravascularly by the macrophages of the reticuloendothelial (RE) system, especially in the marrow but also in the liver and spleen. Red cell metabolism gradually deteriorates as enzymes are degraded and not replaced, until the cells become non-viable, but the exact reason why the red cells die is obscure. The breakdown of red cells liberates iron for recirculation via plasma transferrin to marrow erythroblasts, and protoporphyrin which is broken down to bilirubin. This circulates to the liver

where it is conjugated to glucuronides which are excreted into the gut via bile and converted to stercobilinogen and stercobilin (excreted in feces). Stercobilinogen and stercobilin are partly reabsorbed and excreted in urine as urobilinogen and urobilin.

A small fraction of protoporphyrin is converted to carbon monoxide (CO) and excreted via the lungs. Globin chains are broken down to amino acids which are reutilized for general protein synthesis in the body. Haptoglobins are proteins present in normal plasma capable of binding hemoglobin. The hemoglobin-haptoglobin complex is removed from plasma by the RE system. Intravascular hemolysis (breakdown of red cells within blood vessels) plays little or no part in normal red cell destruction.

Extravascular Versus intravascular hemolysis

There are two general sites in which hemolysis may take place (Table 17.8). In intravascular hemolysis, which is uncommon, red blood cells are destroyed directly within the circulatory system. Extravascular hemolysis is more common than intravascular hemolysis and involves the destruction of red blood cells within mononuclear-phagocytic cells, often in the spleen.

Table 17.8 Hemolytic anemia

Site of hemolysis	
Extravascular	Intravascular
Mechanism of hemolysis	
Extracorporeal	Intracorporeal
<ul style="list-style-type: none"> • Extrinsic to RBC • Usually acquired • Morphologic stigmata may or may not be present on blood smear 	<ul style="list-style-type: none"> • Intrinsic to RBC • Usually inherited • Morphologic stigmata usually present on smear

Intracorporeal versus Extracorporeal Defects

Intracorporeal defects are intrinsic to the red blood cell (Table 17.9). They are usually inherited, and generally (but not always) the abnormality is observable in the peripheral blood smear. Extracorporeal defects refer to problems in the environment of the red blood cell, not in the red blood cell itself (Table 17.10). Extracorporeal hemolysis is usually acquired and is often but not always discernible in the form of morphologic abnormalities in the peripheral blood smear.

Table 17.9 Intracorpuseular hemolytic anemias

Membrane defects

Congenital spherocytosis

Congenital elliptocytosis

Paroxysmal nocturnal hemoglobinuria*

Metabolic defects

Pentose shunt defects

Embden-Meyerhof pathway defects

Hemoglobin defects

Hemoglobinopathies (S,C unstable hemoglobin, etc)

*Acquired defect

Table 17.10 Extracorpuseular hemolytic anemias

Immune disorders

ABO incompatibility (transfusion reaction)*

Rh incompatibility (erythroblastosis fetalis)

Autoimmune or immunohemolytic anemias

Warm Cold antibodies

IgG Complement Coombs' test

Paroxysmal cold hemoglobinuria (Donath-

Landsteiner antibody)*

Physical damage

Micro-or macroangiopathic hemolytic anemias*

Burns*

Chemicals, toxins, drugs

H₂O*, *Clostridium welchii* toxin*, spur cell anemia, oxidant drugs*, drugs causing immunohemolytic anemia

Increased activity of reticuloendothelial system

Hypersplenism

Infections

Malaria*

Infectious mononucleosis

Mycoplasma pneumoniae

Cl. Welchii

*Intravascular hemolysis

Laboratory findings

- The major criteria for the laboratory diagnosis of hemolytic anemia are reticulocytosis and an increase in serum level of unconjugated bilirubin.
- Serum level of lactic dehydrogenase (LDH) is elevated.
- Serum haptoglobin level is decreased.
- The peripheral blood smear often but not invariably shows morphologic changes in the red blood cells compatible with hemolysis. For example, many spherocytes suggest hereditary spherocytosis or immunohemolytic anemia and sickle cells suggest one of the sick cell syndromes.

INHERITED HEMOLYTIC ANEMIA

Hematology

This is a congenital hemolytic anemia, some of which present at birth, and others later in life, while still others may remain silent unless a physiologic stress is superimposed.

Hereditary spherocytosis

Hereditary spherocytosis (HS) is an autosomal dominant disorder that may become symptomatic shortly after birth, or may not be detected until later life. Most patients with HS have spherocytes, splenomegaly, and jaundice.

Laboratory findings

- Patients with HS have laboratory evidence of hemolysis, including anemia, reticulocytosis, increased serum LDH level, decreased or absent haptoglobin, and often mild hyperbilirubinemia.
- Except during hemolytic crises they do not have hemoglobinemia or hemoglobinuria.
- Examination of the peripheral blood smear shows large numbers of spherocytes, often accompanied by polychromatophils.
- The spherocytes are more susceptible to osmotic stress as measured by the osmotic fragility test.

Hematology

- The MCV may be low normal or, with reticulocytosis, moderately elevated
- The MCHC is characteristically high. HS is one of the few causes of an elevated MCHC.

Hereditary elliptocytosis

Hereditary elliptocytosis (HE) is an autosomal dominant disorder characterized by excessive numbers of elliptical cells. HE cells are biconcave dumbbells with an axial ratio of less than 0.8. In the majority of cases hematocrit levels are normal or near normal with minimal hemolysis; greater than 25 percent (often 75%) of red cells are elliptocytes. In 10 to 15 percent of patients with HE, erythrocyte destruction is substantially increased, leading to all the signs and symptoms of a true hemolytic anemia. It should be noted that some elliptical cells also occur in thalassemia, iron deficiency, myelophthistic anemias, sickle cell disease, and megaloblastic anemia. These disorders, however, are accompanied by other characteristic morphologic changes as well.

Erythrocyte enzyme deficiencies

Hereditary hemolytic anemia has been associated with

Hematology

at least ten red cell enzyme deficiencies. Of these, only three are of clinical significance.



I. Glucose-6-phosphate Dehydrogenase deficiency

Deficiency of the enzyme glucose-6-phosphate dehydrogenase (G-6-PD) is by far the most common inherited erythrocyte enzyme deficiency, affecting more than 100 million people. The gene for G-6-P is sex-linked. Because of the X-linkage, male patients are more severely affected than female patients. It is a key enzyme in the hexose monophosphate pathway (HMP).

II. Pyruvate Kinase Deficiency

Pyruvate kinase (PK) deficiency is much less common than G-6-PD deficiency. However, it is the second most common erythrocyte enzyme deficiency. The deficiency is not limited to any particular racial or geographically defined population. Rather than producing acute hemolysis in association with drug ingestion, it causes a chronic congenital nonspherocytic hemolytic anemia.

III. Pyrimidine-5'-nucleotidase deficiency

A chronic hemolytic anemia inherited as an autosomal recessive and characterized by large numbers of erythrocytes with basophilic stippling is due to deficiency in an enzyme, Pyrimidine-5'-nucleotidase, which dephosphorylates the ribonucleotides of cytidine and uridine.

Hemoglobinopathies

Mutations in the DNA sequence controlling the synthesis of globin chains in hemoglobin result in either structurally abnormal hemoglobins or reduced globin chain synthesis or, sometimes, both. Generally the term hemoglobinopathy is used to signify a structurally abnormal hemoglobin with at least one amino acid substitution. Thalassemia refers to DNA mutations resulting in normally structural globins but with reduced or negligible synthesis rates.

Structural abnormalities may cause premature red cell destruction; easily denatured hemoglobins; hemoglobins with abnormal oxygen affinity; altered hemoglobin solubility; and, in a few instances, reduced globin synthesis. The heme moiety of hemoglobin is synthesized normally and is structurally normal. In this topic only the few clinically significant hemoglobinopathies are discussed.

I. Hemoglobin S

By far the most important hemoglobinopathies are those related to the presence of sickle hemoglobin (HbS). This hemoglobin is present in approximately 10 percent of blacks. Sickle hemoglobin results from replacement

of the sixth amino acid from the N-terminal end of the β -chain, glutamic acid, by valine. Invariably sickle cells are typically seen on Wright-stained peripheral blood smears from patients.

II. Hemoglobin C syndromes

Hemoglobin C (HbC) is probably the second most common hemoglobinopathy (2-3% gene frequency in black populations). HbC is caused by substitution of lysine for glutamic acid in the sixth position from the N-terminal end of the β -hemoglobin chain (same location as the substitution in HbS). The peripheral blood smear shows increased numbers of target cells.

ACQUIRED HEMOLYTIC ANEMIA

This includes immuno hemolytic Anemias, PNH, fragmentation hemolysis, hypersplenism, chemicals and toxins. A variety of acquired clinical conditions result in shortened survival of previously normal red cells. These include immune-mediated destruction, red cell fragmentation disorders, acquired membrane defects, splenic effects, and the results of infections and environmental toxins.

Immuno-hemolytic anemia

Immuno-hemolytic anemias are the result of the binding of antibody, complement, or antibody plus complement to red cells. Antibodies formed against erythrocyte antigens may be either warm (active at 37°C) or cold (active at room temperature and below). In some cases, these antibodies activate a series of proteins, referred to collectively as complement; in others, the red cells are coated with antibody alone.

As a result of complement activation by hemolytic antibodies, intravascular red cell lysis and release of hemoglobin may occur. Alternatively, and more frequently, immune lysis, due to either antibody or complement, is extravascular and happens slowly within cells of the macrophagic-phagocytic system (RES), particularly in the spleen.

Immuno-hemolytic anemias fall into one of three major categories: autoimmune, in which the patient makes an autoantibody against his or her own red cells; alloimmune, where the patient's antibody is directed against foreign red cells; and drug-induced, where a drug-dependent or related antibody is responsible for hemolysis (Table 17.11).

Table 17.11 Classification of immunohemolytic anemias

Autoimmune hemolytic anemia

- Warm autoimmune hemolytic anemia
- Cold agglutinin syndrome
- Paroxysmal cold hemoglobinuria

Drug induced hemolytic anemias

Alloimmune hemolytic anemia

- Transfusion reactions
 - Hemolytic anemia of the newborn
-

I. Autoimmune hemolytic anemia (AIHA)

A. Warm AIHA

This illness, more common than the two other autoimmune hemolytic anemias, occurs in 1 to 3 individuals per 100000 in the population. The red cells are usually coated with IgG alone, IgG and complement or complement alone, but a minority of cases show IgA or IgM coating alone or combined with IgG antibody. The complement component detectable is C3d, the degraded fragment of C3. The AIHA in SLE is typically of the IgG + complement type. Red cells coated with IgG are taken up the RE macrophages, especially in the spleen, which have receptors for the Fc fragment.

Part of the coated membrane is lost so the cell becomes

progressively more spherical to maintain the same volume and is ultimately prematurely destroyed, usually predominantly in the spleen. Red cells with complement coating alone or in addition to IgG are destroyed more generally in the RE system, and not particularly in the spleen. The disease may occur at any age in either sex and presents as a hemolytic anemia of varying severity.

Laboratory findings

The hematological and biochemical findings are typical of a hemolytic anemia with spherocytosis prominent in the peripheral blood. The hallmark of autoimmune hemolytic anemia is the presence of antibody or complement, or both, on the patient's own red cells. The DAT is positive due to IgG, IgG and complement, IGA or, rarely, IgM on the cells. In some cases, the autoantibody shows specificity within the rhesus system, e.g. anti-c or anti-e. The antibodies both on the cell surface and free in serum are best detected at 37°C.

B. Cold AIHA

This hemolytic anemia is less common than its warm counterpart. In these syndromes the autoantibody, whether monoclonal (as in the idiopathic cold hemeagglutinin syndrome or associated with

lymphoproliferative disorders) or polyclonal (as following infection, e.g. infectious mononucleosis or *Mycoplasma pneumonia*) attaches to red cells mainly in the peripheral circulation where the blood temperature is cooled.

The antibody is usually IgM and binds to red cells best at 4°C. Hemolytic syndromes of varying severity may occur depending on the titer of the antibody in the serum, its affinity for red cells, its ability to bind complement, and its thermal amplitude (whether or not it binds to red cells at 37°C). Agglutination of red cells by the antibody often causes peripheral circulation abnormalities. The antibody may then detach from red cells when they pass to the warmer central circulation but, if complement has been bound, the direct antiglobulin test remains positive-of complement only type- and the cells are liable to be destroyed in the whole RE system, especially the liver, giving rise to a chronic hemolytic anemia. Intravascular hemolysis occurs in some of the syndromes, in which the complement sequence is completed on the red cell surface. Low serum levels of complement in other case may help to protect the patient from a more severe clinical disease.

C. Paroxysmal cold hemoglobinuria

This rare disease, characterized by hemoglobinuria following cold exposure, is caused by an IgG autoantibody to the red cell antigen P. This Donath-Landsteiner autoantibody is unique in that it binds to red cells at cold temperatures, in contrast to other IgG antibodies. Furthermore, it binds complement well, and brisk hemolysis results when the cells are warmed and the complement sequence proceeds to completion. Viral infections and syphilis are predisposing causes.

Laboratory findings

These are similar to those of warm AIHA, except that spherocytosis is less marked, red cells agglutinate in the cold. E.g. on the blood film made at room temperature, and the DAT reveals complement (C₃) only on the red cell surface. Serum antibodies often present in high titer are IgM, react best at 4°C. In the rare cold AIHA, paroxysmal cold hemoglobinuria, the antibodies are IgG and have specificity for the P blood group antigens.

II. Drug induced immune hemolytic anemias

Four pathophysiologic mechanisms account for most cases of drug-induced red cell sensitization and positive

direct Coombs test. The drug-induced problem may result in serious hemolytic anemia on the one hand, or a laboratory abnormality without clinical sequelae on the other.

A. Penicillin: ‘Hapten’ (drug adsorption) mechanism

Penicillin binds strongly to the red cell membrane, and can be detected on red cells in many patients who are receiving high doses of this drug. Although the drug coating by itself is not harmful, some patients develop high-titer antipenicillin IgG antibodies, which can react with the coated red cells. The coombs test is positive due to the presence of IgG; complement is not usually found.

B. Quinidine: ‘Innocent bystander’ (immune complex) mechanism

In some patients previously sensitized to quinidine, and taking it again, the drug reacts with a quinidine antibody, often IgM, to form an immune complex. This complex is then adsorbed onto the red cell membrane; the red cell is considered an “innocent bystander” because it is not the direct target of the antibody. The immune complexes often activate complement, and an abrupt and life-threatening intravascular hemolytic anemia may

develop. The coombs test is positive for complement; the immune complexes themselves do not bind firmly to the cell.

C. α -methyldopa (Aldomet): Autoimmune hemolysis by unknown mechanism

In as many as one third of patients taking 2gm α -methyldopa daily, a positive direct Coombs test develops after 3 to 6 months of use. Far fewer (between 1 and 5%) develop frank hemolysis. The drug itself does not attach to red cells or antibodies, but somehow causes the development of red cell IgG autoantibodies, which closely resemble those found in warm AIHA. The direct Coombs test is usually strongly positive with IgG; complement is rarely found.

D. Cephalosporins: Membrane modification

These drugs cause a positive direct Coombs test through a non-immunologic mechanism. Cephalothin and other cephalosporins are capable of altering the red cell membrane so that proteins, including complement and an assortment of γ -globulins, are nonspecifically adsorbed. As a result of the presence of these proteins, the direct antiglobulin test is positive. However, the red cell eluate does not react with any other cells, because

the mixture of γ -globulins does not include any predominantly red cell antigen-specific antibody. The antibody screen is negative because no unusually drug-related antibodies are present. Hemolytic anemia does not occur in this situation.

III. Alloimmune hemolytic anemias

A. Hemolytic transfusion reactions

The differential diagnosis of a positive direct antiglobulin test includes not just red cell autoantibodies but also alloantibodies-antibodies in the patient directed against foreign red cell antigens. These antibodies are either “naturally occurring,” in that individuals acquire them without specific exposure to the red cell antigen, or “immune,” from red cell transfusions.

Acute hemolytic transfusion reactions

ABO antibodies are the most important example of naturally occurring red cell antibodies (so-called isoantibodies) that can cause severe, even fatal, hemolysis. For example, a patient whose red cells are group O has anti-A and anti-B in his or her serum. Like many other IgM antibodies, these isoagglutinins are potent complement fixers. If inadvertently transfused with group A red cells, this patient's anti-A would

immediately react with the donor cells. Complement fixation and intravascular hemolysis would result.

The direct Coombs test is positive due complement fixation, but may become negative within hours to days, depending on how rapidly the group a cells are destroyed. The presence of urine hemosiderin beginning 3 to 5 days after the transfusion attests to the recent presence of hemoglobinemia.

Delayed hemolytic transfusion reactions

In some patients, the titer of non-ABO antibodies after transfusion wanes, and the antibody becomes undetectable. If the patient then receives an antigen-positive unit, an anamnestic rise in antibody occurs over the next 3 to 21 days. This results in delayed hemolysis. Here, red cell destruction is usually leisurely, since the cells are eliminated only after they are coated with sufficient antibody, which depends on the rapidity with which it is produced. The direct Coombs test on a posttransfusion blood specimen is positive due to IgG-coated transfused red cells. The test becomes negative as the antibody-coated cells are removed from the circulation. The patient's antibody screen, negative before the transfusion, becomes positive shortly

afterward.

B. Hemolytic disease of the newborn

This hemolytic process actually begins in utero to the baby of a mother with IgG red cell antibodies. IgG antibodies readily cross the placenta, as opposed to IgM antibodies, which cannot. In the past, many Rh(D)-negative women became sensitized to the red cell antigen D at the time of birth of a first Rh-positive child, because at birth it is common for a small volume of fetal cells to enter the maternal circulation. Today, Rh sensitization is much less common and largely preventable. Rh-positive fetuses carried by a sensitized Rh-negative mother can be severely affected by the IgG anti-D. Some babies develop profound in utero anemia with congestive heart failure (hydrops fetalis), leading to stillbirth.

Paroxysmal nocturnal hemoglobinuria

Paroxysmal nocturnal hemoglobinuria (PNH) is a rare, acquired membrane disorder that results in red cells becoming unusually sensitive to the hemolytic action of complement. The susceptible red cells are clonally derived, meaning that all abnormal cells have descended from a single pluripotential stem cell with the PNH mutation.

Laboratory findings

Patients with PNH often have severe anemia, but in contrast to other acquired hemolytic anemias, no spherocytes or other morphologic abnormalities are seen on examination of the peripheral blood smear. The reticulocyte count is high. Over time, some patients develop hypochromic microcytic red cells due to progressive iron deficiency, resulting from hemoglobinuria and hemosiderinuria. Neutropenia and thrombocytopenia are common. As in chronic myelogenous leukemia (CML), the leukocyte alkaline phosphatase (LAP) score is reduced in PNH granulocytes. Acetylcholinesterase levels in the erythrocytes are also decreased.

The biochemical hallmark of PNH is the ability to demonstrate hemolysis of the patient's red cells when the pH is dropped to between 6.5 and 7.0. The Ham test involves the addition of acidified serum from a normal volunteer to the patient's red cells. The normal serum provides complement, which may be depleted in patients with PNH. Lysis in this tube as compared to control tubes, in which the normal serum has been heated to destroy complement, is virtually diagnostic of PNH. The sucrose hemolysis ("sugar water") test can be used as a simple

Hematology

screening test. Here the patient's blood is added to isotonic sucrose, which is a low ionic strength solution. Complement is activated by the reduced ionic strength, and hemolysis occurs. Since occasional false positives occur, positive results require confirmation with the more complex and rigorous Ham test.

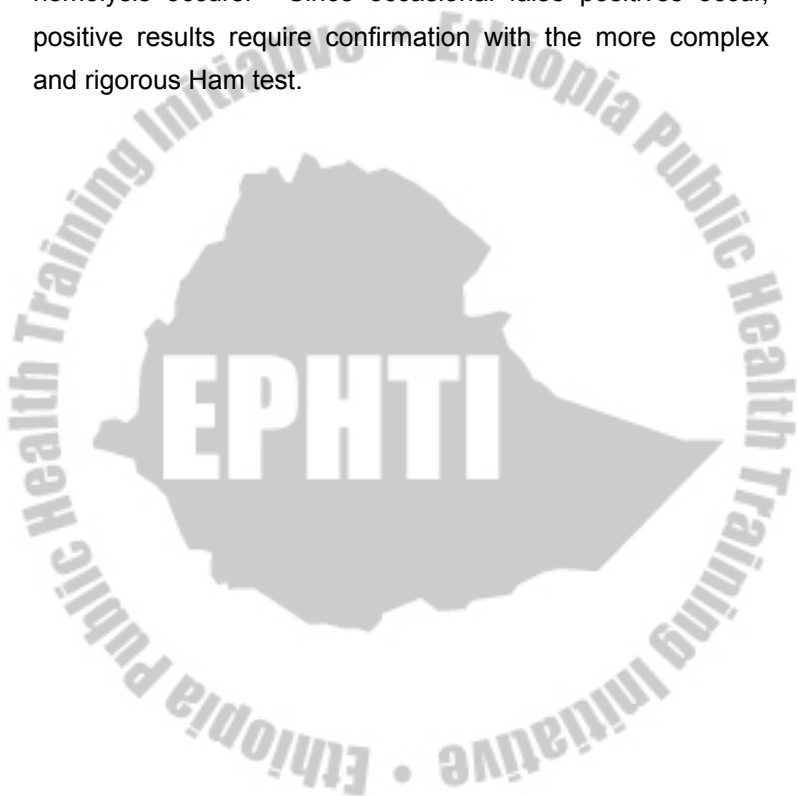

Review Questions

1. Define anemia
2. Describe the different methods of classifying anemia
3. Explain in brief microcytic anemia and the different forms included in this category
4. Describe macrocytic anemia
5. Describe normochromic normocytic anemia

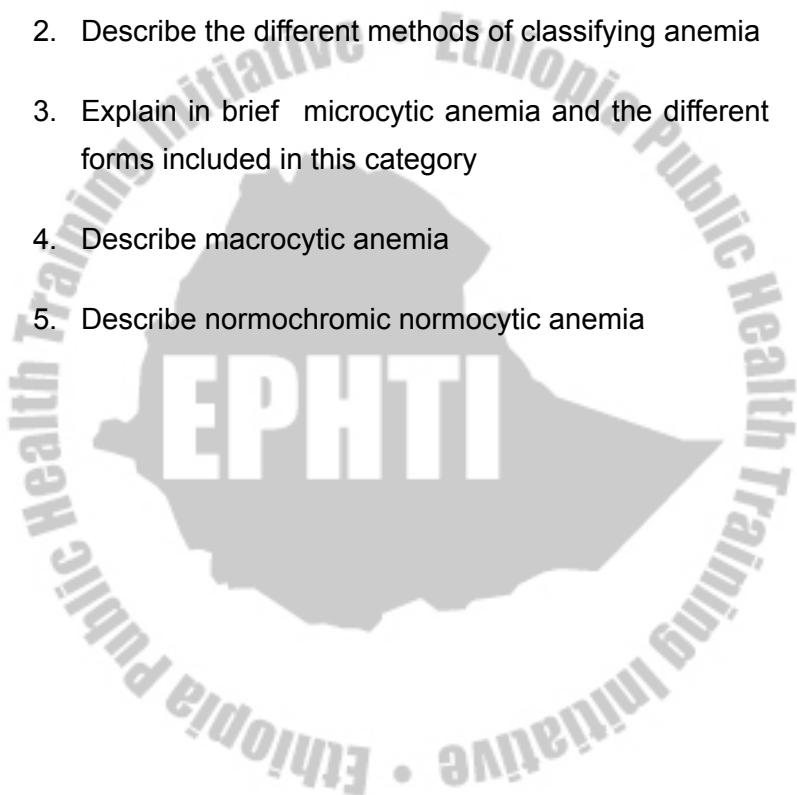

CHAPTER EIGHTEEN

HEMATOLOGICAL MALIGNANCIES

Learning objectives

At the end of this chapter, the student shall be able to:

- Describe the classification of leukemia
- Explain the diagnostic methodologies of leukemia
- Describe myelodysplastic syndrome
- Define malignant lymphoma
- Characterize multiple myeloma
- Describe myeloproliferative disorders

18.1. Leukemia

The leukemias are a group of disorders characterized by the accumulation of abnormal white cells in the bone marrow. These abnormal cells may cause bone marrow failure, a raised circulating white cell count and infiltrate organs. Thus common but not essential features include abnormal white cells in the peripheral blood, a raise total white cell count, evidence of bone marrow failure (i.e. anemia, neutropenia, thrombocytopenia) in

the acute leukemias and involvement of other organs (e.g. liver, spleen, lymph nodes, meninges, brain, skin or testes).

Although viruses cause several forms of leukemia in animals, their role in humans is uncertain; only two viral associations are identified: (1) Epstein-Barr virus, a DNA virus, is associated with Burkitt's lymphoma, and (2) human T-cell lymphotropic virus type I, called human T-cell leukemia/lymphoma virus, an RNA retrovirus, is associated with some T-cell leukemias and lymphomas, most commonly identified in Japan and the Caribbean. Exposure to ionizing radiation and certain chemicals (e.g., benzene, some antineoplastic drugs) is associated with an increased risk of leukemia. Some genetic defects (eg, Down syndrome, Fanconi's anemia) also predispose to leukemia.

The main classification of leukemia is into acute and chronic leukemia. Acute leukemia is further subdivided into acute myeloid (myeloblastic/myelogenous) leukemia (AML) and acute lymphoblastic (lymphocytic) leukemia (ALL) on the basis of morphology and cytochemistry.

AML is further subdivided into eight variants on a

morphological basis according to the French-American-British (FAB) scheme. ALL is subdivided on a morphological basis according to the FAB classification into L₁, L₂, L₃ types (Table 18.1). Immunophenotyping, chromosome and gene rearrangement studies are also used to distinguish AML from ALL and to subclassify them.

Table 18.1 Subtypes of AML and ALL according to the FAB group

AML Subtype	ALL subtype
M0: Undifferentiated	L1: blast cells small, uniform high
M1: Myeloid without maturation	Nuclear to cytoplasmic ratio
M2: Myeloid with maturation	L2: blast cells larger, heterogeneous,
M3: Acute promyelocytic	lower nuclear to cytoplasmic ratio
M4: Myelomonocytic	L3: vacuolated blasts, basophilic
M5: Monocytic/monoblastic leukemia	Cytoplasm
M6: Erythroleukemia	
M7: Megakaryoblastic	

The chronic leukemias comprise two main types, chronic myeloid leukemia (CML) and chronic lymphocytic

(lymphatic) leukemia (CLL). Other chronic types include hairy cell leukemia, prolymphocytic leukemia and various leukemia/lymphoma syndromes.

Acute leukemias

The leukemic cell population in ALL and AML probably result from clonal proliferation by successive divisions from a single abnormal stem or progenitor cell. In acute leukemia, in which there are over 50% myeloblasts or lymphoblasts in the bone marrow at clinical presentation, the blast cells fail to differentiate normally but are capable of further divisions. Their accumulation results in replacement of the normal hemopoietic precursor cells of the bone marrow by myeloblasts or lymphoblasts and, ultimately in bone marrow failure.

The clinical condition of the patient can be correlated with the total number of leukemic cells in the body. When the abnormal cell number approaches 10^{12} the patient is usually gravely ill with severe bone marrow failure. Peripheral blood involvement by the leukemic cells and infiltration of organs such as the spleen, liver and lymph nodes may not occur until the leukemic cell population comprised 60% or more of the marrow cell total.

The disease may be recognized by conventional morphology only when blast (leukemic) cells in the marrow exceed 5% of the cell total (unless the blast cells have some particular abnormal feature). This corresponds to a total cell count in excess of 10^8 . The clinical presentation and mortality in acute leukemia arises mainly from neutropenia, thrombocytopenia and anemia because of bone marrow failure and, less commonly, from organ infiltration, e.g. of the meninges or testes.

The acute leukemia comprise over half of the leukemias seen in clinical practice. ALL is the common form in children; its incidence is highest at 3-4 years, falling off by 10 years. There is a lower frequency of ALL after 10 years of age with a secondary rise after the age of 40. AML occurs in all age groups. It is the common form of acute leukemia in adults including the elderly.

Laboratory features

- A normochromic normocytic anemia
- The total white cell count may be decreased, normal or increased up to $200 \times 10^9/l$ or more

Hematology

- Thrombocytopenia in most cases, often extreme in AML
- Blood film examination typically shows variable numbers of blast cells. In AML, the blasts may contain Auer rods and other abnormal cells may be present, e.g. promyelocytes, myelocytes, agranular neutrophils, pseudo-Pelger cells or myelomonocytic cells. ALL must be differentiated from infectious mononucleosis and other causes of lymphocytosis.
- In AML M₆ (erythroleukemia) many erythroblasts may be found and these may also be seen in smaller numbers in other forms.
- The bone marrow is hypercellular with a marked proliferation of leukemic blast cells which amount to over 50% and typically over 75% of the marrow cell total. In ALL the marrow may be difficult to aspirate because of increased reticulin fiber. In AML M₇ the patient typically has an acute onset of Pancytopenia with marrow fibrosis.

Differentiation of ALL from AML

In most cases, the clinical features and morphology on routine staining separate ALL from AML. In ALL the blasts show no differentiation (with the exception of B-ALL) whereas in AML some evidence of differentiation to

granulocytes or monocytes is usually seen in the blasts or their progeny. Special test (e.g. cytochemistry, gene rearrangement studies and chromosome analysis) are needed when the cells are undifferentiated to confirm the diagnosis of AML or ALL and to subdivide cases of AML or ALL into their different subtypes.

Chronic myeloid leukemia

Chronic myeloid leukemia (CML) comprises <20% of all the leukemias and is seen most frequently in middle age. In over 95% of patients there is a replacement of normal bone marrow by cells with an abnormal chromosome- the Philadelphia or Ph chromosome. This is an abnormal chromosome 22 due to the translocation of part of a long (q) arm of chromosome 22 to another chromosome, usually 9, with translocation of part of chromosome 9 to chromosome 22. It is an acquired abnormality of hemopoietic stem cells that is present in all dividing granulocytic, erythyroid and megakaryocytic cells in the marrow and also in some B and probably a minority of T lymphocytes.

A great increase in total body granulocyte mass is responsible for most of the clinical features. In at least 70% of patients there is a terminal metamorphosis to

acute leukemia (myeloblastic or lymphoblastic) with an increase of blast cells in the marrow to 50% or more. This disease occurs in either sex (male: female, 1.4:1), most frequently between the ages of 40 and 60 years. However, it may occur in children and neonates and in the very old. In most cases there are no predisposing factors but the incidence was increased in survivors of the atom bomb exposures in Japan.

Laboratory findings

- Leucocytosis is usually $>50 \times 10^9/l$ and sometimes $>500 \times 10^9/l$. A complete spectrum of myeloid cells is seen in the peripheral blood. The levels of neutrophils and myelocytes exceed those of blast cells and promyelocytes.
- Ph chromosome on cytogenetic analysis of blood or bone marrow.
- Bone marrow is hypercellular with granulopoietic predominance.
- Neutrophil alkaline phosphatase score is invariably low
- Increased circulating basophils
- Normochromic, normocytic anemia is usual
- Platelet count may be increased (most frequently), normal or decreased

Hematology

- Serum vitamin B₁₂ and vitamin B₁₂-binding capacity are increased
- Serum uric acid is usually raised

Chronic lymphocytic leukemia

Chronic lymphocytic (lymphatic) leukemia (CLL) accounts for 25% or more of the leukemias seen in clinical practice. The disease occurs in older subjects and is rare before 40 years. The male to female ratio is 2:1. The accumulation of large numbers of lymphocytes to 50-100 times the normal lymphoid mass in the blood, bone marrow, spleen, lymph nodes and liver may be related to immunological non-reactivity and excessive lifespan. The cells are a monoclonal population of B lymphocytes. With advanced CLL there is often bone marrow failure, a tumorous syndrome with generalized discrete lymphadenopathy and sometimes soft tissue lymphoid masses; immunological failure results from reduced humoral and cellular immune processes with a tendency to infection.

Laboratory findings

- Lymphocytosis. The absolute lymphocyte count is $>5 \times 10^9/l$ and may be up to $300 \times 10^9/l$ or more. Between 70% and 99% of white cells in the blood

film appear as small lymphocytes. Smudge or smear cells are also present.

- Normocytic, normocytic anemia is present in later states due to marrow infiltration or hypersplenism. Autoimmune hemolysis may also occur.
- Thrombocytopenia occurs in many patients
- Bone marrow aspiration shows lymphocytic replacement of normal marrow elements. Lymphocytes comprise 25-95% of all the cells.
- Reduced concentrations of serum immunoglobulins are found and this becomes more marked with advanced disease. Rarely a paraprotein is present

Hairy cell leukemia

Hairy cell leukemia (HCL), also known as leukemic reticuloendotheliosis, is a slow growing leukemia. It is most common in older white males. It is an unusual disease of peak age 40-60 years and men are affected nearly four times as frequently as women. It is a type of chronic lymphoid leukemia. Hairy cell leukemia was first described by Bertha Bouroncle, M.D. and her colleagues at the OSU College of Medicine and Public Health at The Ohio State University in 1958.

This disorder is characterized clinically by features due

to Pancytopenia. The spleen may be moderately enlarged. There is a monoclonal proliferation of cells with an irregular cytoplasmic outline ('hairy' cells, a type of B lymphocyte) in the peripheral blood, bone marrow, liver and other organs. The number of hairy cells in the peripheral blood is variable; they may be rare. The bone marrow trephine shows a characteristic appearance of mild fibrosis and a diffuse cellular infiltrate. A serum paraprotein may be present and the patients may have arthritis, serositis or vasculitis.

18.2. Myelodysplastic Syndromes (Myelodysplasia)

The myelodysplastic syndromes (MDS) are a heterogeneous group of diseases states that usually present as peripheral blood cytopenias with a hypercellular bone marrow. The disease is most common in the elderly and males are more commonly affected. There is a tendency to progress to acute myeloid leukemia, although death often occurs before this develops.

As in the acute leukemias, the fundamental disorder is the clonal proliferation of stem cells that produce progeny that fail to mature normally. In the acute leukemias the maturation defect leads to the accumulation of blast cells. In MDS, in contrast, the maturation defect is more subtle; mature forms develop but they are often morphologically atypical (“dysplastic”) and frequently dysfunctional as well.

The MDS are classified into five subgroups:

1. Refractory anemia (RA)
2. RA with ring sideroblasts (RARS)
3. RA with excess blasts (RAEB)
4. RAEB in transformation (RAEB-t)
5. Chronic myelomonocytic leukemia (CMML)

Laboratory features

Peripheral blood:

- Pancytopenia is a frequent finding
- The red cells are usually macrocytic or dimorphic but occasionally hypochromic; normoblasts may be present
- The reticulocyte count is low
- Granulocytes are often reduced and may show lack of granulation. Their chemotactic, phagocytic and

adhesive functions are impaired.

- The Pelger abnormality (single or bilobed nucleus) is often present and in CMML monocytes are $>1.0 \times 10^9/l$ in the blood and the total white blood count may be $>100 \times 10^9/l$.
- The platelets may be unduly large or small and are usually decreased in number but in 10% of cases are elevated.
- In poor prognosis cases variable numbers of myeloblasts are present in the blood

Bone marrow:

- The cellularity is usually increased
- Ring sideroblasts may occur in all five FAB types
- Multinucleate normoblasts and other dyserythropoietic features are seen
- The granulocyte precursors show defective primary and secondary granulation, and cells which are difficult to identify as either agranular myelocytes, monocytes or promonocytes are frequent.
- Megakaryocytes are abnormal with micro-, small binuclear or polynuclear forms
- Bone marrow biopsy shows fibrosis in 10% of cases

18.3. Malignant Lymphomas

This group of diseases is divided into Hodgkin's disease and non-Hodgkin's lymphomas. In both, there is replacement of normal lymphoid structure by collections of abnormal cells, Hodgkin's disease being characterized by the presence of Reed-Sternberg (RS) cells and the non-Hodgkin's lymphomas by diffuse or nodular collections of abnormal lymphocytes or, rarely, histiocytes.

Hodgkin's disease

Hodgkin's disease (Hodgkin's lymphoma) is a type of lymphoma described by Thomas Hodgkin in 1832, and characterized by the presence of Reed-Sternberg cells. It is a malignant tumor closely related to the other malignant lymphomas. In many patients, the disease is localized initially to a single peripheral lymph node region and its subsequent progression is by contiguity within the lymphatic system. It is likely that the characteristic RS cells and the associated abnormal and smaller mononuclear cells are neoplastic and that the associated inflammatory cells represent a hypersensitivity response by the host, the effectiveness of which determines the pattern of evolution. After a variable period of containment within the lymph nodes,

the natural progression of the disease is to disseminate to involve non-lymphatic tissue.

The disease can present at any age but is rare in children. It has bimodal age incidence, one peak in young adults (age 20-30 years) and a second after the age of 50. In developed countries the ratio of young adults to child cases and of nodular sclerosing disease to other types is increased. There is an almost 2:1 male predominance.

Laboratory findings

- Normochromic, normocytic anemias is most common. With marrow infiltration, bone marrow failure may occur with a leuco-erythroblastic anemia.
- One-third of patients have a leucocytosis due to a neutrophil increase
- Eosinophilia is frequent
- Advanced disease is associated with lymphopenia
- The platelet count is normal or increased during early disease, and reduced in later stages
- The ESR is usually raised and is useful in monitoring disease progress.
- Bone marrow involvement is unusual in early

disease. It may be demonstrated by trephine biopsy, usually in patients with disease at many sites. Bilateral trephine biopsy is performed in some units.

- There is progressive loss of immunologically competent T lymphocytes with reduced cell-mediated immune reactions
- Infections are common, particularly herpes zoster, cytomegalovirus and fungal, e.g. *Cryptococcus* and *Candida*. Tuberculosis may occur
- Patients with bone disease may show hypercalcaemia, hypophosphataemia and increased levels of serum alkaline phosphatase.
- Serum lactate dehydrogenase (LDH) is raised initially in 30-40% of cases and indicates a poor prognosis
- Elevated levels of serum transaminases may indicate liver involvement
- Serum bilirubin may be raised due to biliary obstruction caused by large lymph nodes at the porta hepatis
- Hyperuricaemia may occur

Non-Hodgkin's lymphomas

The clinical presentation and natural history of these malignant lymphomas are more variable than in

Hodgkin's disease, the pattern of spread is not as regular, and a greater proportion of patients present with extranodal disease or leukemic manifestations.

Laboratory findings

- A Normochromic, normocytic anemia is usual but auto-immune hemolytic anemia may also occur.
- In advance disease with marrow involvement there may be neutropenia, thrombocytopenia (especially if the spleen is enlarged) or leuco-erythroblastic features
 - Lymphoma cells ('cleaved follicular lymphoma' or 'blast' cells) with variable nuclear abnormalities may be found in the peripheral blood in some patients.
 - Trepine biopsy of marrow shows focal involvement, usually paratrabecular, in 20% of cases. Diffuse infiltration often accompanied by fibrosis may also occur. Paradoxically, bone marrow involvement is found more frequently in low-grade malignant lymphomas.
- Elevation of serum uric acid may occur. Abnormal liver function tests suggest disseminated disease
- The serum LDH level is raised in more rapidly proliferating and extensive disease and may be used as a prognostic marker.

18.4. Multiple Myeloma

Multiple myeloma (myelomatosis) is a neoplastic monoclonal proliferation of bone marrow plasma cells, characterized by lytic bone lesions, plasma cell accumulation in the bone marrow, and the presence of monoclonal protein in the serum and urine. Ninety-eight percent of cases occur over the age of 40 with a peak incidence in the seventh decade.

Laboratory finding

- In 98% of patients monoclonal protein occurs in the serum or urine or both. The serum paraprotein is IgG in two-thirds, IgA in one-third, with rare IgM or IgD or mixed cases. Normal serum immunoglobulins (IgG, IgA and IgM) are depressed.
- The urine contains Bence-Jones protein in two-thirds of cases.
- The bone marrow shows increased plasma cells often with abnormal forms – ‘myeloma cells’. Immunological testing shows these cells to be monoclonal B cells and to express the same

immunoglobulin heavy and light chains as the serum monoclonal protein.

- There is usually a normochromic, normocytic or macrocytic anemia.
- Rouleaux formation is marked in most cases
- Neutropenia and thrombocytopenia occur in advanced disease
- Abnormal plasma cells appear in the blood film in 15% of patients.
- Leuco-erythroblastic changes are occasionally seen
- High ESR
- Serum calcium elevation occurs in 45% of patients.
- The blood urea is raised above 14mmol/l and serum creatinine raised in 20% of cases
- Proteinaceous deposits from heavy Bence-Jones proteinuria, hypercalcaemia, uric acid, amyloid and pyelonephritis may all contribute to renal failure
- A low serum album occurs with advance disease
- Serum β_2 -microglobulin (the light chain of the HLA class 1 antigens) is a useful indicator of prognosis. It partly reflects renal function. Levels less than 4mg/l imply a relatively good prognosis.

18.5 Myeloproliferative Disorders

The term myeloproliferative disorders describe a group of conditions characterized by clonal proliferation of one or more hemopoietic components in the bone marrow and, in many cases, the liver and spleen.

These disorders are closely related to each other; transitional forms occur and, in many patients, an evolution from one entity into another occurs during the course of the disease. Polycythemia vera (PV), essential thrombocythemia and myelofibrosis (increased connective tissue with decreased room for production of normal blood cells) are collectively known as the non-leukemic myeloproliferative disorders and are discussed here; chronic myeloid leukemia is discussed in leukemia subtopic.

Polycythemia vera

Polycythemia (erythrocytosis) refers to a pattern of blood cell changes that includes an increase in hemoglobin above 17.5g/dl in adult males and 15.5g/dl in females usually with an accompanying rise in red cell count (above $6.0 \times 10^{12}/l$ in males and $5.5 \times 10^{12}/l$ in females) and hematocrit (above 55% in males and 47% in females). Studies with ^{51}Cr -labelled red cells to measure total red cell volume (TRCV) and ^{125}I -albumin

to measure plasma volume are required to establish whether the polycythemia is 'real', where there is an increase in TRCV, or 'relative', where there is no increase in TRCV but the circulating plasma volume is decreased. Polycythemia is considered 'real' if the TRCV is greater than 36ml/kg in men and 32ml/kg in women.

In polycythemia vera (polycythemia rubra vera), the increase in red cell volume is caused by endogenous myeloproliferation. The stem cell origin of the defect is suggested in many patients by an over production of granulocytes and platelets as well as of red cells. This is a disease of older subjects with an equal sex incidence.

Laboratory findings

- The hemoglobin, hematocrit and red cell count are increased. The TRCV is increase
- A neutrophil leucocytosis is seen in over half the patients, and some have increased circulating basophils.
- A raised platelet count is present in about half the patients
- The neutrophil alkaline phosphatase score is usually increased above normal

Hematology

- Increased serum vitamin B₁₂ and vitamin B₁₂-binding capacity due to an increase in transcobalamin I.
- The bone marrow is hypercellular with prominent megakaryocytes, best assessed by a trephine biopsy. Clonal cytogenetic abnormalities may occur, but there is no single characteristic change
- Blood viscosity is increased
- Plasma urate is often increased
- Circulating erythroid progenitors are increased and grow in vitro independently of added erythropoietin.

Essential thrombocythemia

Megakaryocyte proliferation and overproduction of platelets is the dominant feature of this condition; there is sustained increase in platelet count above normal ($400 \times 10^9/l$).

The condition is closely related to PV. Some cases show patchy myelofibrosis. Recurrent hemorrhage and thrombosis are the principal clinical features. Splenic enlargement is frequent in the early phase but splenic atrophy due to platelets blocking the splenic microcirculation is seen in some patients.

There may be anemia (e.g. due to iron deficiency from

chronic gastrointestinal or uterine hemorrhage or due to the marrow disorder itself) or the thrombocythemia may be accompanied by polycythemia. The condition must be distinguished from other causes of a raised platelet count.

Laboratory findings

- Abnormal large platelets and megakaryocyte fragments may be seen in the blood film.
- The bone marrow is similar to that in PV. Cytogenetics are analyzed to exclude chronic myeloid leukemia.
- Platelet function tests are consistently abnormal, failure of aggregation with adrenaline being particularly characteristic.

Myelofibrosis

Myelofibrosis, one of the myeloproliferative diseases, is the gradual replacement of the bone marrow by connective tissue. This condition has many names: (chronic) myelofibrosis, myelosclerosis, agnogenic myeloid metaplasia, or myelofibrosis with myeloid metaplasia (MMM).

The replacement of the bone marrow tissue reduces the

patient's ability to generate new blood cells resulting in chronic anemia. A prime feature is "extramedullary hematopoiesis", i.e. the remaining blood-forming cells migrate to other sites in the body, e.g. the liver or spleen. Patients will typically have an enlarged spleen and liver, (hepatosplenomegaly), and examination of the blood cells will show "teardrop cells". Typically affecting patients more than 50 years old, it is a chronic and debilitating condition.

Hemopoietic stem cell proliferation is generalized with splenic and hepatic involvement. There is an increase in circulating stem cells associated with the establishment of extramedullary hemopoiesis. There is reactive fibrosis in the bone marrow secondary to hyperplasia of abnormal megakaryocytes. There is stimulation of fibroblasts probably by platelet –derived growth factor secreted by megakaryocytes and platelets and inhibition of collagenase by platelet factor IV.

Laboratory findings

- Anemia is usual but a normal or increased hemoglobin level may be found in some patients
- The white cell and platelet counts are frequently high at the time of presentation. Later in the disease

leucopenia and thrombocytopenia are common.

- A leuco-erythroblastic blood film is found. The red cells show characteristic 'tear-drop' poikilocytes.
- Bone marrow is usually unobtainable by aspiration. Trepine biopsy may show a hypercellular marrow with an increase in reticulin-fibre pattern; in other patients there is an increase in intercellular substance and variable collagen deposition. Increased megakaryocytes are frequently seen.
- Low serum and red cell folate, raised serum vitamin B₁₂ and vitamin B₁₂-binding capacity, and an increased neutrophil alkaline phosphatase score are usual.
- High serum urate, LDH and hydroxybutyrate dehydrogenase levels reflect the increased but largely ineffective turnover of hemopoietic cells. The serum LDH is normal in PV
- Extramedullary erythropoiesis may be documented by radio-iron studies or by liver biopsy, but these are not routine tests
- Transformation to acute myeloid leukemia occurs in 10-20% of patients.

Review Questions

1. Describe briefly the classification of leukemia
2. Explain the laboratory diagnosis of different form of leukemia
3. Define myelodysplastic syndrome and indicate the hematological findings
4. What is the features of malignant lymphoma
5. What is the characteristics multiple myeloma
6. Describe myeloproliferative disorders

CHAPTER NINETEEN

LEUCOCYTE CYTOCHEMISTRY

Learning objectives

At the end of this chapter, the student shall be able to:

- Define leucocyte cytochemistry
- Describe the importance of leucocyte cytochemistry in hematological investigation
- Explain the interpretation of various leucocyte cytochemistry results: myeloperoxidase, Sudan black B, neutrophil alkaline phosphatase, acid phosphates, periodic acid-shiff reaction, esterases, toluidine blue stain.

Introduction

Leucocyte cytochemistry encompasses the techniques used to identify diagnostically useful enzymes or other substances in the cytoplasm of hemopoietic cells.

These techniques are particularly useful for the characterization of immature cells in the acute myeloid leukemias, and the identification of maturation

abnormalities in the myeloproliferative disorders. The use of cytochemistry to characterize lymphoproliferative disorders has been largely superseded by immunological techniques.

The results of cytochemical tests should always be interpreted in relation to Romanowsky stains and immunological techniques. Control blood or marrow slides should always be stained in parallel to assure the quality of the staining.

The principal uses of cytochemistry are:

- To characterize the blast cells in acute leukemias as myeloid.
- To identify granulocytic and monocytic components of acute myeloid leukemia.
- To identify unusual lineages occasionally involved in clonal myeloid disorders, e.g. basophiles and mast cells.
- To detect of cytoplasmic abnormalities and enzyme deficiencies in myeloid disorders, e.g. myeloperoxidase-deficient neutrophils in myelodysplasia or acute leukemia, neutrophil alkaline phosphatase-deficient neutrophils in chronic myeloid leukemia.

19.1 Myeloperoxidase (MPO)

Myeloperoxidase is located in the primary and secondary granules of granulocytes and their precursors, in eosinophil granules and in the azurophil granules of monocytes. The MPO in eosinophil granules is cyanide resistant, whereas that in neutrophils and monocytes is cyanide sensitive.

MPO splits H_2O_2 , and in the presence of a chromogenic electron donor forms an insoluble reaction product. Various benzidine substitutes have been used, of which 3,3'-diaminobenzidine (DAB) is the preferred chromogen. The reaction product is stable, insoluble and non-diffusible. Staining can be enhanced by immersing the slides in copper sulphate or nitrate, but this is generally not required in normal diagnostic practice. Alternative non-benzidine based techniques employ 4-chloro-1-naphthol (4CN) or 3-amino-9-ethylcarbazole. The former gives very crisp staining, but is soluble in some mounting media and immersion oil, the latter shows some diffusibility and does not stain as strongly as DAB.

Interpretation of the result

The reaction product is brown and granular. Red cells and erythyroid precursors show diffuse brown cytoplasmic staining. The most primitive myeloblasts are negative, with granularly positively appearing progressively as they mature towards the promyelocyte stage. The positivity may be localized to the Golgi region. Promyelocytes and myelocytes are the most strongly staining cells in the granulocyte series, with positive (primary) granules packing the cytoplasm. Metamyelocytes and neutrophils have progressively fewer positive (secondary) granules.

Eosinophil granules stain strongly, and the large specific eosinophil granules are easily distinguished from neutrophil granules. Eosinophil granule peroxidase is distinct biochemically and immunologically from neutrophil peroxidase. Monoblasts and monocytes may be negative or positive. When positive, the granules are smaller than in neutrophils and diffusely scattered throughout the cytoplasm. MPO activity is present in basophil granules but is not demonstrable in mature basophils by the DAB reaction.

19.2. Sudan Black B

Sudan black B is a lipophilic dye that binds irreversibly to an undefined granule component in granulocytes, eosinophils and some monocytes. It cannot be extracted from the stained granules by organic dye solvents, and gives comparable information to that of MPO staining.

Interpretation of the result

The reaction product is black and granular. The results are essentially similar to those seen with MPO staining, both in normal and leukemic cells. MPO-negative neutrophils are also Sudan black B negative. The only notable difference is in eosinophil granules, which have a clear core when stained with Sudan black B. Rare cases of acute lymphoblastic leukemia (1-2%) show non-granular smudgy positivity not seen with MPO staining. Basophiles are generally not positive, but may show bright red/purple metachromatic staining of the granules.

19.3. Neutrophil Alkaline Phosphatase (NAP)

Alkaline phosphatase activity is found predominately in

mature neutrophils, with some activity in metamyelocytes. Although demonstrated as a granular reaction product in the cytoplasm, enzyme activity is associated with a poorly characterized intracytoplasmic membranous component distinct from primary or secondary granules. Other leucocytes are generally negative, but rare cases of lymphoid malignancies show cytochemically demonstrable activity. Bone marrow macrophages are positive. Early methods of demonstrating alkaline phosphatase relied on the use of glycerophosphate or other phosphomonoesters as the substrate at alkaline pH, with a final black reaction product of lead sulphide. Azo-dye techniques are simpler, giving equally good results. These methods use substituted naphthols as the substrate, and it is the liberated naphthol rather than phosphate that is utilized to combine with the azo-dye to give the final reaction product.

Interpretation of the result

The reaction product is blue and granular. The intensity of reaction product in neutrophils varies from negative to strongly positive, with coarse granules filling the cytoplasm and overlying the nucleus. An overall score is obtained by assessing the stain intensity in 100

Hematology

consecutive neutrophils, with each neutrophil scored on a scale of 1-4 as follows:

- 0 Negative, no granules
- 1 Occasional granules scattered in the cytoplasm
- 2 Moderate numbers of granules
- 3 Numerous granules
- 4 Heavy positively with numerous coarse granules crowding the cytoplasm, frequently overlying the nucleus

The overall possible score will range between 0 and 400. Reported normal ranges show some variations, owing possibly in part to variations in scoring criteria and methodology.

Published normal ranges illustrate the need for establishing a normal range in any one laboratory: Hayhoe & Quaglino = 14-100 (mean 46); Kaplow = 13-160 (mean 61); Rutenberg et al=37-98 (mean 68); Bendix-Hansen & Helleberg-Rasmussen=11-134 (mean 48)

The scoring system described by Bendix-Hansen & Helleberg-Rasmussen differs slightly in emphasis from the others, but gives similar results.

In normal individuals, it is rare to find neutrophils with scores of 3, and scores of 4 should not be present. There is some physiological variation in NAP scores. Newborn babies, children and pregnant women have high scores, and premenopausal women have, on average, scores one-third higher than men. In pathological states, the most significant diagnostic use of the NAP score is in chronic myeloid leukemia. In the chronic phase of the disease, the score is almost invariably low usually zero. Transient rises may occur with intercurrent infection. In myeloid blast transformation or accelerated phase, the score rises. Low scores are also commonly found in paroxysmal nocturnal hemoglobinuria (PNH) and the very rare condition of hereditary hypophosphatasia. There are many causes of a raised NAP score, notably in the neutrophilia of infection, polycythaemia rubra vera, leukemoid reactions and Hodgkin's disease. In aplastic anemia, the NAP score is high, but falls if PNH supervenes.

19.4. Acid Phosphatase Reaction

Cytochemically demonstrable acid phosphates is

ubiquitous in hemopoietic cells. The staining intensity of different cell types is somewhat variable according to the method employed. Its main diagnostic use is in the diagnosis of T-cell acute leukemias and hairy cell leukemia, but these diseases are more reliably diagnosed and characterized by immunophenotyping when this available, and the tartrate-resistant acid phosphates stain using Fast Garnet GBC as coupler is of historical interest only. The pararosaniline method given below, modified from Goldberg & Barka, is recommended for demonstrating positively in T lymphoid cells.

Interpretation of the result

The reaction product is red with a mixture of granular and diffuses positively. In T cells, acid phosphates are an early differentiation feature. Almost all acute and chronic T-cell leukemias show strong activity. In T-cell acute leukemias, the activity is usually highly localized (polar). Granulocytes are strongly positive. Monocytes, eosinophils and platelets show variable positivity. In the bone marrow, macrophages, plasma cells and megakaryocytes are strongly positive.

19.5 Periodic Acid-Schiff (PAS) Reaction

Periodic acid specifically oxidizes 1-2 glycol groups to product stable dialdehydes. These dialdehydes give a red reaction product when exposed to Schiff's reagent (leucobasic fuchsin). Positive reactions occur with carbohydrates, principally glycogen, but also monosaccharides, polysaccharides, glycoproteins, mucoproteins, phosphorylated sugars, inositol derivatives and cerebrosides. Glycogen can be distinguished from other positively reacting substances by its sensitivity to diastase digestion. In hemopoietic cells, the main source of positive reactions is glycogen.

Interpretation of the result

The reaction product is red, with intensity ranging from pink to bright red. Cytoplasmic positivity may be diffuse or granular. Granulocyte precursors show diffuse weak positivity, with neutrophils showing intense confluent granular positivity. Eosinophil granules are negative, with diffuse cytoplasmic positivity. Basophiles may be negative but often show large irregular blocks of positive material not related to the granules. Monocytes and their precursors show variable diffuse positivity with superimposed fine granules, often at the periphery of the cytoplasm. Normal erythroid precursors and red cells

are negative. Megakaryocytes and platelets show variable, usually intense, diffuse positivity with superimposed fine granules, coarse granules and large blocks. 10-40% of peripheral lymphocytes show granular positivity with negative background cytoplasm, with not detectable differences between T and B cells.

19.6. Esterases

Leucocyte esterases are a group of enzymes that hydrolyse acyl or chloroacyl esters of α -naphthol or naphthol AS. Li et al identified nine esterase isoenzymes using polyacrylamide gel electrophoresis of leucocyte extracts from normal and pathological cells. The gels were stained in parallel with cell smears. The isoenzymes fell into two groups: bands 1,2,7,8 and 9 corresponded to the "specific" esterase of granulocytes, staining specifically with naphthol AS-D chloroacetate esterase (chloroacetate esterase, CAE), while bands 3,4,5 and 6 corresponded to "non-specific" esterase (NSE), staining with α -naphthyl acetate esterase (ANAE) and α -naphthyl butyrate esterase (butyrate esterase, BE). Band 4 was best demonstrated by BE

and band 5 by ANAE.

The non-specific esterases are inhibited by sodium fluoride (NaF). Naphthol AS acetate and naphthol AS-D acetate react with both specific and non-specific esterases, but only the reaction with the non-specific esterases is inhibited by NaF. The methods employing parallel slides with and without NaF are not generally used anymore, as it is generally more informative to perform a combination of chloroacetate esterase and one of the “non-specific” esterase stains on a single slide. The combined methods have the advantage of demonstrating pathological double staining of individual cells. All the esterase stains can be performed using a variety of coupling reagents, each of which gives a different colored reaction product. The methods outlined below have been chosen for their simplicity and reliability.

Interpretation of the result with AS-D chloroacetate esterase

The reaction product is bright red. It is confined to cells of the granulocyte series and mast cells. Cytoplasmic CAE activity appears as myeloblasts mature to promyelocytes. Positivity in myeloblasts is rare, but

promyelocytes and myelocytes stain strongly, with reaction product filling the cytoplasm. Later granulocytes stain strongly but less intensely. It is therefore useful as a marker of cytoplasmic maturation in the granulocytic leukemias. In acute promyelocytic leukemia, the cells show heavy cytoplasmic staining. The characteristic multiple Auer rods stain positively, often with a hollow core. It is rare to see CAE-positive Auer rods in other forms of AML except cases with the t (8; 21) translocation.

Interpretation of the result with α -Naphthyl butyrate esterase

The reaction product is brown and granular. The majority of monocytes (>80%) stain strongly, the remainder showing some weak staining. Negative monocytes are rare. Neutrophils, eosinophils, basophils and platelets are negative. B lymphocytes are negative and T lymphocytes are unreliably stained. In the bone marrow, monocytes, their precursors and macrophages stain strongly. α -naphthyl butyrate is more specific for identifying a monocytic component in AML than α -naphthyl acetate.

Interpretation of result with α -naphthyl Acetate

Esterase

The reaction product is diffuse red/brown in color. Normal and leukemic monocytes stain strongly. Normal granulocytes are negative, but in myelodysplasia or AML may give positive reactions of varying intensity. Megakaryocytes stain strongly, and leukemic megakaryoblasts may show focal or diffuse positivity. Most T lymphocytes and some T lymphoblasts show focal “dot-like” positivity, but Immunophenotyping has superseded cytochemistry for identifying and subcategorizing T cells. Leukemic erythroblasts may show focal or diffuse positivity.

Interpretation of result with sequential combined esterase stain using ANAE and CAE

The ANAE gives a brown reaction product, the CAE a granular bright blue product. Staining patterns are identical to those seen with the two stains used separately. The double-staining technique avoids the need to compare results from separate slides, and shows up aberrant staining patterns. In myelomonocytic leukemias, cells staining with both esterases may be present. In myelodysplasia and AML with dysplastic granulocytes, double staining of individual cells may be present. This may be helpful in the diagnosis of dubious

cases of myelodysplasia, but the same abnormal pattern may be seen in non-clonal dysplastic states such as megaloblastic anemia.

Interpretation of result with Single incubation of double esterase (Naphthol AS-D chloroacetate (CAE) and α -naphthyl butyrate)

The CAE reaction product is bright blue (granulocytes); the ANB product is dark green/brown (monocytes). ANB does not stain megakaryocytes or T cells as strongly as α -naphthyl acetate. Lam et al suggest the use of hexazotized pararosaniline as coupling reagent in a single incubation combined esterase, which gives contrasting bright red and brown reaction products.

In AML, the stain is useful for identifying monocytic and granulocytic components.

19.7. Toluidine Blue Stain

Toluidine blue staining is useful for the enumeration of basophiles and mast cells. It binds strongly to the granules in these cells, and is particularly useful in pathological states where the cells may not be easily

identifiable on Romanowsky stains. In AML, CML and other myeloproliferative disorders, basophiles may be dysplastic and poorly granular, as may the mast cells in some forms of acquired mastocytosis.

Interpretation of the result

The granules of basophils and mast cells stain a bright red/purple, and are discrete and distinct. Nuclei stain blue, and cells with abundant RNA may show a blue tint to the cytoplasm. Although toluidine blue is said to be specific for these granules, with >10 min incubations, the primary granules of promyelocytes are stained red/purple. However, these are smaller and finer than the mast cell or basophil granules and are easily distinguished.

Review Questions

1. What is leucocyte cytochemistry
2. Describe the importance of leucocyte cytochemistry in hematological investigation
3. Explain the interpretation of various leucocyte cytochemistry results: myeloperoxidase, Sudan black B, neutrophil alkaline phosphatase, acid phosphates, periodic acid-shiff reaction, esterases, toluidine blue stain.

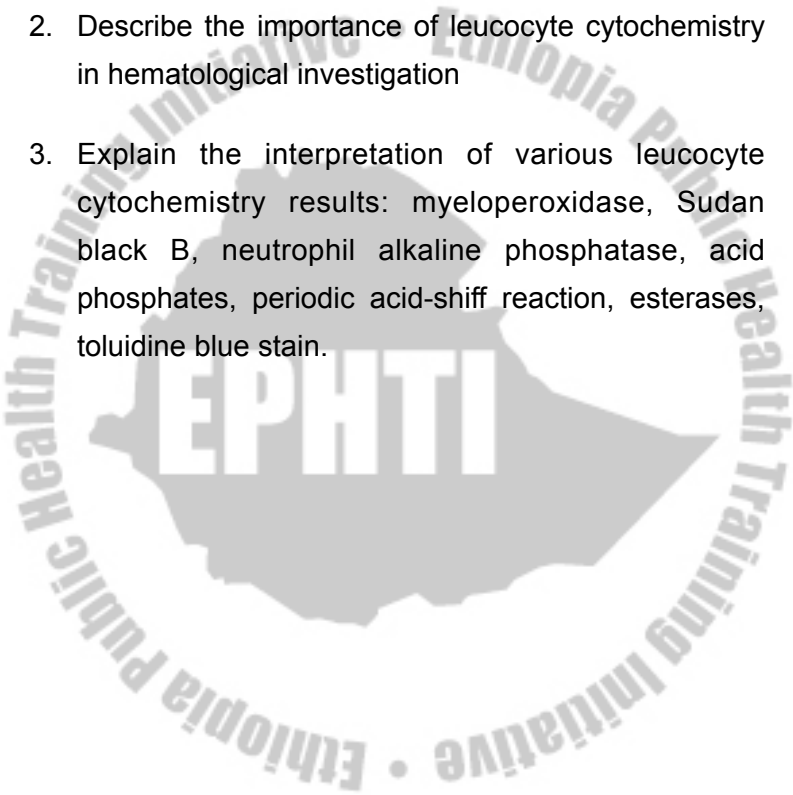

CHAPTER TWENTY

HEMOSTASIS

Learning objectives

At the end of this chapter, the student shall be able to:

- Describe normal and abnormal hemostasis
- Discuss how the components of normal hemostasis interact with each other to bring about normal blood flow within the vascular system
- Explain the intrinsic and extrinsic pathways of blood coagulation
- Discuss the normal control of the clotting process and the fibrinolytic system
- State the principles of the different tests of the bleeding disorders
- Perform the different tests of the bleeding disorders
- Indicate the normal values of the different tests of the bleeding disorders

Hematology

Introduction



Hemostasis (haima=blood and stasis=arrest) is a complex process which continually ensures prevention of spontaneous blood loss, and stops hemorrhage caused by damage to the vascular system. It is initiated by vascular injury and culminates in the formation of a firm platelet-fibrin barrier that prevents the escape of blood from the damaged vessel. Vascular damage exposes subendothelial structures to flowing blood, and blood platelets adhere and aggregate on the injured site. Simultaneously, coagulation proteins are sequentially activated to generate thrombin. Thrombin cleaves plasma fibrinogen into fibrin monomers, and thus polymerize to form a fibrin mesh over the adherent, aggregated platelets. Blood loss is thereby minimized. Platelet contractile activity then draws the attached fibrin polymers more tightly over the injured vascular surface and away from the luminal blood flow. These hemostatic processes are optimally effective in constricted blood vessels. Plasmin, the active fibrinolytic enzyme generated on fibrin polymers, subsequently hydrolyzes the fibrin to soluble fragments. Properly constructed and metabolically intact vascular wall components, adequate numbers of functional platelets, and sufficient quantities of coagulation proteins are all necessary for normal hemostasis.

Blood vessels

Vascular factors reduce blood flow from trauma by local vasoconstriction (an immediate reaction to injury) and compression of injured vessels by blood extravasated into surrounding tissues. Endothelial cells line blood vessel walls and synthesize von Willebrand factor (vWF) multimers. These multimers are composed of 230000 dalton monomers covalently linked by disulfide bonds into structures with molecular weights in the millions of daltons. vWF multimers are secreted into the circulation or onto the collagen-containing subendothelium. Following endothelial cell damage and subendothelial exposure, platelets bind to vWF multimers and collagen to initiate hemostasis.

Endothelial cells also synthesize and secrete prostaglandin I₂ (PGI₂ or prostacyclin), a vasodilator that prevents excessive platelet accumulation and occlusive platelet thrombi on subendothelial surfaces after minor vascular injury. PGI₂ stimulates platelet membrane adenylate cyclase and increases platelet cyclic adenosine monophosphate (cAMP) levels. Increased platelet cAMP levels impair platelet-to-platelet cohesion (aggregation) and suppress platelet release of

adenosine diphosphate (ADP) and other granule contents. cAMP-stimulated protein kinase-mediated phosphorylation of platelet membrane or cytoplasmic proteins may be responsible for these inhibitory effects.

Prostaglandin I₂ is synthesized from the arachidonic acid that membrane lipases liberate from endothelial cell membrane phospholipids. Endothelial cell fatty acid cyclooxygenase converts arachidonic acid to short-lived cyclic hydroperoxy (PGG₂) and hydroxy (pGH₂) intermediates, and then via prostacyclin synthetase to PG_I₂. Prostaglandin I₂ can also be synthesized directly from and PGG₂ and PGH₂ that diffuse into endothelial cells from nearby aggregating platelets.

Platelets

Normal blood contains 150000 to 350000 platelets per μl . These disk-shaped cells with a diameter of 2 to 3 μm are derived from marrow megakaryocytes. Platelet survival in the blood is normally about 10 days.

In contrast to megakaryocytes, platelets have no nucleus (DNA) and cannot synthesize protein. Plasma coagulation factors are adsorbed onto their surface membranes and several are present in platelet granules.

Platelet cytoplasm contains glycogen, mitochondria, enzymes of the glycolytic and hexose monophosphate pathways, microtubules, actin, myosin, and three different types of granules. These are lysosomes, dense granules, and α -granules. Platelet lysosomes contain hydrolytic enzymes. Dense granules contain adenosine triphosphate and diphosphate (ATP and ADP), calcium, and serotonin. Platelet α -granules contain: β -thromboglobulin, a glycopeptide of unknown function; platelet factor IV, a positively charged glycopeptide capable of binding negatively charged molecules (including heparin); platelet-derived growth factor (PDGF), a glycopeptide that promotes replication of smooth muscle cells and fibroblasts; and several proteins also present in plasma (factor V, vWF, fibrinogen, fibronectin).

When subendothelial structures are exposed to flowing blood, platelets adhere to collagen, bind vWF multimers via specific membrane receptors, change shape from disks to spiny spheres, and release their granule contents. ADP, a potent platelet-aggregating agent released from dense granules, alters the surface of platelets passing by in the flowing blood. The altered platelet membranes bind fibrinogen from surrounding

plasma via the glycoprotein IIb-IIIa complex, and aggregate onto the platelets already adherent to subendothelial vWF and collagen.

Thrombin, generated by the activation of the coagulation cascade, amplifies platelet aggregation and release responses. Platelet adherence to collage, as well as thrombin-induce aggregation, causes a change in platelet membrane structure. Collage and thrombin activate platelet membrane lipases, which then hydrolyze arachidonic acid from ester bonds in platelet membrane phospholipids. In a process similar to endothelial cell synthesis of PGI_2 , platelet fatty acid cyclooxygenase rapidly converts arachidonic acid to the cyclic endoperoxides PGG_2 and PGH_2 . Instead of prostacyclin synthetase, however, platelets contain the enzyme thromboxane synthetase that produces thromboxane A_2 from PGH_2 . Thromboxane A_2 , a short-lived prostaglandin derivative, potentiates the release of platelet granule contents. Any thromboxane A_2 that leaks from activated platelets also induces other platelets to aggregate, and stimulates local vasoconstriction. It is hydrolyzed rapidly and nonenzymatically into an inactive end

product, thromboxane B₂.

Coagulation cascade

By international agreement and common usage, the coagulation proteins are designated by Roman numerals: factor I (fibrinogen) through XIII. Numeral VI is not used. The numerical order does not reflect reaction sequence. Roman numerals are not used for prekallikrein and high molecular weight kininogen. The activated form of a coagulation factor is indicated by the appropriate Roman numeral followed by the suffix "a". For example, factor II (prothrombin) is cleaved to the active enzyme, thrombin (IIa).

Although there may be other sites of synthesis, hepatic cells probable synthesize and secrete most of the proteins involved in coagulation, including factor VIII. Endothelial cells and megakaryocytes synthesize and secrete vWF multimers. vWF multimers form ionic bonds with factor VIII molecules and transport this protein in the circulation. Hepatic synthesis of factor II, VII, IX, and X, is vitamin K-dependent.

In the final common pathway of the coagulation cascade, thrombin converts soluble, circulating fibrinogen into insoluble fibrin polymers. Thrombin

Hematology

generation occurs through two different reaction sequences, the intrinsic and extrinsic coagulation pathways.



Table 20.1 Coagulation Factors and their Synonyms

Coagulation factor	Synonyms
I	Fibrinogen
II	Prothrombin
III	Tissue factor (thromboplastin)
IV	Calcium ions
V	Proaccelerin, labile factor, or accelerator globulin
VII	Serum prothrombin conversion accelerator (SPCA), stable factor, or proconvertin.
VIII	Antihemophilic factor (AHF), antihemophilic factor A, or antihemophilic globulin (AHG)
IX	Christmas factor, plasma thromboplastin component (PTC), or antihemophilic factor B.
X	Stuart factor, Power factor, thrombokinase
XI	Plasma thromboplastin antecedent (PTA), or Antihemophilic factor C
XII	Hageman Factor, glass factor, or contact factor
XIII	Fibrin-stabilizing factor (FSF), or fibrinase
Prekallikrein	Fletcher factor
HMWK	Fitzgerald Factor

* There is no factor VI. HMWK, high molecular weight kininogen

Intrinsic coagulation: Intrinsic coagulation pathways

All necessary components for the intrinsic coagulation pathway are present (intrinsic) in the circulating blood.

Hematology

Adsorption of factor XII and kininogen (with bound prekallikrein and factor XI) to negatively charged subendothelial structures exposed at sites of vascular damage initiates the pathway. Subendothelial adsorption alters and partially activates the factor XII molecule to factor XIIa by exposing an active protease site. Factor XIIa then cleaves nearby kininogen-bound prekallikrein and factor XI molecules to create their active enzyme forms, kallikrein and XIa. In a feedback mechanism, kallikrein cleaves partially activated XIIa molecules adsorbed onto subendothelium to produce a form that is kinetically even more effective in the proteolytic conversion of prekallikrein and factor XI to kallikrein and XIa, respectively.

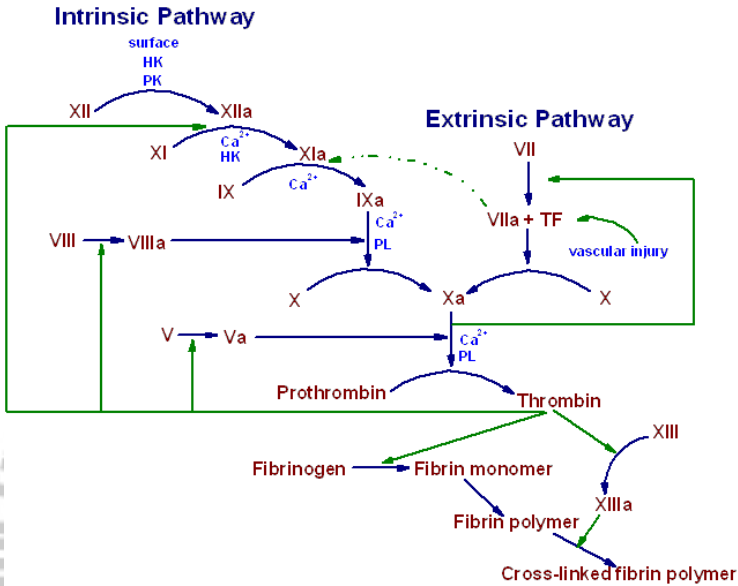

Fig. 20.1 coagulation pathway

Calcium is not required for the activation of factor XII, prekallikrein, or factor XI, but is necessary for the proteolytic activation of factor IX by XIa. Factor IX that has been proteolytically activated to IXa (by XIa) interacts with VIII on platelet or endothelial cell surfaces.

Factor VIII circulates in complexes with vWF multimers. These complexes bind to membrane surfaces by a mechanism yet to be determined, and the VIII molecules are cleaved by thrombin (or factor Xa) to a more active

form. Activated VIII then interacts with surface-bound IXa. In association with activated VIII, IXa is optimally effective in cleaving and activating nearby factor X molecules. Factor X also binds to membranes by calcium bridges between γ -carboxyglutamic acid residues in X and surface phospholipids. Following the activation of X to Xa, Xa remains platelet-bound and attaches to activated factor V molecules (Va). Factor V is either adsorbed from plasma and then cleaved and activated to Va by thrombin, or released in Va form from platelet α -granules. The complex of Xa-Va on the platelet surface is formed near prothrombin (II) molecules.

The Xa in these platelet-bound Xa-Va-II complexes cleaves the prothrombin (II) molecules into two portions. One portion contains all the γ -carboxyglutamic acid residues and may remain bound transiently to the platelets through calcium bridges. The other portion is freed into the blood as thrombin (IIa). Thrombin induces local platelet aggregation and can activate factors VIII and V. Thrombin also produces fibrin monomers from plasma fibrinogen molecules, and cleaves and activates factor XIII to a form (XIIIa) that covalently links fibrin monomers into fibrin polymers.

Extrinsic coagulation: Extrinsic coagulation pathway

Thrombin and fibrin polymers can also be formed via the extrinsic pathway, initiated by tissue factor, an integral membrane glycoprotein. This protein is normally found on fibroblasts, but can also be expressed by white blood cells, smooth muscle cells, and endothelial cells in some situations. The vitamin k-dependent proenzyme, factor VII, binds via γ -carboxyglutamic acid residues and calcium bridges to tissue factor on cell membranes, and is thereby activated to VIIa. VIIa is able to convert factor X to Xa, which is then able to activate prothrombin by mechanisms similar to those describe previously.

Normally, the extrinsic and intrinsic pathways are complementary mechanisms and both are essential for the formation of adequate amounts of factor Xa and thrombin in vivo. The factor VII-tissue factor complex, however, is also able to directly convert factor IX to factor IXa and subsequently factor X to factor Xa. This capacity of the extrinsic system to bypass the earliest reactions of the intrinsic cascade may explain the relatively mild hemorrhagic tendency that has been noted in patients with hereditary factor XI deficiency.

Regulatory mechanisms

Regulatory mechanisms normally prevent activated coagulation reactions from causing local thrombosis or disseminated intravascular coagulation (DIC). These mechanisms include neutralization within the blood of the enzymes and activated cofactors of coagulation and clearance of activated clotting factors, especially during hepatic circulation.

In addition to tissue factor pathway inhibitor, other plasma protease inhibitors (antithrombin III, α_2 -macroglobulin, α_1 -antiprotease, heparin cofactor II) can neutralize coagulation enzymes. The most important is antithrombin III (adding heparin to blood in vitro converts antithrombin III from a slow to an instantaneous inhibitor of the key enzymes thrombin, factor Xa, and factor IXa, which is the mechanism for heparin's therapeutic effect). Heparin-like chains on the luminal surface of vascular endothelium enhance the function of antithrombin III in vivo.

Inhibition of factors VIIIa and Va involves two vitamin K-dependent proteins, protein C and protein S. Thrombin, when bound to a receptor on endothelial cells called thrombomodulin, can cleave a small peptide from and thus activate protein C. Activated protein C is a serine

protease, which (with protein S and procoagulant phospholipid as its cofactors) catalyzes proteolysis of factors VIIIa and Va, which destroys their cofactor function.

Factor V Leiden is a genetic mutation (substitution of arginine with glutamine at position 506) that decreases degradation of factor Va by activated protein C. The heterozygous state is extremely common (3 to 15%) in various populations (averaging 7% in the USA) and results in increased incidence of venous thromboembolism. These clinical observations establish the physiologic importance of the protein C/protein S mechanism for regulating coagulation.

Fibrinolysis

The fibrinolytic system is activated by fibrin deposition. By dissolving fibrin, this system helps keep open the lumen of an injured blood vessel. A balance between fibrin deposition and lysis maintains and remodels the hemostatic seal during repair of an injured vessel wall. Plasmin is a powerful proteolytic enzyme that catalyzes fibrinolysis. Plasmin arises from an inert plasma precursor, plasminogen, through cleavage of a single arginine-valine peptide bond. Plasminogen activators catalyze this cleavage. Fibrin is first degraded into large

fragments (X and Y) and then into smaller fragments (D and E). These soluble fibrin degradation products are swept into the circulation.

When fibrinogen is converted to fibrin, lysine residues become available on the molecule to which plasminogen can bind tightly by way of lysine-binding sites. Two types of plasminogen activators triggering lysis of intravascularly deposited fibrin are released from vascular endothelial cells. One type, tissue plasminogen activator (tPA), is a poor activator when free in solution but an efficient activator when it and plasminogen bind to fibrin in proximity to each other. The second type, urokinase, exists in single-chain and double-chain forms with different functional properties. Endothelial cells release single-chain urokinase plasminogen activator, which cannot activate free plasminogen but, similar to tPA, can readily activate plasminogen bound to fibrin. A trace concentration of plasmin cleaves single-chain to double-chain urokinase plasminogen activator, which is an equally potent activator of plasminogen in solution and of plasminogen bound to fibrin. Epithelial cells that line excretory ducts (eg, renal tubules, mammary ducts) also secrete urokinase, which is thought to be the physiologic activator of fibrinolysis in these channels. Streptokinase, a bacterial product not normally found in

the body, is another potent plasminogen activator. Streptokinase and recombinant tPA (alteplase) have each been used therapeutically to induce fibrinolysis in patients with acute thrombotic disorders.

Plasma contains plasminogen activator inhibitors (PAIs) and plasmin inhibitors that slow fibrinolysis. PAI-1, the most important PAI, is released from vascular endothelium and activated platelets. The primary plasmin inhibitor is α_2 -antiplasmin, which can very rapidly inactivate free plasmin escaping from a fibrin clot. Some α_2 -antiplasmin is also cross-linked, by factor XIIIa, to fibrin during clotting; it regulates the activity of plasminogen activated to plasmin on fibrin. Plasma also contains histidine-rich glycoprotein, which is not a serine protease inhibitor but competes for lysine-binding sites on plasminogen, thus reducing the plasma concentration of plasminogen molecules with free lysine-binding sites.

Several factors normally prevent excessive fibrinolysis. tPA and urokinase released from endothelial cells have short intravascular half-lives because of their rapid inactivation by PAI-1 and because of their rapid clearance from blood flowing through the liver. The activity of tPA and single-chain urokinase plasminogen activator is markedly enhanced for plasminogen bound

to fibrin, which limits physiologic fibrinolysis to fibrin without accompanying proteolysis of circulating fibrinogen. Moreover, plasmin escaping from the fibrin surface is almost instantaneously neutralized by α_2 -antiplasmin.

When regulatory mechanisms fail, patients may bleed from excessive fibrinolysis. Rarely, patients have an essentially total hereditary deficiency of α_2 -antiplasmin. Their severe tissue bleeding after trivial injury establishes α_2 -antiplasmin as a key regulator of normal fibrinolysis. An occasional patient with decompensated chronic liver disease may bleed uncontrollably because of excessive fibrinolysis thought to partially stem from acquired severe α_2 -antiplasmin deficiency (secondary to diminished hepatocellular synthesis plus increased consumption caused by excessive plasminogen activator activity). Acquired α_2 -antiplasmin deficiency can also result from consumption of the inhibitor in fibrinolysis secondary to extensive DIC. This may contribute to the bleeding tendency in patients in whom DIC complicates prostate cancer or acute promyelocytic leukemia.

Laboratory Findings

Table 20.2 summarizes the principal laboratory tests for each phase of hemostasis. Screening tests measure combined effects of factors that influence a particular phase of coagulation (eg, bleeding time). Specific assays measure the level or function of one hemostatic factor (eg, factor VIII assay). Additional tests may measure a product or effect of pathologic in vivo activation of platelets, coagulation, or fibrinolysis (eg, level of fibrin degradation products). Screening test results and knowledge of the clinical disorder guide the selection of more specific diagnostic tests.

Table 20.2 Laboratory tests of hemostasis

Test	Purpose
Platelet count	Quantitates platelet number
Bleeding time	Screens for overall adequacy of formation of hemostatic plugs independent of blood coagulation reactions
Partial thromboplastin time	Screens for the factors involved when coagulation is initiated by contact activation reactions (fibrinogen; prothrombin; factors V, VIII, IX, X, XI, and XII; prekallikrein; high mol wt kininogen)
Prothrombin time	Screens for the factors involved when coagulation is initiated with a high concentration of tissue factor (fibrinogen; prothrombin; factors V, VII, and X)

Hematology

Thrombin time	Screens the last step of coagulation, the thrombin-fibrinogen reaction.; is prolonged with increased plasma antithrombin activity (e.g. when plasma contains heparin) and with conditions resulting in qualitative abnormalities of fibrinogen or hypofibrinogenemia
Specific functional assays for prothrombin and factors V to XII	Determines activity as a percentage of normal by comparing the ability of a test plasma and dilutions of a normal reference plasma to shorten the clotting time (in a PTT- or PT- based one-stage assay system) of a substrate plasma deficient in the specific factor being measured.
Euglobulin lysis time	Is shortened when blood contains increased plasminogen activator or plasmin activity
Platelet factor IV assay	Reflects release of platelet alpha granule contents into the plasma secondary to platelet activation in vivo

The **bleeding time** should be assessed with a BP cuff on the upper arm inflated to 40 mm Hg, which makes hemostatic plugs hold against a back pressure. A disposable, spring-loaded bleeding time device is used to make a 6-mm × 1-mm incision on the volar aspect of the forearm. Blood is absorbed onto the edge of a piece of filter paper at 30-sec intervals until bleeding stops. By this method, the upper limit of normal bleeding time is 7.5 min. Thrombocytopenia, disorders of platelet function, and von Willebrand's disease (VWD) may prolong the bleeding time, but it is not prolonged in coagulation-phase disorders. Use of aspirin within 5 to 7 days also prolongs bleeding time.

Partial thromboplastin time (PTT) screens for abnormal blood coagulation reactions triggered by exposure of plasma to a negatively charged surface. Plasma is incubated for 3 min with a reagent supplying procoagulant phospholipid and a surface-active powder (eg, micronized silica). Ca is then added, and the clotting time is noted. (Because commercial reagents and instrumentation vary widely, each laboratory should determine its own normal range; 28 to 34 sec is typical.) The PTT is sensitive to deficiencies of 30 to 40% of all clotting factors except factors VII and XIII. With rare exceptions, a normal result rules out hemophilia. Heparin prolongs the PTT, and the PTT is often used to monitor heparin therapy. A prolonged test time can also stem from a deficiency of one or more coagulation factors or from the presence of an inhibitor of a plasma clotting factor (eg, a factor VIII anticoagulant) or an inhibitor of procoagulant phospholipid (lupus anticoagulant). If an inhibitor is present, mixing the patient's plasma 1:1 with normal plasma will fail to shorten the PTT test result to within about 5 sec of the time obtained with normal plasma alone. Assays for specific coagulation factors can usually pinpoint the cause of a prolonged PTT not readily explained by other clinical findings.

In the **prothrombin time (PT) test**, plasma is recalcified in the presence of a high concentration of a tissue factor reagent (tissue thromboplastin). The test screens for abnormalities of factors V, VII, and X; prothrombin; and fibrinogen; and the normal PT varies between 10 and 12 sec, depending on the tissue factor reagent and other technical details. A PT ≥ 2 sec longer than a laboratory's normal control value should be considered abnormal and requires explanation. PT is valuable in screening for disordered coagulation in various acquired conditions (eg, vitamin K deficiency, liver disease, DIC). PT is also used to monitor therapy with coumarin anticoagulants. The therapeutic range of PT depends on the thromboplastin used in each laboratory. The **international normalized ratio (INR)**—normal = 0.9 to 1.1) has been introduced by the WHO to standardize control of anticoagulant therapy internationally. The INR is the ratio of patient PT to control PT raised to the power of the international sensitivity index (ISI), which is determined by comparing each reagent with WHO thromboplastin:

$$\text{INR} = \left[\frac{\text{patient PT (sec)}}{\text{control PT (sec)}} \right]^{\text{ISI}}$$

To determine the **thrombin time**, test plasma and a normal control plasma are clotted by adding a bovine thrombin reagent diluted to give a clotting time of about 15 sec for the control plasma. Because the test is independent of the reactions that generate thrombin, it is used to screen specifically for abnormalities affecting the thrombin-fibrinogen reaction: heparin, large fibrin degradation products, and qualitative abnormalities of fibrinogen. It is particularly useful in establishing whether a plasma sample contains heparin (eg, residual heparin not neutralized after an extracorporeal bypass procedure or contaminated plasma obtained from blood drawn from a line kept open with heparin flushes). In plasma that contains heparin, the thrombin time will be prolonged, but a repeat test will be normal if the reagent batroxobin (a snake venom enzyme insensitive to heparin that directly converts fibrinogen to fibrin) is substituted for thrombin.

Fibrin clot stability is tested by clotting 0.2 mL plasma with 0.2 mL calcium chloride and incubating one clot in 3 mL of NaCl solution and another clot in 3 mL of 5M urea for 24 h at 37° C (98.6° F). Lysis of the clot incubated in NaCl solution indicates excessive fibrinolysis. Lysis of the clot incubated in urea indicates factor XIII deficiency. A normal result does not rule out a milder yet potentially

clinically significant abnormality of fibrinolysis (eg, a reduced plasma α_2 -antiplasmin level in the 10 to 30% of normal range).

The **plasma protamine paracoagulation test** screens for soluble fibrin monomer in patients with suspected DIC. One-tenth volume of 1% protamine sulfate is mixed with plasma, which, after a brief incubation at 37° C (98.6° F), is examined for precipitated fibrin strands. A positive result supports the diagnosis of DIC, but a negative result does not rule it out. A false-positive result may be caused by difficulty with venipuncture or by inadequate anticoagulation of a blood sample.

Fibrin degradation products can be measured by two tests. In the D-dimer test, undiluted test plasma and diluted test plasma as necessary are mixed with latex particles coated with monoclonal antibodies that react exclusively with derivatives of fibrin that contain D-dimer, which are formed when plasmin degrades cross-linked fibrin. The mixtures are observed for agglutination of the latex particles. The antibodies will not react with fibrinogen itself, which is why the test can be performed on plasma, nor with fibrinogen degradation products because these are not cross-linked. Thus, the test is specific for fibrin degradation products. Undiluted

Hematology

plasma from healthy persons will test negative (< 0.25 $\mu\text{g/mL}$ of D-dimer). Normal serum may contain small amounts (< 10 $\mu\text{g/mL}$) of residual fibrin degradation products. Agglutination with a 1:20 dilution of serum indicates increased amounts (≥ 40 $\mu\text{g/mL}$) of fibrin degradation products.

A **euglobulin lysis time** is also often part of screening if increased fibrinolytic activity is suspected. Euglobulins are precipitated by dilution and acidification of plasma. The euglobulin fraction, which is relatively free of inhibitors of fibrinolysis, is clotted with thrombin, and the time for the clot to dissolve is measured. Normal lysis is > 90 min; a shorter time indicates increased plasma plasminogen activator activity (eg, in some patients with advanced liver disease). A reduced plasma fibrinogen concentration, by yielding a smaller clot to be dissolved, may also result in a shorter time.

Disorders of hemostasis

Excessive bleeding may occur as a result of an abnormality of blood vessels, platelets, or coagulation factors.

I. Vascular disorders

In vascular bleeding disorders, tests of hemostasis are

usually normal. The diagnosis is made from other clinical findings.

A. Von Willebrand's Disease

Von Willebrand's disease is a hereditary autosomal dominant disorder that usually results from decrease endothelial cell release or synthesis of vWF multimers. It is an autosomal dominant bleeding disorder resulting from a quantitative (types 1 and 3) or qualitative (type 2) abnormality of von Willebrand factor (VWF), a plasma protein secreted by endothelial cells that circulates in plasma in multimers of up to 20 million daltons. It affects both sexes.

VWF has two known hemostatic functions: (1) Very large VWF multimers are required for platelets to adhere normally to subendothelium at sites of vessel wall injury (2) Multimers of all sizes form complexes in plasma with factor VIII; formation of such complexes is required to maintain normal plasma factor VIII levels. Therefore, two hereditary disorders may cause factor VIII deficiency: hemophilia A, in which the factor VIII molecule is not synthesized in normal amounts or is synthesized abnormally, and VWD, in which the VWF molecule is not synthesized in normal amounts or is synthesized abnormally.

B. Purpura Simplex (Easy Bruising)

The most common vascular bleeding disorder, manifested by increased bruising and representing increased vascular fragility. Purpura simplex usually affects women. Bruises develop without known trauma on the thighs, buttocks, and upper arms. The platelet count and tests of platelet function, blood coagulation, and fibrinolysis are normal. No drug prevents the bruising; the patient is often advised to avoid aspirin and aspirin-containing drugs, but there is no evidence that bruising is related to their use. The patient should be reassured that the condition is not serious.

C. Senile Purpura

A disorder affecting older patients, particularly those who have had excessive sun exposure, in whom dark purple ecchymoses, characteristically confined to the extensor surfaces of the hands and forearms, persist for a long time.

New lesions appear without known trauma. Lesions slowly resolve over several days, leaving a brownish discoloration caused by deposits of hemosiderin; this discoloration may clear over weeks to months. The skin and subcutaneous tissue of the involved area often appear thinned and atrophic. Treatment does not hasten

lesion resolution and is not needed. Although cosmetically displeasing, the disorder has no serious consequences.

D. Hereditary Hemorrhagic Telangiectasia (Rendu-Osler-Weber Disease)

A hereditary disease of vascular malformation transmitted as an autosomal dominant trait affecting men and women. Diagnosis is made on physical examination by the discovery of characteristic small, red-to-violet telangiectatic lesions on the face, lips, oral and nasal mucosa, and tips of the fingers and toes. Similar lesions may be present throughout the mucosa of the GI tract, resulting in chronic, recurrent GI bleeding. Patients may experience recurrent, profuse nosebleeds. Some patients may have associated pulmonary arteriovenous fistulas.

These fistulas may produce significant right-to-left shunts, which can result in dyspnea, fatigue, cyanosis, or polycythemia. However, the first sign of their presence may be a brain abscess, transient ischemic attack, or stroke, as a result of infected or noninfected emboli. Cerebral or spinal arteriovenous malformations occur in some families and may cause subarachnoid hemorrhage, seizures, or paraplegia. When a family

history of pulmonary or cerebral arteriovenous malformations is present, screening at puberty and at the end of adolescence with pulmonary CT or cerebral MRI can be beneficial. Laboratory studies are usually normal except for evidence of iron-deficiency anemia in most patients.

E. Henoch-Schönlein Purpura(Allergic Or Anaphylactoid Purpura)

An acute or chronic vasculitis affecting primarily small vessels of the skin, joints, GI tract, and kidney. The disease primarily affects young children but may affect older children and adults. An acute respiratory infection precedes purpura in a high proportion of affected young children. Less commonly, a drug may be the inciting agent, and a drug history should always be obtained.

The serum often contains immune complexes with an IgA component. Biopsy of an acute skin lesion reveals an aseptic vasculitis with fibrinoid necrosis of vessel walls and perivascular cuffing of vessels with polymorphonuclear leukocytes. Granular deposits of immunoglobulin reactive for IgA and of complement components may be seen on immunofluorescent study. Therefore, deposition of IgA-containing immune complexes with consequent activation of complement is

Hematology

thought to represent the pathogenetic mechanism for the vasculitis. The typical renal lesion is a focal, segmental proliferative glomerulonephritis.

The disease begins with the sudden appearance of a purpuric skin rash that typically involves the extensor surfaces of the feet, legs, and arms and a strip across the buttocks. The purpuric lesions may start as small areas of urticaria that become indurated and palpable. Crops of new lesions may appear over days to several weeks. Most patients also have fever and polyarthralgia with associated periarticular tenderness and swelling of the ankles, knees, hips, wrists, and elbows. Many patients develop edema of the hands and feet. GI findings are common and include colicky abdominal pain, abdominal tenderness, and melena. Stool may test positive for occult blood. From 25 to 50% of patients develop hematuria and proteinuria. The disease usually remits after about 4 wk but often recurs at least once after a disease-free interval of several weeks. In most patients, the disorder subsides without serious sequelae; however, some patients develop chronic renal failure.

Diagnosis is based largely on recognition of clinical findings. Renal biopsy may help define the prognosis of

the renal lesion. The presence of diffuse glomerular involvement or of crescentic changes in most glomeruli predicts progressive renal failure.

F. Vascular Purpura Caused By Dysproteinemias

Hypergammaglobulinemic purpura is a syndrome that primarily affects women. It is characterized by a polyclonal increase in IgG (broad-based or diffuse hypergammaglobulinemia on serum protein electrophoresis) and recurrent crops of small, palpable purpuric lesions on the lower legs. These lesions leave small residual brown spots. Vasculitis is seen on biopsy. Many patients have manifestations of an underlying immunologic disorder (eg, Sjögren's syndrome, SLE).

Cryoglobulinemia is characterized by the presence of immunoglobulins that precipitate when plasma is cooled (ie, cryoglobulins) while flowing through the skin and subcutaneous tissues of the extremities. Monoclonal immunoglobulins formed in Waldenström's macroglobulinemia or in multiple myeloma occasionally behave as cryoglobulins, as may mixed IgM-IgG immune complexes formed in some chronic infectious diseases, most commonly in hepatitis C. Cryoglobulinemia can lead to small vessel damage and resultant purpura. Cryoglobulinemia can be recognized

after clotting blood at 37° C (98.6° F), incubating the separated serum at 4° C (39.2° F) for 24 h, and examining the serum for a gel or precipitate.

Hyperviscosity of blood resulting from a markedly elevated plasma IgM concentration may also result in purpura and other forms of abnormal bleeding (eg, profuse epistaxis) in patients with Waldenström's macroglobulinemia.

In **amyloidosis**, deposits of amyloid within vessels in the skin and subcutaneous tissues produce increased vascular fragility and purpura. Periorbital purpura or a purpuric rash that develops in a nonthrombocytopenic patient after gentle stroking of the skin should arouse suspicion of amyloidosis. In some patients a coagulation disorder develops, apparently the result of adsorption of factor X by amyloid.

G. Leukocytoclastic Vasculitis

A necrotizing vasculitis accompanied by extravasation and fragmentation of granulocytes. Causes include hypersensitivity to drugs, viral infections (eg, hepatitis), and collagen vascular disorders. The most common clinical manifestation is palpable purpura, often associated with systemic symptoms, such as polyarthralgia and fever. Diagnosis is established by skin

biopsy. Therapy is determined by the underlying cause of the vasculitis.

H. Autoerythrocyte Sensitization (Gardner-Diamond Syndrome)

An uncommon disorder of women, characterized by local pain and burning preceding painful ecchymoses that occur primarily on the extremities. Intradermal injection of 0.1 mL of autologous RBCs or RBC stroma may result in pain, swelling, and induration at the injection site. This suggests that escape of RBCs into the tissues is involved in the pathogenesis of the lesion. However, most patients also have associated severe psychoneurotic symptoms, and psychogenic factors, such as self-induced purpura, seem related to the pathogenesis of the syndrome in some patients.

II. Platelet disorders

Platelet disorders may cause defective formation of hemostatic plugs and bleeding because of decreased platelet numbers (thrombocytopenia) or because of decreased function despite adequate platelet numbers (platelet dysfunction).

A. Thrombocytopenia

Thrombocytopenia is quantity of platelets below the normal range of 140,000 to 440,000/ μ L.

Thrombocytopenia may stem from failed platelet production, splenic sequestration of platelets, increased platelet destruction or use, or dilution of platelets. Regardless of cause, severe thrombocytopenia results in a typical pattern of bleeding: multiple petechiae in the skin, often most evident on the lower legs; scattered small ecchymoses at sites of minor trauma; mucosal bleeding (epistaxis, bleeding in the GI and GU tracts, vaginal bleeding); and excessive bleeding after surgery. Heavy GI bleeding and bleeding into the CNS may be life threatening. However, thrombocytopenia does not cause massive bleeding into tissues (eg, deep visceral hematomas or hemarthroses), which is characteristic of bleeding secondary to coagulation disorders.

Idiopathic (immunologic) thrombocytopenic purpura

A hemorrhagic disorder not associated with a systemic disease, which is typically chronic in adults but is usually acute and self-limited in children.

Adult idiopathic thrombocytopenic purpura (ITP) usually results from development of an antibody directed

against a structural platelet antigen (an autoantibody). In childhood ITP, viral antigen is thought to trigger synthesis of antibody that may react with viral antigen associated with the platelet surface.

Other immunologic thrombocytopenias

Patients infected with HIV may present with clinical findings identical to ITP, except they test positive for HIV. These patients may respond to glucocorticoids, which are often not given unless the platelet count falls below 30,000/ μL because these drugs may further depress immune function. In most HIV patients, the thrombocytopenia responds to treatment with antiviral drugs.

Other disorders producing thrombocytopenia similar to ITP include **immune thrombocytopenias secondary to a collagen vascular disorder (eg, SLE) or to lymphoproliferative disease**. Corticosteroids and splenectomy are often effective in treating these forms of thrombocytopenia. The clinical findings in **posttransfusion purpura** are also similar to ITP, except for a recent history of a blood transfusion (within the preceding 7 to 10 days). The patient, usually a woman, lacks a platelet antigen (PLA-1) present in most people. PLA-1-positive platelets in transfused blood stimulate

formation of anti-PLA-1 antibodies, which (by an unknown mechanism) can react with the patient's PLA-1-negative platelets. Severe thrombocytopenia results, taking 2 to 6 wk to subside. Some **drug-related immune thrombocytopenias** (eg, quinidine- and quinine-induced thrombocytopenia) also have clinical findings identical to ITP, except for the history of drug ingestion. When the drug is stopped, the platelet count begins to increase within 1 to 7 days. However, gold-induced thrombocytopenia is an exception because injected gold salts may persist in the body for many weeks.

Heparin-Induced Thrombocytopenia

Heparin-induced thrombocytopenia, the most important thrombocytopenia resulting from drug-related antibodies, occurs in up to 5% of patients receiving bovine heparin and in 1% of those receiving porcine heparin. Rarely, patients with heparin-induced thrombocytopenia develop life-threatening arterial thromboses (eg, thromboembolic occlusion of limb arteries, strokes, acute MI).

The thrombocytopenia results from the binding of heparin-antibody complexes to Fc receptors on the platelet surface membrane. Platelet factor 4, a cationic and strongly heparin-binding protein secreted from

platelet alpha granules, may localize heparin on platelet and endothelial cell surfaces. In addition, platelet factor 4-heparin complexes are the principal antigens. Platelet clumps can form, causing vessel obstruction.

Heparin should be stopped in any patient who becomes thrombocytopenic. Because clinical trials have demonstrated that 5 days of heparin therapy are sufficient to treat venous thrombosis and because most patients begin oral anticoagulants simultaneously with heparin, heparin can usually be stopped safely. Laboratory assays do not aid these clinical decisions.

Nonimmunologic thrombocytopenia

Thrombocytopenia secondary to platelet sequestration can occur in various disorders that produce splenomegaly. It is an expected finding in patients with congestive splenomegaly caused by advanced cirrhosis. In contrast to immunologic thrombocytopenias, the platelet count usually does not fall below about 30,000/ μL unless the disorder producing the splenomegaly also impairs the marrow production of platelets (eg, in myelofibrosis with myeloid metaplasia). Therefore, thrombocytopenia caused by splenic sequestration is usually of no clinical importance. In addition, functional platelets are released from the spleen by an epinephrine

infusion and therefore may be available at a time of stress. Splenectomy will correct the thrombocytopenia, but it is not indicated unless repeated platelet transfusions are required.

Patients with **gram-negative sepsis** often develop thrombocytopenia. Its severity often parallels that of the infection. The thrombocytopenia has multiple causes: disseminated intravascular coagulation, formation of immune complexes that can associate with platelets, activation of complement, and deposition of platelets on damaged endothelial surfaces.

Patients with **adult respiratory distress syndrome** also may become thrombocytopenic, possibly secondary to deposition of platelets in the pulmonary capillary bed.

Thrombotic thrombocytopenic purpura-hemolytic-uremic syndrome

Acute, severe disorders in which loose strands of fibrin are deposited in multiple small vessels, which damage passing platelets and RBCs, resulting in thrombocytopenia and microangiopathic hemolytic anemia.

Platelet consumption within multiple small thrombi also

contributes to the thrombocytopenia. Although thrombotic thrombocytopenic purpura (TTP) and hemolytic-uremic syndrome (HUS) are often thought to be distinct, the difference is only in the relative degree of renal failure. Diagnosis and management are the same.

B. Platelet Dysfunction

In some disorders, the platelets may be normal in number, yet hemostatic plugs do not form normally and the bleeding time will be long. Platelet dysfunction may stem from an intrinsic platelet defect or from an extrinsic factor that alters the function of otherwise normal platelets. Defects may be hereditary or acquired. Tests of the coagulation phase of hemostasis (eg, partial thromboplastin time and prothrombin time) are normal in most circumstances but not all (see Von Willebrand's Disease,).

Hereditary disorders of platelet function

The most common hereditary intrinsic platelet disorders are a group of mild bleeding disorders that may be considered **disorders of amplification of platelet activation**. They may result from decreased adenosine diphosphate (ADP) in the platelet-dense granules (storage pool deficiency), from an inability to generate

thromboxane A_2 from arachidonic acid released from the membrane phospholipids of stimulated platelets, or from an inability of platelets to respond normally to thromboxane A_2 . They present with a common pattern of platelet aggregation test results: (1) impaired-to-absent aggregation after exposure to collagen, epinephrine, and a low concentration of ADP and (2) normal aggregation after exposure to a high concentration of ADP. Aspirin and other NSAIDs may produce the same pattern of platelet aggregation test results in healthy persons. Because aspirin's effect can persist for several days, it must be confirmed that a patient has not taken aspirin for several days before testing to avoid confusion with a hereditary platelet defect.

Thrombasthenia is a rare hereditary platelet defect that affects platelet surface membrane glycoproteins. It is an autosomal recessive disorder. Consanguinity is common in affected families. Thrombasthenia patients may have severe mucosal bleeding (eg, nosebleeds that stop only after nasal packing and transfusions of platelet concentrates). Their platelets, lacking the membrane glycoprotein GP IIb-IIIa, fail to bind fibrinogen during platelet activation and thus fail to aggregate. Typical laboratory findings are failure of platelets to aggregate with any physiologic aggregating agent, including a high

concentration of exogenous ADP; absence of clot retraction; and single platelets without aggregates on a peripheral blood smear of capillary blood obtained from a finger stick.

Bernard-Soulier syndrome is another rare autosomal recessive disorder that affects surface membrane glycoproteins. Unusually large platelets are present that do not agglutinate with ristocetin but aggregate normally with the physiologic aggregating agents ADP, collagen, and epinephrine. A surface membrane glycoprotein (GP Ib-IX) that contains a receptor for VWF is missing from the platelet surface membrane in this disorder. Therefore, the platelets do not adhere normally to subendothelium despite normal VWF levels in plasma.

Large platelets associated with functional abnormalities also may be found in the **May-Hegglin anomaly**, a thrombocytopenic disorder with abnormal WBCs, and in the **Chédiak-Higashi syndrome**.

Serious bleeding in a patient with an intrinsic platelet disorder may require platelet transfusion.

Acquired platelet dysfunction

Acquired abnormalities of platelet function are very common because use of aspirin, which predictably affects platelet function, is ubiquitous. Many other drugs

Hematology

may also induce platelet dysfunction. Many clinical disorders (eg, myeloproliferative and myelodysplastic disorders, uremia, macroglobulinemia and multiple myeloma, cirrhosis, SLE) can affect platelet function as well.

Aspirin, which modestly prolongs the bleeding time in many healthy persons, may markedly increase the bleeding time in patients with an underlying platelet dysfunction or who have a severe coagulation disturbance (eg, patients who have been given therapeutic heparin or those with severe hemophilia).

Platelets may become dysfunctional, prolonging the bleeding time, as blood circulates through a pump oxygenator during cardiopulmonary bypass surgery.

Thus, regardless of platelet numbers, patients who bleed excessively after cardiac surgery and who have a long bleeding time should be given platelet concentrates. The platelet dysfunction appears to stem primarily from activation of fibrinolysis on the platelet surface, with resultant loss from the platelet membrane of the GP Ib binding site for VWF. During bypass surgery, giving aprotinin (a protease inhibitor that neutralizes plasmin activity) reportedly prevents prolongation of the bleeding time and reduces the need for blood replacement.

Patients with uremia caused by chronic renal failure may have a long bleeding time for unknown reasons. The bleeding time may shorten transiently after vigorous dialysis, administration of cryoprecipitate, or desmopressin infusion. Raising the RBC count by transfusion or by giving erythropoietin also causes the bleeding time to shorten.

III. Coagulation disorders

Decreased or defective synthesis of one or more of the coagulation factors can cause bleeding. In disorders other than vWD, the defect is probable within hepatic cells. A single factor is deficient in all inherited coagulopathies except the rare combined deficiency of factor VIII and factor V. In contrast, several coagulation factors are deficient in most acquired disorders.

A. Hereditary Coagulation Disorders

Common forms of hereditary bleeding disorders are caused by clotting factor deficiencies of factor VIII, IX, or XI. Hemophilia A (factor VIII deficiency), which affects about 80% of hemophiliacs, and hemophilia B (factor IX deficiency) have identical clinical manifestations, screening test abnormalities, and X-linked genetic

Hematology

transmission. Specific factor assays are required to distinguish the two.

Hemophilia may result from gene mutations: point mutations involving a single nucleotide, deletions of all or parts of the gene, and mutations affecting gene regulation. About 50% of cases of severe hemophilia A result from a major inversion of a section of the tip of the long arm of the X chromosome. Because factor VIII and factor IX genes are located on the X chromosome, hemophilia affects males almost exclusively. Daughters of hemophiliacs will be obligatory carriers, but sons will be normal. Each son of a carrier has a 50% chance of being a hemophiliac, and each daughter has a 50% chance of being a carrier. Rarely, random inactivation of one of the two X chromosomes in early embryonic life will result in a carrier's having a low enough factor VIII or IX level to experience abnormal bleeding.

A patient with a factor VIII or IX level $< 1\%$ of normal has severe bleeding episodes throughout life. The first episode usually occurs before age 18 mo. Minor trauma can result in extensive tissue hemorrhages and hemarthroses, which, if improperly managed, can result in crippling musculoskeletal deformities. Bleeding into the base of the tongue, causing airway compression,

Hematology

may be life threatening and requires prompt, vigorous replacement therapy. Even a trivial blow to the head requires replacement therapy to prevent intracranial bleeding.

Patients with factor VIII or IX levels about 5% of normal have mild hemophilia. They rarely have spontaneous hemorrhages; however, they will bleed severely (even fatally) after surgery if not managed correctly. Occasional patients have even milder hemophilia with a factor VIII or IX level in the 10 to 30% of normal range. Such patients may also bleed excessively after surgery or dental extraction.

Laboratory Findings

By measuring the factor VIII level and comparing it with the level of VWF antigen, it is often possible to determine whether a female is a true carrier of hemophilia A. Similarly, measuring the factor IX level often identifies a carrier of hemophilia B. Polymerase chain reaction analysis of DNA in the factor VIII gene amplified from lymphocytes is available at a few specialized centers. This test allows identification of the hemophilia A carrier, either directly by recognition of a known specific genomic defect in the pedigree, or indirectly through study of restriction fragment length

Hematology

polymorphisms linked to the factor VIII gene. These techniques have also been applied to the diagnosis of hemophilia A by chorionic villus sampling in the 8- to 11-wk fetus.

Typical findings in hemophilia are a prolonged PTT, a normal PT, and a normal bleeding time. Factor VIII and IX assays determine the type and severity of the hemophilia. Because factor VIII levels may also be reduced in VWD, VWF antigen should be measured in patients with newly diagnosed hemophilia A, particularly if the disease is mild and a family history cannot be obtained. Some patients have an abnormal VWF that binds abnormally to factor VIII, which in turn is catabolized more rapidly (VWD, type 2N).

After transfusion therapy, about 15% of patients with hemophilia A develop factor VIII antibodies that inhibit the coagulant activity of further factor VIII given to the patient. Patients should be screened for factor VIII anticoagulant activity (eg, by measuring the degree of PTT shortening immediately after mixing the patient's plasma with equal parts of normal plasma and after incubation for 1 h at room temperature), especially before an elective procedure that requires replacement therapy.

B. Acquired Coagulation Disorders

The major causes of acquired coagulation disorders are vitamin K deficiency, liver disease, disseminated intravascular coagulation, and development of circulating anticoagulants.

Liver disease-related coagulation disorders

Liver disease may disturb hemostasis by impairing clotting factor synthesis, increasing fibrinolysis, or causing thrombocytopenia. In patients with fulminant hepatitis or acute fatty liver of pregnancy, hemostasis is disturbed through decreased production and consumption of clotting factors in intravascular clotting.

Disseminated intravascular coagulation

(Abnormal generation of fibrin in the circulating blood.)

Disseminated intravascular coagulation (DIC) usually results from entrance into or generation within the blood of material with tissue factor activity, initiating coagulation. DIC usually arises in one of four clinical circumstances: (1) Complications of obstetrics--eg, abruptio placentae, saline-induced therapeutic abortion, retained dead fetus syndrome, the initial phase of amniotic fluid embolism. Uterine material with tissue factor activity gains access to the maternal circulation. (2) Infection, particularly with gram-negative organisms.

Gram-negative endotoxin causes generation of tissue factor activity on the plasma membrane of monocytes and endothelial cells. (3) Malignancy, particularly mucin-secreting adenocarcinomas of the pancreas and prostate and acute promyelocytic leukemia, in which hypergranular leukemic cells are thought to release material from their granules with tissue factor activity. (4) Shock from any cause, probably because of the generation of tissue factor activity on monocytes and endothelial cells.

Less common causes of DIC include severe head trauma that breaks down the blood-brain barrier and allows exposure of blood to brain tissue with potent tissue factor activity; complications of prostatic surgery that allow prostatic material with tissue factor activity to enter the circulation; and venomous snake bites in which enzymes that activate factor X or prothrombin or that directly convert fibrinogen to fibrin enter the circulation.

Symptoms and Signs

Subacute DIC may be associated with thromboembolic complications of hypercoagulability, including venous thrombosis, thrombotic vegetations on the aortic heart valve, and arterial emboli arising from such vegetations. Abnormal bleeding is uncommon.

In contrast, thrombocytopenia and depletion of plasma clotting factors of **acute, massive DIC** create a severe bleeding tendency that is worsened by secondary fibrinolysis; ie, large amounts of fibrin degradation products form and interfere with platelet function and normal fibrin polymerization. If secondary fibrinolysis is extensive enough to deplete plasma α_2 -antiplasmin, a loss of control of fibrinolysis adds to the bleeding tendency. When massive DIC is a complication of delivery or surgery that leaves raw surfaces (eg, prostatectomy), major hemorrhage results: Puncture sites of invasive procedures (eg, arterial puncture for blood gas studies) bleed persistently, ecchymoses form at sites of parenteral injections, and serious GI bleeding may occur from erosion of gastric mucosa.

Acute DIC may also cause fibrin deposition in multiple small blood vessels. If secondary fibrinolysis fails to lyse the fibrin rapidly, hemorrhagic tissue necrosis may result. The most vulnerable organ is the kidney, where fibrin deposition in the glomerular capillary bed may lead to acute renal failure. This is reversible if the necrosis is limited to the renal tubules (acute renal tubular necrosis) but irreversible if the glomeruli are also destroyed (renal cortical necrosis). Fibrin deposits may also result in mechanical damage to RBCs with hemolysis.

Occasionally, fibrin deposited in the small vessels of the fingers and toes leads to gangrene and loss of digits and even arms and legs.

Laboratory Findings

Laboratory findings vary with the intensity of the disorder. In **subacute DIC**, the findings are thrombocytopenia, a normal to minimally prolonged prothrombin time (PT), a short partial thromboplastin time (PTT), a normal or moderately reduced fibrinogen level, and an increased level of fibrin degradation products. (Because illness stimulates increased fibrinogen synthesis, a fibrinogen level in the lower range of normal [eg, 175 mg/dL] is abnormal in a sick patient and raises the possibility of impaired production resulting from liver disease or increased consumption from DIC.)

Acute, massive DIC produces a striking constellation of laboratory abnormalities: thrombocytopenia; a very small clot (sometimes not even visible), noted when blood is allowed to clot in a glass tube; a markedly prolonged PT and PTT (the plasma contains insufficient fibrinogen to trigger the end point of coagulation instruments, and test results are often reported as more than some value [eg, > 200 sec], which is the interval before the automated

instrument shifts to the next sample in the machine); a markedly reduced plasma fibrinogen concentration; a positive plasma protamine paracoagulation test for fibrin monomer; and a very high level of plasma D-dimer and fibrin degradation products in the serum. Specific clotting factor assays will reveal low levels of multiple clotting factors, particularly factors V and VIII, which are inactivated because activated protein C is generated during DIC.

Massive hepatic necrosis can produce laboratory abnormalities resembling acute DIC. The factor VIII level is elevated in hepatic necrosis because factor VIII is an acute-phase protein that is made in hepatocytes and in cells in the spleen and kidney; it is reduced in DIC.

Coagulation disorders caused by circulating anticoagulants

Circulating anticoagulants are endogenous substances that inhibit blood coagulation. These substances are usually antibodies that neutralize the activity of a clotting factor (eg, an antibody against factor VIII or factor V) or the activity of the procoagulant phospholipid.

Occasionally, antibodies cause bleeding by binding prothrombin, not by neutralizing clotting factor activity. Although the prothrombin-antiprothrombin complex

retains its coagulant activity in vitro, it is rapidly cleared from the blood in vivo, resulting in acute hypoprothrombinemia. A similar mechanism may result in low levels of factor X, factor VII, or von Willebrand factor. Rarely, circulating anticoagulants are glycosaminoglycans with heparin-like anticoagulant activity arising from their ability to increase antithrombin III reactivity. These heparin-like anticoagulants are found mainly in patients with multiple myeloma or other hematologic malignancies.

Factor VIII Anticoagulants

Plasma containing a factor VIII antibody will show the same coagulation test abnormalities as plasma from a patient with hemophilia A, except that adding normal plasma or another source of factor VIII to the patient's plasma will not correct the abnormality.

Antibodies to factor VIII develop in about 20 to 25% of patients with severe hemophilia A as a complication of replacement therapy, because transfused factor VIII is a foreign, immunogenic agent. Factor VIII antibodies also arise in nonhemophilic patients: occasionally in a postpartum woman, as a manifestation of underlying systemic autoimmune disease or of a hypersensitivity reaction to a drug, or as an isolated phenomenon

without evidence of other underlying disease. Patients with a factor VIII anticoagulant are at risk of life-threatening hemorrhage.

Therapy with cyclophosphamide and corticosteroids has suppressed antibody production in some nonhemophiliacs. Immunosuppression should be attempted in all nonhemophiliacs, with the possible exception of the postpartum woman, whose antibodies may disappear spontaneously. Because immunosuppressants do not seem to influence antibody production in hemophiliacs, they are not recommended. Other facets of management are discussed above.

Circulating Anticoagulants

A common anticoagulant first described in patients with SLE was logically called the **lupus anticoagulant**; it was later recognized in patients with a variety of disorders, often as an unrelated finding.

Although the anticoagulant interferes with the function of procoagulant phospholipid in clotting tests in vitro, patients with only the lupus anticoagulant do not bleed excessively. Paradoxically, for an unknown reason, patients with the lupus anticoagulant are at increased risk for thrombosis, which may be either venous or arterial. Repeated first-trimester abortions, possibly

related to thrombosis of placental vessels, have also been reported. If such a patient experiences a thrombotic episode, long-term prophylaxis with anticoagulant therapy is usually advised.

A subset of patients with the lupus anticoagulant develop a second antibody--the non-neutralizing antibody to prothrombin that induces hypoprothrombinemia. These patients bleed abnormally. Hypoprothrombinemia is suspected when the screening tests reveal a long PT and PTT and is confirmed by a specific assay. Treatment with corticosteroids is indicated; usually the PT returns rapidly to normal and bleeding is controlled.

The phenomenon of in vitro anticoagulation results when antibodies react with anionic phospholipids (including the phospholipids used in the PTT and in specific clotting factor assays based on the PTT technique); these antibodies do not react with pure phospholipids but with epitopes on protein that complex with phospholipids.

Anticardiolipin antibodies bind to β_2 -glycoprotein I. The lupus anticoagulant binds to prothrombin. Evidence also suggests that these antibodies may bind to protein C, S, and other antigens.

The lupus anticoagulant is frequently detected by an isolated prolongation of the PTT that fails to correct with a 1:1 mixture of the patient's plasma and normal plasma. The PT is either normal or minimally prolonged, and there is frequently a nonspecific depression of clotting factors measured by PTT (factors VIII, IX, XI, and XII). A variety of more sensitive tests use a dilute phospholipid system, including the dilute Russell's viper venom time, kaolin clotting time, dilute phospholipid PTT, and dilute tissue thromboplastin inhibition time. The specificity of the test for the lupus anticoagulant is increased by correction of a prolonged clotting time by phospholipids (particularly hexagonal phospholipid).

Anticardiolipin antibodies are detected by an enzyme-linked immunosorbent assay.

LABORATORY ASPECTS OF THE BLEEDING DISORDERS

I. The Bleeding Time Test

Principle

The bleeding time is a measure of vascular and platelet integrity. It is measured by determining the time required for bleeding to stop from small subcutaneous vessels that have been severed by a standardized incision.

Three generations of tests have been developed each with increasing standardization of a wound of uniform depth and length.

A. The Duke Method

This is the oldest method which is performed by puncturing the earlobe with a lancet. The method is no more recommended today owing to the following drawbacks:

- It is not possible to standardize the depth of the wound
- If the patient has a significant bleeding disorder, bleeding into the soft subcutaneous tissue in the earlobe could lead to a large hematoma.

B. The Ivy Method

Principle

Three incisions are made on the volar side of the arm using a lancet known as a Stylet that has a shoulder to limit the depth of the cut. The bleeding times of the three wounds are averaged.

Advantages

- Standardized incision
- Improved standardization of the pressure in the

Hematology

vascular system because a sphygmomanometer cuff around the upper arm maintains venous pressure within narrow limits.

Equipment

- Sphygmomanometer
- Stop watches
- Circular filter paper
- 70% alcohol
- Cotton wool pads or gauze
- Disposable stylets (with 2mm pointed blades)
- Sterile bandages

Procedure

1. Apply the manometer cuff around the upper arm; gently cleanse the forearm with an alcohol pad allow to dry.
2. Inflate the cuff to 40mmHg. Maintain this pressure throughout the test.
3. Make three cuts on the lower arm, preferably on the anterior side where there is no hair; avoid superficial veins.
4. Start one stop watch for each puncture wound when bleeding begins; in general bleeding starts within 30 seconds, if not, spread the wounds slightly between two fingers (this does not change the result).

Hematology

5. Gently blot the blood with a circular filter paper at 15 second intervals; avoid direct contact of the filter paper with the wound as this may remove the platelet plug and aggravate bleeding.
6. The endpoint is reached when blood no longer stains the filter paper. Record the time at this point for each puncture wound. Average the bleeding times of the three wounds.
7. Clean the puncture sites and apply a sterile bandage.

Normal Values

Children: < 8 minute

Adults: < 6 minutes

*Each laboratory should establish its own normal range which will depend on whether a lateral or longitudinal incision is made and precise determination of the end point.

Sources of Error

- No bleeding occurs because of too gentle an incision.
- Severe (prolonged) bleeding indicates that a superficial vein has probably been cut.
- If the filter paper touches the wound, a platelet

plug may be removed, resulting in prolonged bleeding.

C. The Template Method

Principle: the same as Ivy's.

Materials

- Template, blade handle and gauge
- Surgical blade (no.11)
- Stop watches
- Circular filter paper
- 70% alcohol
- Cotton wool pads or gauze
- Sterile bandages

Procedure

1. Mount the surgical blade on the handle. Standardize the depth of the blade by placing the handle on the gauge. Adjust the blade so that the tip just touches the foot of the gauge. Be sure to keep the blade sterile while handling it. Tighten the screw holding the blade.
2. Apply the cuff on the upper arm; gently cleanse the forearm with an alcohol pad and allow to dry.
3. Inflate the cuff to 40mmHg. Maintain this pressure throughout the test.

Hematology

4. Place the template on the forearm about 5cm from the antecubital fossa.
5. Apply firm pressure to the template while introducing the blade at a right angle on the upper portion of the template slot. This guides the blade to make an incision that is 1mm deep and 9mm long. Make the incision smoothly and rapidly. Start the stop watch immediately. Make a second (or third) incision parallel to the first and start separate stop watches. Under normal conditions the first full drop of blood appears in between 15 and 20 seconds.
6. Gently blot the blood with a circular filter paper at 30 second intervals.
7. The end point is reached when blood no longer stains the filter paper. Record the time at this point for each wound. Average the bleeding times of the two (or three) incisions.
8. Clean the wounds and apply a bandage or adhesive strip.
9. After the test, the template and gauge must be washed thoroughly with surgical soap then rinsed well with water and autoclaved or sterilized by a gas such as ethylene chloride.

Normal Value: 2-7 minutes with 9mm length incision.

Sources of Error

- Too much pressure on the template will permit too deep incision resulting in an erroneously prolonged time; too little pressure results in the reverse.
- Severe bleeding indicates that a superficial vein has probably been cut.
- If the filter paper touches the wound, a platelet aggregate might be removed resulting in prolonged bleeding.

Interpretation

Prolonged bleeding times are demonstrable in patients with:

- Thrombocytopenia with a platelet count of $< 50 \times 10^9/l$.
*The bleeding time should not be done in a thrombocytopenic patient particularly if it is known or suspected that the platelet count is $< 10 \times 10^9/l$ (bleeding time in such patients is nearly infinite).
- Acquired platelet function abnormalities, e.g., thrombocythemia, disseminated intravascular coagulation.
- Thrombasthenia

- Congenital thrombocytopathia, e.g., storage pool disease
- Congenital afibrinogenemia (there is mild prolongation of the bleeding time)

II. Whole Blood Coagulation Time

Method of Lee and White

Principle: Whole blood is delivered using carefully controlled venipuncture and collection process into standardized glass tubes. The clotting time of the blood is recorded and expressed in minutes. It is prolonged in defects of intrinsic and extrinsic coagulation and in the presence of certain pathological anticoagulants and heparin.

Procedure

1. Venous blood is withdrawn using normal precautions and a stop watch is started the moment blood appears in the syringe.
2. Deliver 1ml of blood into each of four 10 x 1cm dry, chemically clean glass tubes which have previously been placed in a water bath maintained at 37°C.
3. After 3 minutes have elapsed, keeping the tubes out of the water bath for as short time as possible, tilt them individually every 30 seconds. Avoid

unnecessary agitation since this may prolong the clotting time.

4. The clotting time is taken when the tube can be inverted without its contents spilling. The clotting time of each tube is recorded separately and the coagulation time is reported as an average of the four tubes.

Normal Range: 4-10 minutes

III. Clot Retraction: Classic Method

Principle: Clot retraction is a measure of: (1) the amount of fibrin formed and its subsequent contraction, (2) the number and quality of platelets, since platelets have a protein that causes clot retraction. Since the fibrin clot enmeshes the cellular elements of the blood, a limit is set to the extent fibrin contracts by the volume of red blood cells (the hematocrit). Hence, the lower the hematocrit, the greater the degree of clot retraction. Clot retraction is directly proportional to the number of platelets and inversely proportional to the hematocrit.

Procedure

1. Place 5ml of venous blood into an unscratched graduated centrifuge tube. Insert a coiled wire in the

Hematology

- bottom of the tube (1mm thick wire with a 3cm coil).
2. Place at 37°C for 1 hour after clotting has occurred.
 3. Gently lift the wire and allow the attached clot to drain for 1 or 2 minutes.
 4. Read the volume of fluid remaining in the tube. Express this volume as a percentage of the original volume of whole blood placed in the tube. If clot retraction is normal, approximately half of the original total volume of serum should remain.

Normal Values: 48-64% (average 55%)

Observation of the Clot

Examination of a clot in a tube gives information on:

- The concentration of fibrinogen
- The number and function of platelets, and
- The activity of the fibrinolytic system

Result

1. Normal: approximately 30% of the total volume in tube should be clot.
2. Thrombocytopenia, thrombasthenia: a very large clot with a weak structure.

3. Low fibrinogen concentration: small clot with a regular shape.
4. Enhanced fibrinolysis: a small irregular clot.
5. Complete afibrinogenemia (congenital) or severe

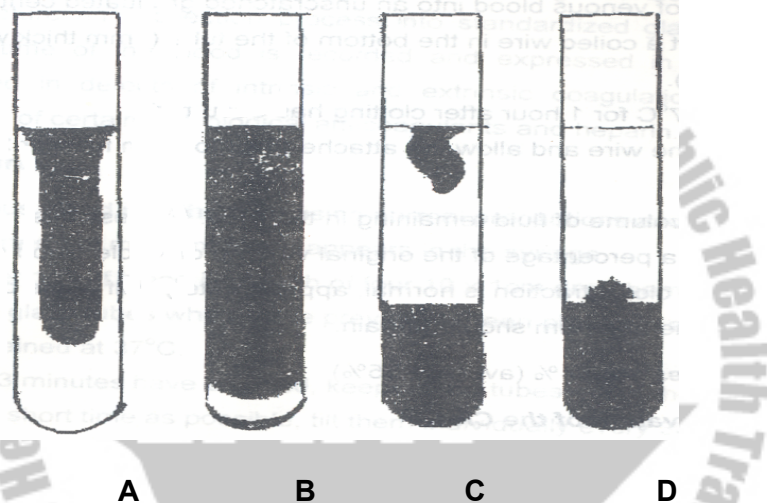

Fig. 20.1 Examples of clots found in normal persons and in patients with some coagulation abnormalities. A-Normal; B-Thrombocytopenia; C-Low fibrinogen; D-enhanced fibrinolysis

IV. Measurement of the Extrinsic System

Prothrombin Time (One stage)

Principle: The prothrombin is the time required for plasma to clot after tissue thromboplastin and an optimal amount of calcium chloride have been added. The test depends upon the activity of the factors VII, V, X, II, and I.

Equipment

Water bath, thermostat set at 37°C

Wire hook

Round bottom glass tubes

Stop watch

Reagents

Platelet poor citrated plasma

Thromboplastin - calcium reagent (commercial)

Procedure

1. Add blood to 32g/l sodium citrate in a ratio of nine parts of blood to one part citrate. Centrifuge the blood at 3000 rpm for 15 minutes to obtain platelet poor plasma. Incubate the plasma at 37°C for 5 minutes. To a test tube containing 0.2ml prewarmed thromboplastin - calcium, add 0.1ml prewarmed plasma. Start the stop watch.
2. Record the time required for clot formation by pulling the wire hook up and down every second. The end point is identified by the formation of a fibrin strand attached to the wire hook. The test sample should always be run along with a control plasma.

*If duplicate tests are done, the difference in duplicates of all samples must be less than 5% of the prothrombin time.

Normal Value: 11-16 seconds

Interpretation

The prothrombin time is prolonged in patients:

- With deficiency of one or more of the following factors: I, II, V, or X seen in patients with a circulating anticoagulant, vitamin K deficiency, intestinal malabsorption, liver disease or obstructive jaundice.
- On oral anticoagulant therapy.

V. Measurement of the Intrinsic System

Partial Thromboplastin Time (PTT)

Principle: Equal volumes of platelet poor plasma (PPP), partial thromboplastin and CaCl_2 are reacted at 37°C and the time taken for fibrin formation is the PTT.

Reagents

Control PPP, patient's PPP, partial thromboplastin (e.g., cephalin) and 0.025mol/l CaCl_2 .

Procedure

1. Prewarm sufficient partial thromboplastin and CaCl_2 solution in separate tubes in a water bath at 37°C .
2. Pipet 0.2ml of plasma into a 75 x 10mm glass tube and warm for 2 minutes.
3. Add 0.1ml partial thromboplastin followed by 0.1ml of CaCl_2 and start a stop watch. Briefly mix and allow to stand for about 40 seconds undisturbed in the water bath, then remove from the bath and tilt back and forth until fibrin clot forms. Stop the watch.
4. The test is repeated with both control and test plasmas; the duplicate times should be within 5 seconds. The average time is the PTT.

Normal Range

It is largely dependent on the activity of the partial thromboplastin but should be in the order of 45-70 seconds. Each laboratory should determine its own normal range using a series of plasmas from healthy subjects.

Interpretation

The PTT may be expected to be prolonged by:

- Defects in the intrinsic system - factors VIII, IX, XI,

XII and other contact factors.

- Defects in the 'common' coagulation pathway - factors X, V and I.
- Inhibitors to specific factors
- High levels of fibrin degradation

The Activated Partial Thromboplastin Time (APTT)

This is a development of the PTT in that the variable of contact activation is eliminated by the addition of an activator to obtain full contact activation and hence shortening of the PTT and narrowing of the normal range.

Principle

The test measures the intrinsic procoagulant activity of plasma. The partial thromboplastin is a substitute for platelet factor 3. contact activation is standardized by adding an activator (kaolin, celite or ellagic acid) to the reagent.

Equipment

- A water bath with thermostat and tube rack
- Round bottom glass test tubes
- Stopwatch
- A wire hook

Reagents

- Citrated PPP (spun at 300rpm for 15 minutes)
- 3.8% inosithin (a substitute for partial thromboplastin)
- Veronal buffer (pH 7.3)
- 2% celite suspension
- 0.025 mol/l CaCl_2
- Freshly drawn normal control plasma

Procedure

1. Prepare the APTT reagent the day of testing by adding 3.4ml of veronal buffer to 3.5ml of celite suspension and 0.1ml of 3.8% inosithin. Mix well.
2. In a test tube at 37°C, add 0.1ml plasma to 0.1ml well mixed APTT reagent. Start the stop watch and swirl to mix.
3. Incubate at 37°C for exactly 4 minutes. Swirl again.
4. Add 0.1ml prewarmed 0.025mol/l CaCl_2 . Swirl again and start stop watch.
5. Record the time required for clot formation while pulling the wire hook up and down each second.
6. Each patient and control plasma must be tested in duplicate.

Results

As with the PTT this is dependent upon the source of the partial thromboplastin in addition to the activator used and the activation time. It is generally in the order of 30-42 seconds. Each laboratory should determine its own normal range with the reagent in use and the selected activation period.



Review Questions

1. Define hemostasis.
2. What are the components of normal hemostasis?
3. How do the components of normal hemostasis integrate to maintain blood flow within the vascular system? Briefly elaborate.
4. How is the clotting process limited physiologically in normal hemostasis?
5. Write the principle and result interpretation of the following tests of the bleeding disorders:
 - Bleeding time test
 - Whole blood coagulation time test
 - Clot retraction test
 - Prothrombin time test (one stage)
 - Partial thromboplastin time test
 - Activated partial thromboplastin time test

CHAPTER TWENTY ONE

BODY FLUIDS ANALYSIS

Learning objectives

At the end of this chapter, the student shall be able to:

- Identify the different types of body fluids
- Explain the analysis of cerebrospinal fluid
- Describe the analysis of serous fluid
- Describe the analysis of synovial fluid
- Describe the analysis of semen

Introduction

Fluids such as cerebrospinal, serous (pleural, pericardial, peritoneal/ascitic), gastric, nasal, synovial, seminal, sweat, saliva, tears, vitreous, humor, and amniotic are examples of body fluid specimens, other than blood, that can be analyzed by the medical laboratory. Laboratory testing of these miscellaneous body fluids is usually done to aid in the diagnosis of specific conditions of disease. Depending of the nature of the tests to be done, various divisions of the laboratory are involved in handling the specimens.

Since cell counts are usually done in the hematology laboratory, the entire specimen can often first be sent to this laboratory section. From there it is sent to microbiology, chemistry, or to other specialized testing areas, as needed.

21.1 CEREBROSPINAL FLUID ANALYSIS

Cerebrospinal fluid (CSF) is found in the space known as the subarachnoid space between the arachnoid mater and the pia mater - two of the three membranes comprising the meninges covering the brain and spinal cord (From the outside in the dura mater, the arachnoid mater, and the pia mater). The CSF is made continuously by small masses of blood vessels which line the ventricles of the brain. An adult person produces 450-750ml of the fluid daily. From these, 120-150ml of the fluid is required to fill the arachnoid space between the brain and the spinal cord. The CSF is reabsorbed by the small blood vessels in the arachnoid called the arachnoid villi. The CSF has composition similar to the plasma with the exception that it contains less protein, less glucose and more chloride ions.

Hematology

Cerebrospinal fluid serves to protect the underlying tissue of the central nervous system. It acts as a mechanical buffer to prevent trauma, to regulate the volume of intracranial pressure, to circulate nutrients, to remove metabolic waste products from the central nervous system, and to generally act as a lubricant for the system.

Collection of CSF

Cerebrospinal fluid is normally collected by lumbar puncture (spinal tap) in one of the spaces between the third, fourth, or fifth lumbar vertebrae, depending on the age of the patient. The puncture is done in this location to avoid damage to the spinal cord. The most important indication for doing the lumbar puncture is to diagnose meningitis of bacterial, fungal, mycobacterial, and amebic origin.

In practice, three sterile tubes containing about 5ml each are collected during spinal tap. These tubes are numbered in sequence of collection and immediately brought to the laboratory. The tubes that are sequentially collected and labeled in order of collection are generally dispersed and utilized for analysis (after gross examination of all tubes) as follows:

Hematology

1. Tube 1: Chemical and immunologic tests
2. Tube 2: Microbiology
3. Tube 3: Total cell counts and differential cell counts. This is least likely to contain cells introduced by the puncture procedure itself.

Routine examination of CSF

Gross Appearance

All tubes collected by lumbar puncture are evaluated as to gross appearance. Normal spinal fluid is crystal clear. It looks like distilled water. Color and clarity are noted by holding the sample beside a tube of water against a clean white paper or a printed page.

Turbidity

Slight haziness in the specimen indicates a white cell count of 200 to 500/ μl , and turbidity indicates a white cell count of over 500/ μl . Turbidity in spinal fluid may result from the presence of large numbers of leucocytes, or from bacteria, increased protein, or lipid. If radiographic contrast media have been injected, the CSF will appear oily, and when mixed, turbid. This artifactual turbidity is not reported.

Clots

In addition to the gross observation of turbidity and color, the spinal fluid should be examined for clotting. Clotting may occur from increased fibrinogen resulting from a traumatic tap. Rarely, clotting may be associated with subarachnoid block, or meningitis.

Color (traumatic tap versus hemorrhage)

Bloody fluid can result from a traumatic tap or from subarachnoid hemorrhage. If blood in a specimen results from a traumatic tap (inclusion of blood in the specimen from the puncture itself), the successive collection tubes will show less bloody fluid, eventually becoming clear. If blood in a specimen is caused by a subarachnoid hemorrhage, the color of the fluid will look the same in all the collection tubes. In addition, subarachnoid bleeding is indicated by the presence of xanthochromia. This is the presence of a pale pink to orange or yellow color in the supernatant CSF. It is the result of the release of hemoglobin from hemolyzed red blood cells, which begins 1 to 4 hours after hemorrhage.

Red and white blood cell counts

Unlike cell counts on blood, cell counts on CSF (as is the case with all body fluids) are usually performed by manual methods. If the spinal fluid appears clear, cell

counts may be performed in a hemocytometer counting chamber without using diluting fluid. Cell counts should be performed promptly since cells begin to disintegrate within about 1 hour. If delay in testing is unavoidable, the specimen should be placed in a refrigerator at 2-10°C and dealt with at the earliest opportunity. Normally there are no red cells in CSF. The normal white cell count in CSF is 0 to 8 per μl . More than 10 per μl is considered abnormal. A predominance of polynuclear cells usually indicates a bacterial infection, while the presence of many mononuclear cells indicates a viral infection.

Morphologic examination

When the cell count is over 30 white cells per microliter, a differential cell count is done. This may be done on a smear made from the centrifuged spinal fluid sediment, by recovery with a filtration or sedimentation method, or preferably on a cytocentrifuged preparation (This technique requires the use of a special cytocentrifuge, such as the Cytospin). The spinal fluid is centrifuged for 5 minutes at 3000rpm. The supernatant is removed, and the sediment is used to prepare smears on glass slides. The smears are dried rapidly and stained with Wright stain. Any of the cells found in blood may be seen in CSF, including neutrophils, lymphocytes,

monocytes, eosinophils, and basophils. In addition, cells that originate in the CNS may be seen. These include ependymal, choroidal, and pia-arachnoid mesothelial (PAM) cells. If any tumor cells or unusual cells are encountered, the specimen should be referred for cytologic examination.

CSF red cell count

1. Insert a disposable Pasteur pipette directly into the well-mixed specimen. Carefully mount both sides of a clean counting chamber.
2. With the low power objective, quickly scan both ruled areas of the hemocytometer to determine whether red cells are present and to get a rough idea of their concentration.
3. With the high-power objective, count the red cells in 10mm^2 . Count five squares on each side, using the four corner squares and the center square.
4. Red cells will appear small, round, and yellowish. Their outline is usually smooth, although they may occasionally appear crenated.
5. If the number of red cells is fairly high (more than 200 cells per ten squares) count fewer squares and adjust the calculations accordingly.

Hematology

6. If the fluid is extremely blood, it may be necessary to dilute it volumetrically with saline or some other isotonic diluent. It is preferable to count the undiluted fluid in fewer than 10 squares, if possible. Adjust the calculations if dilution is necessary.
7. Calculate the number of cells per liter as follows:
Total cells counted X dilution factor X volume factor
= cells/ μ l

Example: If 10 squares are counted, the volume counted is $1\mu\text{l}$ ($10\text{mm}^2 \times 0.1\text{mm}$) and if the fluid was not diluted, there is no dilution factor. Therefore the number of cells counted in 10 squares is equal to the number of cells per microliter

CSF White cell count

1. Rinse a disposable Pasteur pipette with glacial acetic acid, drain it carefully, wipe the outside completely dry with gauze, and touch the tip of the pipette to the gauze to remove any excess acid.
2. Place the pipette in the well-mixed CSF sample and allow the pipette to fill to about 1 inch of its length.
3. Mix the spinal fluid with the acid coating the pipette by placing the pipette in a horizontal position and removing your finger from the end of the pipette. Rotate or twist the pipette to mix the CSF and acid

together.

4. Mount the acidified CSF on both sides of a clean hemocytometer. Wait for 3 to 5 minutes to allow time for red cell hemolysis.
5. With the low-power objective, quickly scan both ruled areas of the hemocytometer to determine whether white cells are present, and to get a rough idea of their concentration. The white cell nuclei will appear as dark, retractile structures surrounded by a halo of cytoplasm.
6. Using the low-power objective, count the white cells in 10mm^2 , 5mm^2 on each side of the hemocytometer using the four corner squares and the center square.
7. Do a chamber differential as the white cells are counted by classifying each white cell seen as polynuclear or mononuclear. This chamber differential is inaccurate, and a differential cell counts on a stained cytocentrifuged preparation is preferred.
8. If it appears that the number of white cells is more than 200 cells per ten squares, count fewer squares and adjust your calculations accordingly.
9. Calculate the white cell count in cells per microliter as describe in CSF red cell count

21.2 SEROUS FLUIDS ANALYSIS (PLEURAL, PERICARDIAL, AND PERITONEAL [ASCITIC] FLUIDS)

Serous fluids are the fluids contained within the closed cavities of the body. These cavities are lined by a contiguous membrane that forms a double layer of mesothelial cells, called the serous membrane. The cavities are the pleural (around the lungs), pericardial (around the heart), and peritoneal (around the abdominal and pelvic organs) cavities. A small amount of serous fluid fills the space between the two layers and serves to lubricate the surfaces of these membranes as they move against each other. The fluids are ultrafiltrates of plasma, which are continuously formed and reabsorbed, leaving only a very small volume within the cavities. An increased volume of any of these fluids is referred to as an effusion.

Since normal serous fluids are formed as an ultrafiltrate of plasma as it filters through the capillary endothelium, they are transudates. An increase in serous fluid volume (effusion) will occur in many conditions. In determining the cause of an effusion, it is helpful to

determine whether the effusion is a transudate or an exudate. In general, the effusion is a transudate (which is an ultrafiltrate of plasma) as the result of a systemic disease. An example of a transudate includes ascites, an effusion into the peritoneal cavity, which might be caused by liver cirrhosis or congestive heart failure. Transudates may be thought of as the result of a mechanical disorder affecting movement of fluid across a membrane. Exudates are usually effusions that result from an inflammatory response to conditions that directly affect the serous cavity. These inflammatory conditions include infections and malignancies.

Table 21.1 Differentiation of serous effusions:
Transudate from Exudate

Observation or Test	Transudate	Exudates
Appearance	Watery, clear, pale yellow, Does not clot	Cloudy, turbid, purulent, or bloody, May clot (fibrinogen)
White cell count	Low, <1000/ μ l, with more than 50% mononuclear cells	500-1000/ μ l or more, with increased PMNs, increased lymphocytes with tuberculosis or rheumatoid arthritis
Red cell count	Low, unless from a traumatic tap	>100000/ μ l, especially with a malignancy
Total protein	Low	>3g/dl (or grater than half the serum level)

Hematology

Lactate dehydrogenase	Varies with serum level	Increased (>60% of the serum level because of cellular debris)
Glucose		Lower than serum level with some infections and high cell counts

Serous fluids are collected under strictly antiseptic conditions. At least three anticoagulated tubes of fluids are generally collected and used as follows:

1. An EDTA tube for gross appearance, cell counts, morphology, and differential
2. A suitable anticoagulated tube for chemical analysis
3. A sterile heparinized tube for Gram stain and culture

Gross appearance

Normal serous fluid is pale and straw colored. This is the color seen in a transudate. Turbidity increases as the number of cells and the amount of debris increase. An abnormally colored fluid may appear milky (chylous or pseudochylous), cloudy, or bloody on gross

observation. A cloudy serous fluid is often associated with an inflammatory reaction, either bacterial or viral. Blood-tinged fluid can be seen as a result of a traumatic tap, and grossly bloody fluid can be seen when an organ such as the spleen or liver or a blood vessel has ruptured. Bloody fluids are also seen in malignant disease states, after myocardial infarction, in tuberculosis, in rheumatoid arthritis, and in systemic lupus erythematosus.

Clotting

To observe the ability of the serous fluid to clot, the specimen must be collected in a plain tube with no anticoagulant. Ability of the fluid to clot indicates a substantial inflammatory reaction.

Red and white Blood cell count

Cell counts are done on well-mixed anticoagulated serous fluid in a hemocytometer. The fluid may be undiluted or diluted, as indicated by the cell count. The procedure is essentially the same as that described for CSF red and white cell counts. If significant protein is present, acetic acid cannot be used as a diluent for white cell counts, owing to the precipitation of protein. In this case, saline may be used as a diluent and the red and white cell counts are done simultaneously. The use

Hematology

of phase microscopy is helpful in performing these counts. As with CSF cell counts, 10 square millimeters are generally counted using the undiluted fluid. Results are reported as the number of cells per microliter (or liter).

Leucocyte counts over $500/\mu\text{l}$ are usually clinically significant. If there is a predominance of neutrophils, bacterial inflammation is suspected. A predominance of lymphocytes suggests viral infection, tuberculosis, lymphoma, or malignancy. Leukocytes counts over $1000/\mu\text{l}$ are associated with exudates. Red cell counts of more than $10000/\mu\text{l}$ may be seen as effusion with malignancies, infarcts, and trauma.

Morphologic examination and white cell differential

Morphologic examination and white cell differential are essentially the same as described for CSF. Slides are generally stained with Wright stain, and a differential cell count is done. The white cells generally resemble those seen in peripheral blood, with the addition of mesothelial lining cells. Generally 300 cells are counted and differentiated as to percentage of each cell type seen. If any malignant tumor cells are seen or appear to be present, the slide must be referred to a pathologist or

qualified cytotechnologist.

21.3 SYNOVIAL FLUID

Synovial fluid is the fluid contained in joints. Normal synovial fluid is an ultrafiltrate of plasma with the addition of a high molecular-weight mucopolysaccharide called hyaluronate or hyaluronic acid. The presence of hyaluronate differentiates synovial fluid from other serous fluids and spinal fluid. It is responsible for the normal viscosity of synovial fluid, which serves to lubricate the joints so that they move freely. This normal viscosity is responsible for some difficulties in the examination of synovial fluid, especially in performing cell counts.

Normal synovial fluid

Normal synovial fluid is straw colored and viscous, resembling uncooked egg white. The word synovial comes from syn, with, and ovi, egg. About 1ml of synovial fluid is present in each large joint, such as the knee, ankle, hip, elbow, wrist, and shoulder. In normal synovial fluid the white cell count is low, less than 200/ μ l,

and the majority of the white cells are mononuclear, with less than 25% neutrophils. Red cell and crystals are normally absent, and the fluid is sterile. Since the fluid is an ultrafiltrate of plasma, normal synovial fluid has essentially the same chemical composition as plasma without the larger protein molecules.

Aspiration and analysis

The aspiration and analysis of synovial fluid may be done to determine the cause of joint disease, especially when accompanied by an abnormal accumulation of fluid in the joint (effusion). The joint disease (arthritis) might be crystal induced, degenerative, inflammatory, or infectious. Morphologic analysis of cells and crystals, together with Gram stain and culture, will help in the differentiation. Effusion of synovial fluid is usually present clinically before aspiration, and therefore it is often possible to aspirate 10 to 20ml of the fluid for laboratory examination, although the volume (which is normally about 1ml) may be extremely small, so that the laboratory receives only a drop of fluid contained in the aspiration syringe.

Collection of synovial fluid

Synovial fluid is collected by needle aspiration, which is called arthrocentesis. It is done by experienced persons under strictly sterile conditions. The fluid is collected with a disposable needle and plastic syringe, to avoid contamination with confusing birefringent material. The fluid should be collected both anticoagulated and unanticoagulated. Ideally the fluid should be divided into three parts.

1. A sterile tube for microbiological examination
2. A tube with liquid EDTA or sodium heparin for microscopic examination
3. A plain tube (without anticoagulant) for clot formation, gross appearance, and chemical and immunologic procedures.

Oxalate, powdered EDTA, and lithium heparin anticoagulants should not be used, as they may appear as confusing crystals in the crystal analysis. This is especially true when only a small volume of fluid is aspirated, giving an excess of anticoagulant, which may crystallize.

Normal synovial fluid does not clot, and therefore an

anticoagulant is unnecessary. However, infectious and crystal-induced fluids tend to form fibrin clots, making an anticoagulant necessary for adequate cell counts and an even distribution of cells and crystals for morphologic analysis. Although an anticoagulant will prevent the formation of fibrin clots, it will not affect viscosity. Therefore, if the fluid is highly viscous, it can be incubated for several hours with a 0.5% solution of hyaluronidase in phosphate buffer to break down the hyaluronate. This reduces the viscosity, making the fluid easier to pipette and count.

Routine examination of synovial fluid

The routine examination of synovial fluid should include the following

1. Gross appearance (color, clarity, and viscosity)
2. Microbiological studies
3. WBC and differential cell counts
4. polarizing microscopy for crystals
5. Other tests, as necessary

Gross appearance

The first step in the analysis of synovial fluids is to

Hematology

observe the specimen for color and clarity. The noninflammatory fluid is usually clear. To test for clarity, read newspaper print through a test tube containing the specimen. As the cell and protein content increases, or crystals precipitate, the turbidity increases, and the print becomes more difficult to read. In a traumatic tap of the joint, blood will be seen in the collection tubes in an uneven distribution with streaks of blood in the aspiration syringe. A truly bloody fluid is uniform in color, and does not clot. Xanthochromia in the supernatant fluid indicates bleeding in the joint, but is difficult to evaluate because the fluid is normally yellow. A dark-red or dark-brown supernatant is evidence of joint bleeding rather than a traumatic tap.

Viscosity

Viscosity is most easily evaluated at the time of arthrocentesis by allowing the synovial fluid to drop from the end of the needle. Normally, synovial fluid will form a string 4 to 6cm in length. If it breaks before it reaches 3cm in length, the viscosity is lower than normal. Inflammatory fluids contain enzymes that break down hyaluronic acid. Anything that decreases the hyaluronic acid content of synovial fluid lowers its viscosity.

Viscosity has been evaluated in the laboratory by means of the mucin clot test. However, this test is of questionable value, as results rarely change the diagnosis and are essentially the same as with the string test for viscosity. Therefore, it is no longer recommended as part of the routine synovial fluid analysis.

Red cell and White Blood cell count

The appearance of a drop of synovial fluid under an ordinary light microscope can be helpful in estimating the cell counts initially and in demonstrating the presence of crystals. The presence of only a few white cells per high power field suggests a noninflammatory disorder. A large number of white cells would indicate inflammatory or infected synovial fluid. The total WBC count and differential count are very important in diagnosis. When cells are counted in other fluid, such as blood, the usually diluting fluid is dilute acetic acid. This cannot be used with synovial fluid because it may cause mucin clotting. Instead, a solution of saline containing methylene blue is used. If it is necessary to lyse red blood cells, either hypotonic saline or saponinized saline can be used as a diluent. The undiluted synovial fluid, or, if necessary, suitably diluted

fluid, is mounted in a hemocytometer and counted as described for CSF counts. Since acetic acid cannot be used as a diluent, both red and white cells are enumerated at the same time. This is most easily accomplished by using a phase-contrast rather than a brightfield microscope.

Cell counts below 200/ μl with less than 25% polymorphonuclear cells and no red cells are normally observed in synovial fluid. Monocytes, lymphocytes, and macrophages are seen. A low white cell count (200 to 2000/ μl) with predominantly mononuclear cells suggests a noninflammatory joint fluid, while a high white cell count suggests inflammation and a very high white cell count with a high proportion of polymorphonuclear cells strongly suggests infection.

Morphologic examination

As with CSF, cytocentrifuged preparations of the synovial fluid are preferred for the morphologic examination and white cell differential. If a cytocentrifuge is not available, smears are made, as for CSF, from normally centrifuged sediment. The smears

Hematology

are air dried and stained with Wright stain. These preparations may also be used for crystal identification. The procedure is generally the same as that described for CSF.

Lupus erythematosus (LE) cells may be found in stained slides from patients with systemic lupus erythematosus and occasionally in fluid from patients with rheumatoid arthritis. The in vivo formation of LE cells in synovial fluid probably results from trauma to the white cells. Eosinophilia may be seen in metastatic carcinoma to the synovium, acute rheumatic fever, and rheumatoid arthritis. It is also associated with parasitic infections and Lyme disease and has occurred after arthrography and radiation therapy.

21.4 SEMEN ANALYSIS

Seminal fluid (semen) consists of a combination of products of various male reproductive organs: testes and epididymis, seminal vesicles, prostate and bulbourethral and urethral glands. Each product or fraction varies in its individual composition, each contributing to the whole specimen. During ejaculation,

the products are mixed in order to produce the normal viscous semen specimen or ejaculate.

Semen analysis is done for several reasons. These include assessment of fertility or infertility, forensic purposes, determination of the effectiveness of vasectomy, and determination of the suitability of semen for artificial insemination procedures.

Collection of semen specimen

Give the person a clean, dry, leak-proof container, and request him to collect a specimen of semen at home following 3-7 days of sexual abstinence. When a condom is used to collect the fluid, this must be well-washed to remove the powder which coats the rubber. It must be dried completely before being used. Coitus interruptus method of collection should not be used because the first portion of the ejaculate (often containing the highest concentration of spermatozoa) may be lost. Also the acid pH of vaginal fluid can affect sperm motility and the semen may become contaminated with cells and bacteria. During transit to the laboratory, the fluid should be kept as near as possible to body temperature. This is best achieved by placing the container inside a plastic bag and

transporting it in a pocket in the person's clothing.

Laboratory assays

The sample should be handled with care because it may contain infectious pathogens, e.g. HIV, hepatitis, viruses, herpes viruses. When investigating infertility, the basic analysis of semen (seminal fluid) usually includes:

- Measurement of volume
- Measurement of pH
- Examination of a wet preparation to estimate the percentage of motile spermatozoa and viable forms and to look for cells and bacteria
- Sperm count
- Examination of a stained preparation to estimate the percentage of spermatozoa with normal morphology

Measurement of volume

Normal semen is thick and viscous when ejaculated. It becomes liquefied usually within 60 minutes due to a fibrinolysin in the fluid. When liquefied, measure the volume of fluid in milliliters using a small graduated cylinder. A normal specimen is usually 2ml or more.

Measurement of pH

Hematology

Using a narrow range pH paper, e.g. pH 6.4-8.0, spread a drop of liquefied semen on the paper. After 30 second, record the pH.

pH of normal semen: Should be pH 7.2 or more within 1 hour of ejaculation. When the pH is over 7.8 this may be due to infection. When the pH is below 7.0 and the semen is found to contain no sperm, this may indicate dysgenesis (failure to develop) of the vas deferens, seminal vesicles or epididymis.

Estimate the percentage of motile and viable spermatozoa

Motility: Place 1 drop (one drop falling from a 21g needle is equivalent to a volume of 10-15 μ l) of well-mixed liquefied semen on a slide and cover with a 20x20mm or 22x22mm cover glass. Focus the specimen using the low power objective. Close the condenser iris sufficiently to give good contrast. Ensure the spermatozoa are evenly distributed (if not, re-mix the semen and examine a new preparation). Using the high power objective, examine several fields to assess motility, i.e. whether excellent (rapid and progressive) or weak (slow and non-progressive). Count a total of 100 spermatozoa, and note out of the hundred how many

Hematology

are motile. Record the percentages that are motile and non-motile.

Normal motility: Over 50% of spermatozoa are motile within 60 minutes of ejaculation. The spermatozoa remain motile for several hours. When more than 60% of spermatozoa are non-motile, examine an eosin preparation to assess whether the spermatozoa are viable or non-viable. Report when more than a few leucocytes (pus cells) or red cells are present. When pus cells are seen, examine a Gram stained smear for bacteria.

Viability: Mix one drop (10-15 μ l) of semen with 1 drop of 0.5% eosin solution on a slide. After 2 minutes examine the preparation microscopically. Use the low power objective to focus the specimen and the high power objective to count the percentage of viable and non-viable spermatozoa. Viable spermatozoa remain unstained, non-viable spermatozoa stain red.

Normal viability: 75% or more of spermatozoa should be viable (unstained). A large proportion of non-motile but viable spermatozoa may indicate a structural defect in the flagellum.

Perform a sperm count

Using a graduated tube or small cylinder, dilute the semen 1 in 20 with a staining solution (sodium bicarbonate, formalin, and a stain of trypan blue or saturated aqueous gentian violet is one diluent that can be used). Using a Pasteur pipette, fill an Improved Neubauer ruled chamber with well-mixed diluted semen. Wait 3-5 minutes for the spermatozoa to settle. Using the low power objective with the condenser iris closed sufficiently to give good contrast, count the number of spermatozoa in an area of 2 sq mm, i.e. 2 large squares. Calculate the number of spermatozoa in 1ml of fluid by multiplying the number counted by 100000.

Normal count: 20×10^6 spermatozoa/ml or more. Counts less than 20×10^6 /ml are associated with male sterility.

Estimate the percentage of spermatozoa with normal morphology in a stained preparation

Make a thin smear of the liquefied well-mixed semen on a slide. While still wet, fix the smear with 95% v/v ethanol for 5-10 minutes, and allow to air-dry. Wash the smear with sodium bicarbonate-formalin solution to remove any mucus which may be present. Rinse the smear with several changes of water. Cover the smear with dilute (1 in 20) carbon fuchsin and allow to stain for

Hematology

3 minutes. Wash off the stain with water. Counterstain, by covering the smear with dilute (1 in 20) Loeffler's methylene blue for 2 minutes. Wash off the stain with water. Drain, and allow the smear to air-dry. Other staining techniques used to stain spermatozoa include Giemsa and Papanicolaou.

Examine the preparation for normal and abnormal spermatozoa using the high power objective. Use the 100x objective to confirm abnormalities. Count 100 spermatozoa and estimate the percentage showing normal morphology and the percentage that appear abnormal. Abnormal semen findings should be checked by examining a further specimen, particularly when the sperm count is low and the spermatozoa appear non-viable and abnormal. When the abnormalities are present in the second semen, further tests are indicated in a specialist center.

Normal spermatozoa: measure 50-70 μ m in length. Each consists of an oval-shaped head (with acrosomal cap) which measures 3-5 x 2-3 μ m, a short middle piece, and a long thin tail (at least 45 μ m in length). In normal semen, at least 50% of spermatozoa should show

normal morphology. Most specimens contain no more than 20% abnormal forms. Staining feature: Nucleus of head-dark blue; cytoplasm of head-pale blue; Middle piece and tail-pink-red.

Abnormal spermatozoa: the following abnormalities may be seen:

- **Head:** greatly increased or decreased in size; abnormal shape and tapering head (pyriform); acrosomal cap absent or abnormally large; Nucleus contains vacuoles or chromatin in unevenly distributed; two heads; additional residual body, i.e. cytoplasmic droplet.
- **Middle piece:** absent or markedly increase in size; appears divided (bifurcated); angled where it meets tail.
- **Tail:** absent or markedly reduced in length; double tail; bent or coiled tail.

Reference ranges for semen analysis

Test parameter	Reference range
Volume	2.0ml or more
pH	7.2-8.0
Sperm concentration	>20 x 10 ⁶ spermatozoa/ml

Hematology

Total sperm count	>40 x 10 ⁶ spermatozoa per ejaculate
Morphology	>30% with normal forms
Vitality/viability	>75% live forms
White blood cells	<1 x 10 ⁶ /ml
Red blood cells	None

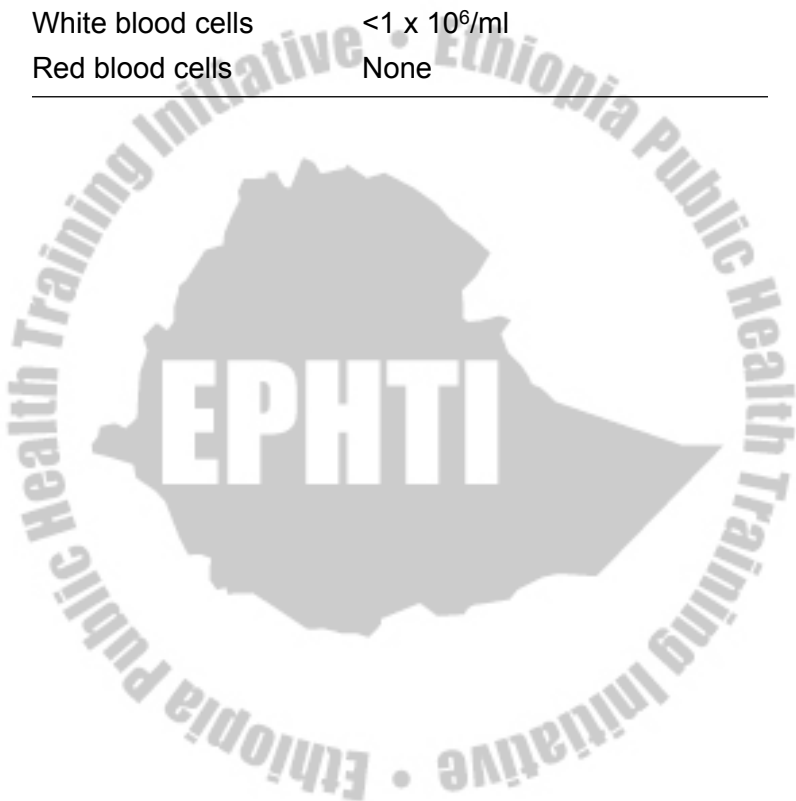

Review Questions

1. What are the different types of body fluids
2. Explain the analysis of cerebrospinal fluid
3. Describe the analysis of serous fluid, synovial fluid and semen

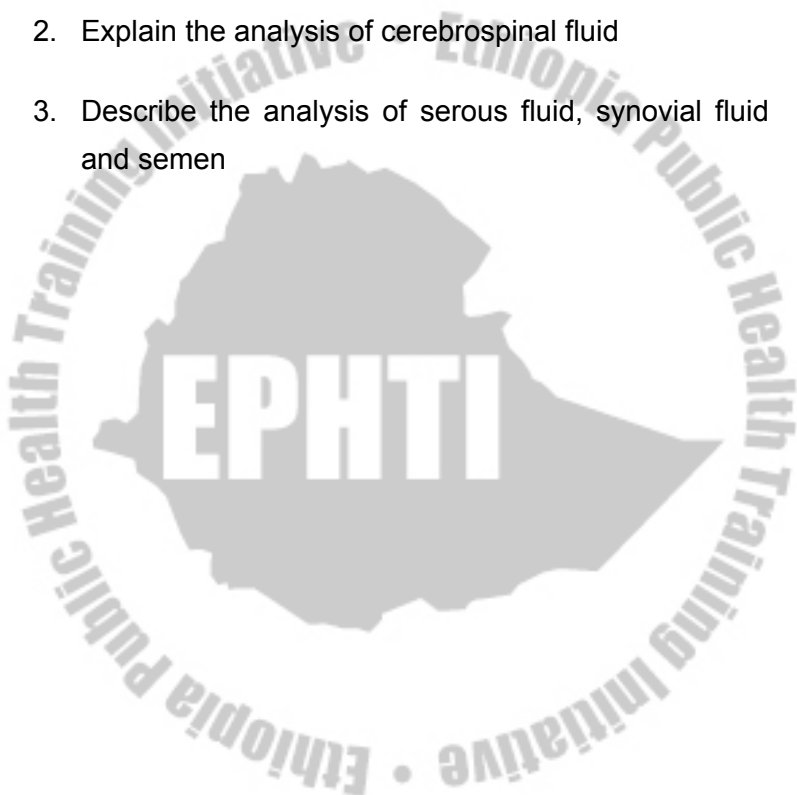

CHAPTER TWENTY TWO

AUTOMATION IN HEMATOLOGY

Learning objectives

At the end of this chapter, the student shall be able to:

- Describe the importance of automation in hematology
- Mention the shortcoming of automated methods in the laboratory
- Explain the principle for automated cell counting

Introduction

More and more laboratory tests per patient are ordered every year; the variety of tests available has also increased, and tests results are generated more quickly, providing the physician with medically useful information. The fast turnaround time required in today's medical practices has affected the instrumentation required, including the devices used for point-of-care testing (POCT). One of the major technologic changes in the clinical laboratory has been the introduction of automated analysis. An automated analytic instrument

Hematology

provides a means for transfer of a specimen within its complex assembly to a series of self-acting components, each of which carries out a specific process or stage of the process, ending in the analytic result being produced. Automation provides a means by which an increased workload can be processed rapidly and reproducibly. It does not necessarily improve the accuracy of the results.

Automation can be applied to any or all of the steps used to perform any manual assay. Automation systems include some kind of device for sampling the patient's specimen or other samples to be tested (such as blanks, controls, and standard solutions), a mechanism to add the necessary amounts of reagents in the proper sequence, incubation modules when needed for the specific reaction, monitoring or measuring devices such as photometric technology to quantitate the extent of the reaction, and a recording mechanism to provide the final reading or permanent record of the analytic result.

Use of automation

In hematology, automation has made a great change in the way work is done. Electronic cell counters have

replaced manual counting of blood cells even in clinics and physicians' office laboratories. There is an automated system for Wright's staining of blood smears. For coagulation studies several automated and semiautomated systems are available. Prothrombin time and activated partial thromboplastin time determinations can be done automatically on various instruments. Semiautomatic instruments are also used, especially for dilution steps. Several instruments are available for precise and convenient diluting, which both aspirate the sample and wash it out with the diluent. Some automatic diluters dispense and dilute in separate processes.

Disadvantages of automation

Some problems that may arise with may automated units are as follows:

- There may be limitations in the methodology than can be used
- With automation, laboratorians are often discouraged from making observations and using their own judgment about potential problems
- Many systems are impractical for small numbers of samples, and therefore manual methods are still

Hematology

necessary as back-up procedures for emergency individual analyses

- Back-up procedures must be available in case of instrument failures
- Automated systems are expensive to purchase and maintain-regular maintenance requires personnel time as well as the time of trained service personnel
- There is often an accumulation of irrelevant data because it is so easy to produce the results-tests are run that are not always necessary.

Automation in Hematology

Automation provides both greater accuracy and greater precision than manual method. Over the last 20 years, instrumentation has virtually replaced manual cell counting, with the possible exception of phase platelet counting as confirmatory procedure. Hematology analyzers have been developed and are marketed by multiple instrument manufacturers. These analyzers typically provide the eight standard hematology parameters (complete blood count [CBC] plus a three-part or five part differential leucocyte counts in less than one minute on 100 μ l of whole blood. Automation thus allows for more efficient workload management and more timely diagnosis and treatment of disease. The

best source of information about the various instruments available is the manufacturers' product information literature. The continual advances in commercial instruments for hematologic use and their variety preclude an adequate description of them in this chapter. Some basic, general information follows, however.

General principles of hematology instrumentation

Despite the number of hematology analyzers available from different manufacturers and with varying levels of sophistication and complexity, two basic principles of operation are primarily used: **electronic impedance** (resistance) and **optical scatter**. Electronic impedance, or low-voltage direct current (DC) resistance, was developed by Wallace Coulter in the 1950s and is the most common methodology used. Radio frequency (RF), or high-voltage electromagnetic current resistance, is sometimes used in conjunction with DC electronic impedance. Technicon Instruments introduced dark field optical scanning in the 1960s, and Ortho Diagnostics systems followed with a laser-based optical instrument in the 1970s. Optical scatter, utilizing both laser and nonlaser light, is frequently used on today's hematology instrumentation.

Electrical impedance

The impedance principle of cell counting is based on the detection and measurement of changes in electrical resistance produced by cells as they traverse a small aperture. Cells suspended in an electrolytically conductive diluent such as saline are pulled through an aperture (orifice) in a glass tube. In the counting chamber, or transducer assembly, low-frequency electrical current is applied between an external electrode (suspended in the cell dilution) and an internal electrode (housed inside the aperture tube). Electrical resistance between the two electrodes, or impedance in the current, occurs as the cells pass through the sensing aperture, causing voltage pulses that are measurable. Oscilloscope screens on some instruments display the pulses that are generated by the cells as they interrupt the current. The number of pulses is proportion to the number of cells counted.

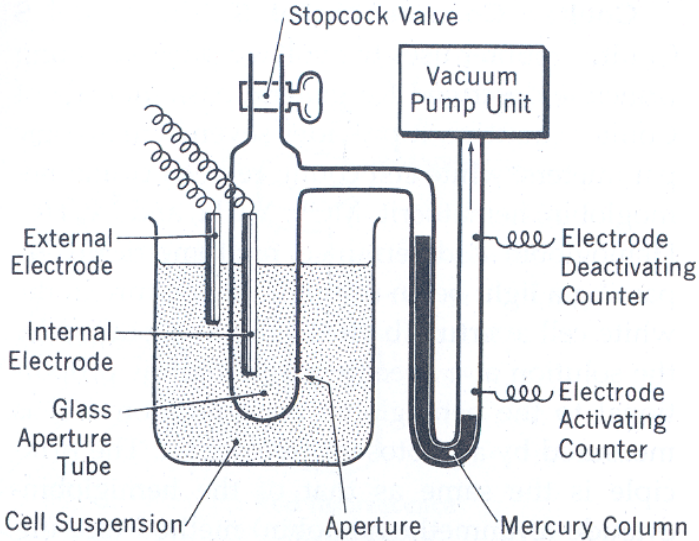

Fig. 22.1 Coulter principle of cell counting based on Electronic impedance.

The size of the voltage pulse is directly proportional to the size (volume) of the cell, thus allowing discrimination and counting of specific-sized cells through the use of threshold circuits. Pulses are collected and sorted (channelized) according to their amplitude by pulse height analyzers. The data are plotted on a frequency distribution graph, or size distribution histogram, with relative number on the y-axis and size (channel number

equivalent to specific size) on the x-axis. The histogram produced depicts the volume distribution of the cells counted. Size thresholds separate the cell populations on the histogram, with the count being the cells enumerated between the lower and upper set thresholds for each population. Size distribution histograms may be used for the evaluation of one cell population or subgroups within a population. The use of proprietary lytic reagents, as used on the older Coulter S-plus IV, STKR, and sysmex E-5000 to control shrinkage and lysis of specific cell types, allows for separation and quantitation of white blood cells into three populations (lymphocytes, mononuclear cells, and granulocytes) for the “three-part differential” on one size distribution histogram.

Optical scatter

Optical scatter may be used as the primary methodology or in combination with other methods. In optical scatter systems (flow cytometers), a hydro-dynamically focused sample stream is directed through a quartz flow cell past a focused light source. The light source is generally a tungsten-halogen lamp or a helium-neon laser (Light Amplification by Stimulated Emission of Radiation). Laser light, termed monochromatic light since it is

Hematology

emitted as a single wavelength, differs from bright field light in its intensity, its coherence (i.e. it travels in phase), and its low divergence or spread. These characteristics allow for the detection interference in the laser beam and enable enumeration and differentiation of cell types. Optical scatter may be used to study RBCs, WBCs, and platelets.

As the cells pass through the sensing zone and interrupt the beam, light is scattered in all directions. Light scatter results from the interaction between the processes of absorption, (diffraction bending around corners or surface of cell), refraction (bending because of a change in speed), and reflection (backward rays caused by obstruction). The detection and conversion of scattered rays into electrical signals is accomplished by photo detectors (photodiodes and photo multiplier tubes [PMTs]) at specific angles. Lenses fitted with blocker bars to prevent nonscattered light from entering the detector are used to collect the scattered light. A series of filters and mirrors separate the varying wavelengths and present them to the photo detectors. Photodiodes convert light photons to electronic signals proportional in magnitude to the amount of light collected. PMTs are used to collect the weaker signals

Hematology

produced at a 90 degree angle and multiply the photoelectrons into stronger, useful signals. Analog-to-digital converters change the electronic pulses to digital signals for computer analysis.

Forward-angle light scatter (0 degrees) correlates with cell volume or size, primarily because of diffraction of light. Orthogonal light scatter (90 degrees), or side scatter, results from refraction and reflection of light from larger structures inside the cell and correlates with degree of internal complexity. Forward low-angle scatter (2-3 degrees) and forward high-angle scatter (5-15 degrees) also correlate with cell volume and refractive index or with internal complexity, respectively. Differential scatter is the combination of this low- and high-angle forward light scatter, primarily utilized on Bayer systems for cellular analysis. The angles of light scatter measure by the different flow cytometers are manufacturer and method specific.

Review Questions

1. State the importance of automation in hematology
2. Briefly describe the limitation of automated methods in the laboratory
3. Explain the principle for automated cell counting

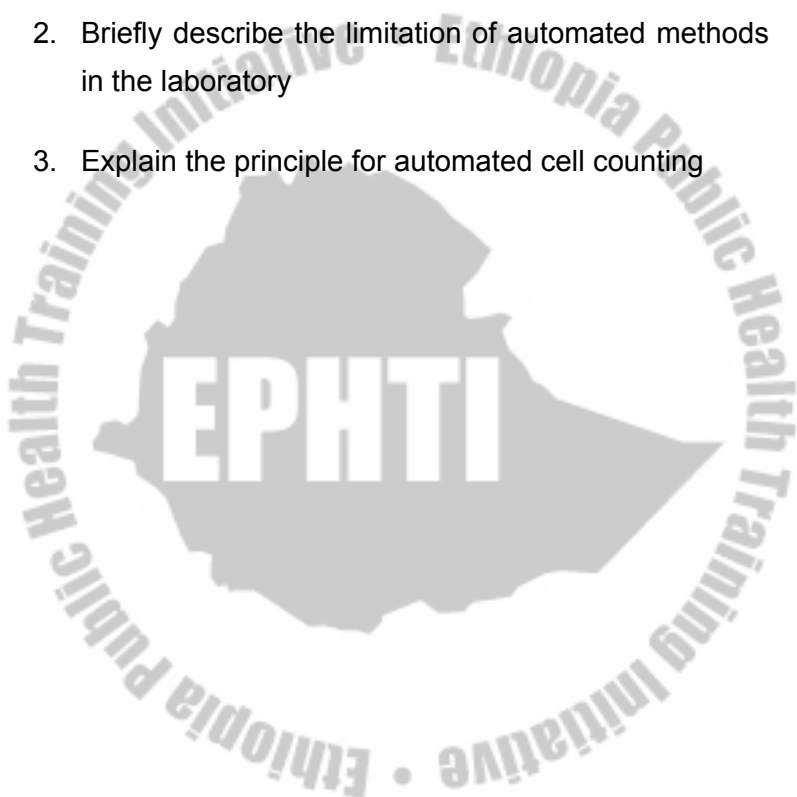

GLOSSARY

Acanthocyte	An abnormally shaped erythrocyte with spicules of varying length irregularly distributed over the cell membrane's outer surface; also known as a spur cell. There is no central area of pallor.
Activated lymphocyte	See reactive lymphocyte.
Activated protein C resistance (APCR)	A condition in which activated protein C is not able to inactivate factor V, which may cause or contribute to thrombosis. In most cases it is due to a mutation in factor V in which Arg 506 is replaced with Gln (factor V Leiden).
Acute leukemia	A malignant hematopoietic stem cell disorder characterized by proliferation and accumulation of immature and nonfunctional hematopoietic cells in the bone marrow and other organs.
Acute lymphocytic leukemia (ALL)	A malignant lymphoproliferative disorder characterized by proliferation and accumulation of lymphoid cells in the bone marrow. Peripheral blood smear reveals the presence of many undifferentiated or minimally differentiated cells.
Acute myelocytic leukemia (AML)	A malignant myeloproliferative disorder characterized by proliferation and accumulation of primarily undifferentiated or minimally differentiated myeloid cells in the bone marrow.
Acute phase reactant	Plasma protein that rises rapidly in response to inflammation, infection, or tissue injury.
Acute undifferentiated leukemia (AUL)	A malignant proliferation and accumulation of immature cells in the bone marrow that do not have characteristics of either myeloid or lymphoid cells.

Hematology

Adsorbed plasma	Platelet-poor plasma that is adsorbed with either barium sulfate or aluminum hydroxide to remove the coagulation factors II, VII, IX, X (the prothrombin group). Factors V, VIII, XI, XII, and fibrinogen (I) are present in adsorbed plasma. This plasma is one of the reagents used in the substitution studies to determine a specific factor deficiency.
Afibrinogenemia	A condition in which there is absence of fibrinogen in the peripheral blood. It may be caused by a mutation in the gene controlling the production of fibrinogen or by an acquired condition in which fibrinogen is pathologically converted to fibrin.
Aged serum	Serum that lacks coagulation factors fibrinogen (I), prothrombin (II), V, VIII. Aged serum is prepared by incubating normal serum for 24 hours at 37°C. Factors VII, IX, X, XI, and XII are present in aged serum. This serum is one of the reagents used in the substitution studies to determine a specific factor deficiency.
Agglutinate	Clumping together of erythrocytes as a result of interactions between membrane antigens and specific antibodies.
Aggregating reagent	Chemical substance (agonist) that promotes platelet activation and aggregation by attaching to a receptor on the platelet's surface.
Agranulocytosis	Absence of granulocytes in the peripheral blood.

Hematology

Alder-Reilly anomaly	A benign condition characterized by the presence of leukocytes with large purplish granules in their cytoplasm when stained with a Romanowsky stain. These cells are functionally normal.
Aleukemic leukemia	Leukemia in which the abnormal malignant cells are found only in the bone marrow.
Alloimmune hemolytic anemia	A hemolytic anemia generated when blood cells from one person are infused into a genetically unrelated person. Antigens on the infused donor cells are recognized as foreign by the recipient's lymphocytes, stimulating the production of antibodies. The antibodies react with donor cells and cause hemolysis.
Alpha granules	Platelet storage granules containing a variety of proteins that are released into an area after an injury.
Anemia	A decrease in the normal concentration of hemoglobin or erythrocytes. This may be caused by increased erythrocyte loss or decreased erythrocyte production. Anemia may result in hypoxia.
Anisocytosis	A term used to describe a general variation in erythrocyte size.
Antibody	An immunoglobulin produced in response to an antigenic substance.

Hematology

Anticoagulant	Chemical substance added to whole blood to prevent blood from coagulating. Depending on the type of anticoagulant, in vitro coagulation is prevented by the removal of calcium (EDTA) or the inhibition of the serine proteases such as thrombin (heparin).
Antigen	Any foreign substance that evokes antibody production (an immune response) and reacts specifically with that antibody.
Antihuman globulin (AHG)	A globulin used in a laboratory procedure that is designed to detect the presence of antibodies directed against erythrocyte antigens on the erythrocyte membrane.
Apheresis	To separate or remove. Whole blood is withdrawn from the donor or patient and separated into its components. One of the components is retained, and the remaining constituents are recombined and returned to the individual.
Aplasia	The failure of hematopoietic cells to generate and develop in the bone marrow.
Aplastic anemia	An anemia characterized by peripheral blood pancytopenia and hypoplastic marrow. It is considered a pluripotential stem cell disorder.
Apo ferritin	Cellular protein that combines with iron to form ferritin. It is only found attached to iron, not in the free form.
Apoptosis	Programmed cell death resulting from activation of a predetermined sequence of intracellular events; "cell suicide."

Hematology

APSAC	Acylated plasminogen streptokinase activator complex; a modification of the enzyme, streptokinase, that is a chemically altered complex of streptokinase and plasminogen and is used as a thrombolytic agent in the treatment of thrombosis.
APTT	A laboratory test that measures fibrin forming ability of coagulation factors in the intrinsic coagulation cascade.
Arachidonic acid (AA)	An unsaturated essential fatty acid, usually attached to the second carbon of the glycerol backbone of phospholipids, released by phospholipase A ₂ and a precursor of prostaglandins and thromboxanes.
Ascites	Effusion and accumulation of fluid in the peritoneal cavity.
Ascitic fluid	Fluid that has abnormally collected in the peritoneal cavity of the abdomen.
Atypical lymphocyte	See reactive lymphocyte.
Auer rods	Reddish blue staining needle-like inclusions within the cytoplasm of leukemic myeloblasts that occur as a result of abnormal cytoplasmic granule formation. Their presence on a Romanowsky stained smear is helpful in differentiating acute myeloid leukemia from acute lymphoblastic leukemia.
Autoantibodies	Antibodies in the blood that are capable of reacting with the subject's own antigens.
Autohemolysis	Lysis of the subject's own erythrocytes by hemolytic agents in the subject's serum.

Hematology

Autoimmune hemolytic anemia (AIHA)	Anemia that results when individuals produce antibodies against their own erythrocytes. The antibodies are usually against high incidence antigens.
Autosome	Chromosomes that do not contain genes for sex differentiation; in humans, chromosome pairs 1—22.
Autosplenectomy	Extensive splenic damage secondary to infarction. This is often seen in older children and adults with sickle cell anemia.
Azurophilic granules	The predilection of some granules (primary granules) within myelocytic leukocytes for the aniline component of a Romanowsky type stain. These granules appear bluish purple or bluish black when observed microscopically on a stained blood smear. They first appear in the promyelocyte.
Band neutrophil	The immediate precursor of the mature granulocyte. These cells can be found in either the bone marrow or peripheral blood. The nucleus is elongated and nuclear chromatin condensed. The cytoplasm stains pink, and there are many specific granules. The cell is 9—15 μm in diameter. Also called a stab or unsegmented neutrophil.

Hematology

Basophil

A mature granulocytic cell characterized by the presence of large basophilic granules. These granules are purple blue or purple black with romanowsky stain. The cell is 10—14 μm in diameter, and the nucleus is segmented.

Granules are cytochemically positive with periodic acid-schiff (PAS) and peroxidase. The granules contain histamine and heparin peroxidase. Basophils constitute $<0.2 \times 10^9/\text{L}$ or 0—1% of peripheral blood leukocytes. The basophil functions as a mediator of inflammatory responses. The cell has receptors for IgE. An increase in the concentration of circulating basophils.

Basophilia

Basophilic normoblast

A nucleated precursor of the erythrocyte that is derived from a pronormoblast. The cell is 10—16 μm in diameter. The nuclear chromatin is coarser than the pronormoblast, and nucleoli are usually absent. Cytoplasm is more abundant and it stains deeply basophilic. The cell matures to a polychromatophilic normoblast. Also called a prorubricyte.

Basophilic stippling

Erythrocyte inclusions composed of precipitated ribonucleoprotein and mitochondrial remnant. Observed on Romanowsky stained blood smears as diffuse or punctate bluish black granules in toxic states such as drug (lead) exposure. Diffuse, fine basophilic stippling may occur as an artifact.

B cell ALL

An immunologic type of ALL in which the neoplastic cell is a B lymphoid cell. There are subtypes.

Hematology

Bence-Jones protein	Excessive immunoglobulin light chains in the urine.
Benign	Nonmalignant. Formed from highly organized, differentiated cells that do not spread or invade surrounding tissue.
Bilineage leukemia	A leukemia that has two separate populations of leukemic cells, one of which phenotypes as lymphoid and the other as myeloid.
Biphenotypic leukemia	An acute leukemia that has myeloid and lymphoid markers on the same population of neoplastic cells.
Birefringent	Characteristic of a substance to change the direction of light rays that are directed at the substance; can be used to identify crystals.
Bleeding time and PFA 100	A screening test that measures platelet function.
Blood coagulation	Formation of a blood clot, usually considered a normal process.
Bohr effect	The effects of pH on hemoglobin-oxygen affinity. This is one of the most important buffer systems in the body. As the H ⁺ concentration in tissues increases, the affinity of hemoglobin for oxygen is decreased, permitting unloading of oxygen.
Bone marrow trephine biopsy	Removal of a small piece of the bone marrow core that contains marrow, fat, and trabecula. Examination of the trephine biopsy is useful in observing the bone marrow architecture and cellularity and allows interpretation of the spatial relationships of bone, fat, and marrow cellularity.

Hematology

Buffy coat	The layer of white blood cells and platelets that lies between the plasma and erythrocytes in centrifuged blood sample.
Burkitt's cell	Lymphoblast that is found in Burkitt's lymphoma.
Butt cell	Circulating neoplastic lymphocyte with a deep indentation (cleft) of the nuclear membrane. Butt cells may be seen when follicular lymphoma involves the peripheral blood.
Cabot ring	Reddish-violet erythrocyte inclusion resembling the figure 8 on Romanowsky stained blood smears that can be found in some cases of severe anemia.
Carboxyhemoglobin	Compound formed when hemoglobin is exposed to carbon monoxide; it is incapable of oxygen transport.
Cerebrospinal fluid (CSF)	Fluid that is normally produced to protect the brain and spinal cord. It is produced by the choroid plexus cells, absorbed by the arachnoid pia and circulates in the subarachnoid space.
Cheidak-Higashi anomaly	A multisystem disorder inherited in an autosomal recessive fashion and characterized by recurrent infections, hepatospleomegaly, partial albinism, CNS abnormalities; neutrophil chemotaxis and killing of organisms is impaired. There are giant cytoplasmic granular inclusions in leukocytes and platelets.
Chromosome	Nuclear structure seen during mitosis and meiosis consisting of supercoiled DNA with histone and nonhistone proteins. Consists of two identical (sister) chromatids attached at the centromere.

Hematology

Chronic idiopathic thrombocytopenic purpura (ITP) **Chronic lymphocytic leukemia (CLL)**

An immune form of thrombocytopenia that occurs most often in young adults and lasts longer than six months.

A lymphoproliferative disorder characterized by a neoplastic growth of lymphoid cells in the bone marrow and an extreme elevation of these cells in the peripheral blood. It is characterized by leukocytosis, <30% blasts, and a predominance of mature lymphoid cells.

Chronic myelocytic leukemia (CML)

A myeloproliferative disorder characterized by a neoplastic growth of primarily myeloid cells in the bone marrow and an extreme elevation of these cells in the peripheral blood. There are two phases to the disease: chronic and blast crisis. In the chronic phase, there are less than 30% blasts in the bone marrow or peripheral blood, whereas in the blast crisis phase there are more than 30% blasts. Individuals with this disease have the BCR/ABL translocation, which codes for a unique P210 protein. Also referred to as chronic granulocytic leukemia (CGL).

Chronic myelomonocytic leukemia (CMML)

A subgroup of the myelodysplastic syndromes. There is anemia and a variable total leukocyte count. An absolute monocytosis ($>1 \times 10^9/L$) is present and immature erythrocytes and granulocytes may also be present. There are less than 5% blasts in the peripheral blood. The bone marrow is hypercellular with proliferation of abnormal myelocytes, promonocytes, and monoblasts, and there are <20% blasts.

Hematology

Chronic nonspherocytic hemolytic anemia	A group of chronic anemias characterized by premature erythrocyte destruction. Spherocytes are not readily found, differentiating these anemias from hereditary spherocytosis.
Chylous	A body effusion that has a milky, opaque appearance due to the presence of lymph fluid and chylomicrons.
Circulating leukocyte pool	The population of neutrophils actively circulating within the peripheral blood stream.
Clonality	The presence of identical cells derived from a single progenitor. Can be detected by the identification of only one of the immunoglobulin light chains (kappa or lambda) on B cells or the presence of a population of cells with a common phenotype.
Clonogenic	Giving rise to a clone of cells.
Clot	Extravascular coagulation, whether occurring in vitro or in blood shed into the tissues or body cavities.
Clot retraction	The cohesion of a fibrin clot that requires adequate, functionally normal platelets. Retraction of the clot occurs over a period of time and results in the expression of serum and a firm mass of cells and fibrin.
Coagulation factors	Soluble inert plasma proteins that interact to form fibrin after an injury.
Cobalamin	A cobalt-containing complex that is common to all subgroups of the vitamin B ₁₂ group.
Codocytes	See target cell.

Hematology

Cofactor	Coagulation factors V and VII function as cofactors. Required for the conversion of specific zymogens to the active enzyme form.
Cold agglutinin disease	Condition associated with the presence of cold-reacting autoantibodies (IgM) directed against erythrocyte surface antigens. This causes clumping of the red cells at room or lower temperatures.
Colony forming unit	A visible aggregation (seen in vitro) of cells that developed from a single stem cell.
Colony stimulating factor	Cytokine that stimulates the growth of immature leukocytes in the bone marrow.
Committed/progenitor cells	Parent or ancestor cells that differentiate into one cell line.
Common coagulation pathway	One of the three interacting pathways in the coagulation cascade. The common pathway includes three rate-limiting steps: (1) activation of factor X by the intrinsic and extrinsic pathways, (2) conversion of prothrombin to thrombin by activated factor X, and (3) cleavage of fibrinogen to fibrin.
Compensated hemolytic disease	A disorder in which the erythrocyte life span is decreased but the bone marrow is able to increase erythropoiesis enough to compensate for the decreased erythrocyte life span; anemia does not develop.
Complement	Any of the eleven serum proteins that when sequentially activated causes lysis of the cell membrane.

Hematology

Complete blood count (CBC)	A hematology screening test that includes the white blood cell (WBC) count, red blood cell (RBC) count, hemoglobin, hematocrit, and often, platelet count. It may also include red cell indices.
Congenital	Present at birth.
Congenital Heinz body hemolytic anemia	Inherited disorder characterized by anemia due to decreased erythrocyte lifespan. Erythrocyte hemolysis results from the precipitation of hemoglobin in the form of heinz bodies, which damages the cell membrane and causes cell rigidity.
Contact group	A group of coagulation factors in the intrinsic pathway that is involved with the initial activation of the coagulation system and requires contact with a negatively charged surface for activity. These factors include factors XII, XI, prekallikrein, and high molecular weight kininogen.
Continuous flow analysis	An automated method of analyzing blood cells that allows measurement of cellular characteristics as the individual cells flow singly through a laser beam.
Contour gating	Subclassification of cell populations based on two characteristics such as size (x-axis) and nuclear density (y-axis) and the frequency (z-axis) of that characterized cell type. This information is used to create a three-dimensional plot. A line is drawn along the valley between two peaks to separate two cell populations.

Hematology

Correlation coefficient (r)	Determines the distribution of data about the estimated linear regression line.
Coverglass smear	Blood smear prepared by placing a drop of blood in the center of one coverglass, then placing a second coverglass on top of the blood at a 45° angle to the first coverglass. The two coverglasses are pulled apart, creating two coverglass smears.
Cryopreservation	The maintaining of the viability of cells by storing at very low temperatures.
Cryosupernatant	Product that lacks large vwf multimers that are present in fresh frozen plasma, yet still contains the vWf cleaving protease missing in thrombotic thrombocytopenic purpura (TTP) patients.
Cyanosis	Develops as a result of excess deoxygenated hemoglobin in the blood, resulting in a bluish color of the skin and mucous membranes.
Cytochemistry	Chemical staining procedures used to identify various constituents (enzymes and proteins) within white blood cells. Useful in differentiating blasts in acute leukemia, especially when morphologic differentiation on romanowsky stained smears is impossible.
Cytokine	Protein produced by many cell types that modulates the function of other cell types; cytokines include interleukins, colony stimulating factors, and interferons.
Cytoplasm	The protoplasm of a cell outside the nucleus.
Deep vein thrombosis (DVT)	Formation of a thrombus, or blood clot, in the deep veins (usually a leg vein).

Hematology

Delayed bleeding	A symptom of severe coagulation factor disorders in which a wound bleeds a second time after initial stoppage of bleeding. This occurs because the primary hemostatic plug is not adequately stabilized by the formation of fibrin.
Dense bodies	Platelet storage granules containing nonmetabolic ADP, calcium, and serotonin along with other compounds that are released into an injured area.
Deoxyhemoglobin	Hemoglobin without oxygen.
Direct antiglobulin test (DAT)	A laboratory test used to detect the presence of antibody and/or complement that is attached to the erythrocyte. The test uses antibody directed against human immunoglobulin and/or complement.
Disseminated intravascular coagulation (DIC)	A complex condition in which the normal coagulation process is altered by an underlying condition resulting in complications such as thrombotic occlusion of vessels, bleeding, and ultimately organ failure. DIC is initiated by damage to the endothelial lining of vessels.
Döhle bodies	An oval aggregate of rough endoplasmic reticulum that stains light gray blue (with Romanowsky stain) found within the cytoplasm of neutrophils and eosinophils. It is associated with severe bacterial infection, pregnancy, burns, cancer, aplastic anemia, and toxic states.

Hematology

Donath-Landsteiner antibody	A biphasic IgG antibody associated with paroxysmal cold hemoglobinuria. The antibody reacts with erythrocytes in capillaries at temperatures below 15°C and fixes complement to the cell membrane. Upon warming, the terminal complement components on erythrocytes are activated, causing cell hemolysis.
Downey cell	An outdated term used to describe morphologic variations of the reactive lymphocyte.
Drug-induced hemolytic anemia	Hemolytic anemia precipitated by ingestion of certain drugs. The process may be immune mediated or nonimmune mediated.
Dutcher bodies	Intranuclear membrane bound inclusion bodies found in plasma cells. The body stains with periodic acid-schiff (PAS) indicating it contains glycogen or glycoprotein. Appearance is finely distributed chromatin, nucleoli, or intranuclear inclusions.
Dysfibrinogenemia	A hereditary condition in which there is a structural alteration in the fibrinogen molecule.
Dyshematopoiesis	Abnormal formation and/or development of blood cells within the bone marrow.
Dysplasia	Abnormal cell development.
Dyspoiesis	Abnormal development of blood cells frequently characterized by asynchrony in nuclear to cytoplasmic maturation and/or abnormal granule development.
Echinocyte	A spiculated erythrocyte with short, equally spaced projections over the entire outer surface of the cell.

Hematology

Edematous	Refers to the swelling of body tissues due to the accumulation of tissue fluid.
Effector lymphocytes	Antigen stimulated lymphocytes that mediate the efferent arm of the immune response.
Effusion	Abnormal accumulation of fluid.
Elliptocyte	An abnormally shaped erythrocyte. The cell is an oval to elongated ellipsoid with a central area of pallor and hemoglobin at both ends; also known as ovalocyte, pencil cell, or cigar cell.
Embolism	The blockage of an artery by embolus, usually by a portion of blood clot but can be other foreign matter, resulting in obstruction of blood flow to the tissues.
Embolus	A piece of blood clot or other foreign matter that circulates in the blood stream and usually becomes lodged in a small vessel obstructing blood flow.
Endomitosis	Nuclear DNA synthesis without cytoplasmic division.
Endothelial cells	Flat cells that line the cavities of the blood and lymphatic vessels, heart, and other related body cavities.

Hematology

Eosinophil

A mature granulocyte cell characterized by the presence of large acidophilic granules. These granules are pink to orange pink with romanowsky stains. The cell is 12—17 μm in diameter, and the nucleus has 2—3 lobes.

Granules contain acid phosphatase, glycuronidase cathepsins, ribonuclease, arylsulfatase, peroxidase, phospholipids, and basic proteins. Eosinophils have a concentration of less than $0.45 \times 10^9/\text{L}$ in the peripheral blood. The cell membrane has receptors for IgE and histamine.

Eosinophilia

An increase in the concentration of eosinophils in the peripheral blood ($>0.5 \times 10^9/\text{L}$).

Associated with parasitic infection, allergic conditions, hypersensitivity reactions, cancer, and chronic inflammatory states.

Erythroblastic island

A composite of erythroid cells in the bone marrow that surrounds a central macrophage. These groups of cells are usually disrupted when the bone marrow smears are made but may be found in erythroid hyperplasia. The central macrophage is thought to transfer iron to the developing cells. The least mature cells are closest to the center of the island and the more mature cells on the periphery.

Hematology

- Erythroblastosis fetalis** Hemolytic anemia occurring in newborns as a result of fetal-maternal blood group incompatibility involving the Rh factor of ABO blood groups. It is caused by an antigen—antibody reaction in the newborn when maternal antibodies traverse the placenta and attach to antigens on the fetal cells.
- Erythrocyte** Red blood cell (RBC) that has matured to the nonnucleated stage. The cell is about 7 μm in diameter. It contains the respiratory pigment hemoglobin, which readily combines with oxygen to form oxyhemoglobin. The cell develops from the pluripotential stem cell in the bone marrow under the influence of the hematopoietic growth factor, erythropoietin, and is released to the peripheral blood as a reticulocyte. The average life span is about 120 days, after which the cell is removed by cells in the mononuclear-phagocyte system. The average concentration is about $5 \times 10^{12}/\text{L}$ for males and $4.5 \times 10^{12}/\text{L}$ for females.
- Erythrocytosis** An abnormal increase in the number of circulating erythrocytes as measured by the erythrocyte count, hemoglobin, or hematocrit.
- Erythrophagocytosis** Phagocytosis of an erythrocyte by a histiocyte; the erythrocyte can be seen within the cytoplasm of the histiocyte as a pink globule or, if digested, as a clear vacuole on stained bone marrow or peripheral blood smears.
- Erythropoiesis** Formation and maturation of erythrocytes in the bone marrow; it is under the influence of the hematopoietic growth factor, erythropoietin.

Hematology

Erythropoietin	A hormone secreted by the kidney that regulates erythrocyte production by stimulating the stem cells of the bone marrow to mature into erythrocytes. Its primary effect is on the committed stem cell, CFU-E.
Essential thrombocythemia	A myeloproliferative disorder affecting primarily the megakaryocytic element in the bone marrow. There is extreme thrombocytosis in the blood (usually $>1,000 \times 10^9/L$). Also called primary thrombocythemia, hemorrhagic thrombocythemia, and megakaryocytic leukemia.
Evan's syndrome	A condition characterized by a warm autoimmune hemolytic anemia and concurrent severe thrombocytopenia.
Extracellular matrix	Noncellular components of the hematopoietic microenvironment in the bone marrow.
Extramedullary erythropoiesis	Red blood cell production occurring outside the bone marrow.
Extramedullary hematopoiesis	The formation and development of blood cells at a site other than the bone marrow.
Extravascular	Occurring outside of the blood vessels.
Extrinsic pathway	One of the three interacting pathways in the coagulation cascade. The extrinsic pathway is initiated when tissue factor comes into contact with blood and forms a complex with factor VII. The complex activates factor X. The term <i>extrinsic</i> is used because the pathway requires a factor extrinsic to blood, tissue factor.
Extrinsic Xase	A complex of tissue factor and factor VIIa that forms when a vessel is injured.

Hematology

Exudate	Effusion that is formed by increased vascular permeability and/or decreased lymphatic resorption. This indicates a true pathologic state in the anatomic region, usually either infection or tumor.
FAB classification	The current internationally accepted scheme for the classification of the acute leukemias. It is based on a combination of bright-light microscopy and cytochemical testing. (FAB = French-American-British)
Factor V Leiden	A mutant form of factor V in which Arg 506 is replaced with Gln. This makes the molecule resistant to activated protein C.
Factor VIII:C assay	A method that determines the amount of factor VIII.
Factor VIII concentrate	A lyophilized preparation of concentrated factor VIII used for replacement therapy of factor VIII in patients with hemophilia A.
Factor VIII inhibitor	An IgG immunoglobulin with antibody specificity to factor VIII. The inhibitor inactivates the factor. The antibodies are time and temperature dependent. Factor VIII inhibitors are associated with hemophilia.
Factor VIII/vWf complex	The plasma form of vWf associated with factor VIII.
Faggot cell	A cell in which there is a large collection of Auer rods and/or phi bodies.
False rejection	Rejection of a control run that is not truly out of control. The result falling outside the control limits or violating a Westgard rule is due to the inherent imprecision of the test method.

Hematology

Ferritin	An iron-phosphorus-protein compound formed when iron complexes with the protein apoferritin; it is a storage form of iron found primarily in the bone marrow, spleen, and liver. Small amounts can be found in the peripheral blood proportional to that found in the bone marrow.
Fibrin degradation products (FDP)	The breakdown products of fibrin or fibrinogen that are produced when plasmin's proteolytic action cleaves these molecules. The four main products are fragments X, Y, D, and E. The presence of fibrin degradation products is indicative of either fibrinolysis or fibrinogenolysis.
Fibrin monomer	The structure resulting when thrombin cleaves the A and B fibrinopeptides from the α and β chains of fibrinogen.
Fibrinogen group	A group of coagulation factors that are consumed during the formation of fibrin and therefore absent from serum. Includes factors I, V, VIII, and XIII. Also called the consumable group.
Fibrinolysis	Breakdown of fibrin.
Fibrin polymer	A complex of covalently bonded fibrin monomers. The bonds between glutamine and lysine residues are formed between terminal domains of γ chains and polar appendages of α chains of neighboring residues.
Fibronectin	Extracellular-matrix glycoprotein capable of binding heparin.
Fibrosis	Abnormal formation of fibrous tissue.

Hematology

Flame cell	A plasma cell with reddish purple cytoplasm. The red tinge is caused by the presence of a glycoprotein and the purple by ribosomes.
Flow chamber	The specimen handling area of a flow cytometer where cells are forced into single file and directed in front of the laser beam.
Fluorochrome	Molecules that are excited by light of one wavelength and emit light of a different wavelength.
Forward light scatter	Laser light scattered in a forward direction in a flow cytometer. Forward light scatter is related to particle size (e.g., large cells produce more forward scatter).
Free erythrocyte protoporphyrin (FEP)	Protoporphyrin within the erythrocyte that is not complexed with iron. The concentration of FEP increases in iron-deficient states. It is now known that in the absence of iron, erythrocyte protoporphyrin combines with zinc to form zinc protoporphyrin (ZPP).
Gene rearrangement	A process in which segments of DNA are cut and spliced to produce new DNA sequences. During normal lymphocyte development, rearrangement of the immunoglobulin genes and the T cell receptor genes results in new gene sequences that encode the antibody and surface antigen receptor proteins necessary for immune function.

Hematology

Genome	The total aggregate of inherited genetic material. In humans, the genome consists of 3 billion base pairs of dna divided among 46 chromosomes, including 22 pairs of autosomes numbered 1—22 and the two sex chromosomes.
Genotype	The genetic constitution of an individual, often referring to a particular gene locus.
Glanzmann's thrombasthenia	A rare hereditary platelet disorder characterized by a genetic mutation in one of the genes coding for the glycoproteins IIb or IIIa and resulting in the inability of platelets to aggregate.
Globin	The protein portion of the hemoglobin molecule.
Glucose-6-phosphate-dehydrogenase (G6PD)	An enzyme within erythrocytes that is important in carbohydrate metabolism. It dehydrogenates glucose-6-phosphate to form 6-phosphogluconate in the hexose monophosphate shunt. This reaction produces NADPH from NADP. This provides the erythrocyte with reducing power, protecting the cell from oxidant injury.
Glutathione	A tripeptide that takes up and gives off hydrogen and prevents oxidant damage to the hemoglobin molecule. Deficiency of this enzyme is associated with hemolytic anemia.
Glycoprotein Ib	A glycoprotein of the platelet surface that contains the receptor for von Willebrand factor and is critical for initial adhesion of platelets to collagen after an injury.

Hematology

Glycoprotein IIb/IIIa complex	A complex of membrane proteins on the platelet surface that is functional only after activation by agonists and then becomes a receptor for fibrinogen and von Willebrand factor. It is essential for platelet aggregation.
Glycosylated hemoglobin	Hemoglobin that has glucose irreversibly attached to the terminal amino acid of the beta chains. Also called HbA _{1c} .
Gower hemoglobin	An embryonic hemoglobin detectable in the yolk sac for up to eight weeks gestation. It is composed of two zeta (ζ) chains and two epsilon (ε) chains.
Granulocytopenia	A decrease in granulocytes below $2 \times 10^9/L$.
Granulocytosis	An increase in granulocytes above $6.8 \times 10^9/L$. Usually seen in bacterial infections, inflammation, metabolic intoxication, drug intoxication, and tissue necrosis.
Granulomatous	A distinctive pattern of chronic reaction in which the predominant cell type is an activated macrophage with epithelial-like (epithelioid) appearance.
Gray platelet syndrome	A rare hereditary platelet disorder characterized by the lack of alpha granules.
Hairy cell	The neoplastic cell of hairy cell leukemia characterized by circumferential, cytoplasmic, hairlike projections.
Ham test	A specific laboratory test for paroxysmal nocturnal hemoglobinuria (PNH). When erythrocytes from a patient with PNH are incubated in acidified serum, the cells lyse due to complement activation. Also called the acid-serum lysis test.

Hematology

Haptoglobin	Serum α_2 -globulin glycoprotein that transports free plasma hemoglobin to the liver.
Heinz bodies	An inclusion in the erythrocyte composed of denatured or precipitated hemoglobin. Appears as purple staining body on supravivally (crystal violet) stained smears.
Helmet cell	Abnormally shaped erythrocyte with one or several notches and projections on either end that look like horns. Also called keratocyte and horn-shaped cells. The shape is caused by trauma to the erythrocyte.
Hematocrit	The packed cell volume of erythrocytes in a given volume of blood following centrifugation of the blood. Expressed as a percentage of total blood volume or as liter of erythrocytes per liter of blood (L/L). Also, referred to as packed cell volume (PCV).
Hematogones	Precursor B lymphocytes present normally in the bone marrow.
Hematology	The study of formed cellular blood elements.
Hematoma	A localized collection of blood under the skin or in other organs caused by a break in the wall of a blood vessel.
Hematopoiesis	The production and development of blood cells normally occurring in the bone marrow under the influence of hematopoietic growth factors.
Hematopoietic microenvironment	Specialized, localized environment in hematopoietic organs that supports the development of hematopoietic cells.

Hematology

Hematopoietic progenitor cell	Hematopoietic precursor cell developmentally located between stem cells and the morphologically recognizable blood precursor cells; includes multilineage and unilineage cell types.
Hematopoietic stem cell	Hematopoietic precursor cell capable of giving rise to all lineages of blood cells.
Heme	The nonprotein portion of hemoglobin and myoglobin that contains iron nestled in a hydrophobic pocket of a porphyrin ring (ferroprotoporphyrin). It is responsible for the characteristic color of hemoglobin.
Hemochromatosis	A clinical condition resulting from abnormal iron metabolism. Characterized by accumulation of iron deposits in body tissues.
Hemoconcentration	Refers to the increased concentration of blood components due to loss of plasma from the blood.
Hemoglobin	An intracellular erythrocyte protein that is responsible for the transport of oxygen and carbon dioxide between the lungs and body tissues.
Hemoglobin distribution width	A measure of the distribution of hemoglobin within an erythrocyte population. It is derived from the hemoglobin histogram generated by the Bayer/Technicon instruments.
Hemoglobin electrophoresis	Method of identifying hemoglobins based on differences in their electrical charges.
Hemoglobinemia	Presence of excessive hemoglobin in the plasma.
Hemoglobinopathy	Disease that results from an inherited abnormality of the structure or synthesis of the globin portion of the hemoglobin molecule.

Hematology

Hemoglobinuria	The presence of hemoglobin in the urine.
Hemolysis	A destruction of erythrocytes resulting in the release of hemoglobin. In hemolytic anemia this term refers to the premature destruction of erythrocytes.
Hemolytic anemia	A disorder characterized by a decreased erythrocyte concentration due to premature destruction of the erythrocyte.
Hemolytic disease of the newborn (HDN)	An alloimmune disease characterized by fetal red blood cell destruction as a result of incompatibility between maternal and fetal blood groups.
Hemolytic transfusion reaction	Interaction of foreign (nonself) erythrocyte antigens and plasma antibodies due to the transfusion of blood. There are two types of transfusion reactions: immediate (within 24 hours) or delayed (occurring 2 to 14 days after transfusion).
Hemopexin	A plasma glycoprotein (β -globulin) that binds the heme molecule in plasma in the absence of haptoglobin.
Hemophilia A	A sex-linked (X-linked) hereditary hemorrhagic disorder caused by a genetic mutation of the gene coding for coagulation factor VIII.
Hemophilia B	A sex-linked (X-linked) hereditary hemorrhagic disorder caused by a genetic mutation of the gene coding for coagulation factor IX.
Hemorrhage	Loss of a large amount of blood, either internally or externally.

Hematology

Hemorrhagic disease of the newborn	A severe bleeding disorder in the first week of life caused by deficiencies of the vitamin K-dependent clotting factors due to vitamin K deficiency.
Hemosiderin	A water insoluble, heterogeneous iron—protein complex found primarily in the cytoplasm of cells (normoblasts and histocytes in the bone marrow, liver, and spleen); the major long-term storage form of iron. Readily visible microscopically in unstained tissue specimens as irregular aggregates of golden yellow to brown granules. It may be visualized with prussian-blue stain as blue granules. The granules are normally distributed randomly or diffuse.
Hemosiderinuria	Presence of iron (hemosiderin) in the urine; result of intravascular hemolysis and disintegration of renal tubular cells.
Hemostasis	The localized, controlled process that results in arrest of bleeding after an injury.
Heparin	A polysaccharide that inhibits coagulation of blood by preventing thrombin from cleaving fibrinogen to form fibrin. Commercially available in the form of a sodium salt for therapeutic use as an anticoagulant.
Heparin induced thrombocytopenia (HIT)	Thrombocytopenia associated with heparin therapy in some patients.

Hematology

Hereditary elliptocytosis An autosomal dominant condition characterized by the presence of increased numbers of elongated and oval erythrocytes. The abnormal shape is due to a horizontal interaction defect with abnormal spectrin, deficiency or defect in band 4.1, or deficiency of glycophorin C and abnormal band 3.

Hereditary pyropoikilocytosis (HPP) A rare but severe hemolytic anemia inherited as an autosomal recessive disorder. Characterized by marked erythrocyte fragmentation. The defect is most likely a spectrin abnormality in the erythrocyte cytoskeleton.

Hereditary spherocytosis A chronic hemolytic anemia caused by an inherited erythrocyte membrane disorder. The vertical interaction defect is most commonly due to a combined spectrin and ankyrin deficiency. The defect causes membrane instability and progressive membrane loss. Secondary to membrane loss, the cells become spherocytes and are prematurely destroyed in the spleen. The condition is usually inherited as an autosomal dominant trait.

Hereditary stomatocytosis A rare hemolytic anemia inherited in an autosomal dominant fashion. The erythrocyte membrane is abnormally permeable to sodium and potassium. The cell becomes overhydrated, resulting in the appearance of stomatocytes. The specific membrane abnormality has not been identified.

Hematology

- Hereditary xerocytosis** A hereditary disorder in which the erythrocyte is abnormally permeable to sodium and potassium, with an increased potassium efflux. The erythrocyte becomes dehydrated and appears as either target or spiculated cells. The cells are rigid and become trapped in the spleen.
- Hexose-monophosphate shunt** A metabolic pathway that converts glucose-6-phosphate to pentose phosphate. This pathway couples oxidative metabolism with the reduction of nicotinamide adenine dinucleotide-phosphate (NADPH) and glutathione. This provides the cell with reducing power and prevents injury by oxidants.
- Histogram** A graphical representation of the number of cells within a defined parameter such as size.
- Hodgkin lymphoma (disease)** Malignancy that most often arises in lymph nodes and is characterized by the presence of Reed-Sternberg cells and variants with a background of varying numbers of benign lymphocytes, plasma cells, histiocytes, and eosinophils. The origin of the malignant cell is still controversial.
- Homologous** Consists of two morphologically identical chromosomes that have identical gene loci, but may have different gene alleles as one member of a homologous pair is of maternal origin and the other is of paternal origin.
- Homozygous** Identical genes at a gene locus.

Hematology

Howell-Jolly bodies	Erythrocyte inclusion composed of nuclear remnants (DNA). On Romanowsky stained blood smears, it appears as a dark purple spherical granule usually near the periphery of the cell. Commonly associated with megaloblastic anemia and splenectomy.
Hydrops fetalis	A genetically determined hemolytic disease (thalassemia) resulting in production of an abnormal hemoglobin (hemoglobin Bart's, γ_4) that is unable to carry oxygen. No alpha(α)-globin chains are synthesized.
Hypercoagulable state	A condition associated with an imbalance between clot promoting and clot inhibiting factors. This leads to an increased risk of developing thrombosis.
Hypereosinophilic syndrome	A term used to describe a persistent blood eosinophilia over $1.5 \times 10^9/L$ with tissue infiltration and no apparent cause.
Hyperplasia	An increase in the number of cells per unit volume of tissue. This can be brought about by an increase in the number of cells replicating, by an increase in the rate of replication, or by prolonged survival of cells. The cells usually maintain normal size, shape, and function. The stimulus for the proliferation may be acute injury, chronic irritation, or prolonged, increased hormonal stimulation; in hematology, a hyperplastic bone marrow is one in which the proportion of hematopoietic cells to fat cells is increased.

Hematology

Hypersplenism	A disorder characterized by enlargement of the spleen and pancytopenia in the presence of a hyperactive bone marrow.
Hypocellularity	Decreased cellularity of hematopoietic precursors in the bone marrow.
Hypochromic	A lack of color; used to describe erythrocytes with an enlarged area of pallor due to a decrease in the cell's hemoglobin content. The mean corpuscular hemoglobin concentration (MCHC) and mean corpuscular hemoglobin (MCH) are decreased.
Hypofibrinogenemia	A condition in which there is an abnormally low fibrinogen level in the peripheral blood. It may be caused by a mutation in the gene controlling the production of fibrinogen or by an acquired condition in which fibrinogen is pathologically converted to fibrin.
Hypogammaglobulinemia	A condition associated with a decrease in resistance to infection as a result of decreased γ -globulins (immunoglobulins) in the blood.
Hypoplasia	A condition of underdeveloped tissue or organ usually caused by a decrease in the number of cells. A hypoplastic bone marrow is one in which the proportion of hematopoietic cells to fat cells is decreased.
Hypoproliferative	Decreased production of any cell type.
Hypoxia	A deficiency of oxygen to the cells.
Idiopathic	Pertains to disorders or diseases in which the pathogenesis is unknown.

Hematology

Idiopathic (or immune) thrombocytopenic purpura (ITP)	An acquired condition in which the platelets are destroyed by immune mechanisms faster than the bone marrow is able to compensate. Platelets are decreased.
Immature reticulocyte fraction (IRF)	An index of reticulocyte maturity provided by flow cytometry. The irf may be helpful in evaluating bone marrow erythropoietic response to anemia, monitoring anemia, and evaluating response to therapy.
Immune hemolytic anemia	An anemia that is caused by premature, immune mediated, destruction of erythrocytes. Diagnosis is confirmed by the demonstration of immunoglobulin (antibodies) and/or complement on the erythrocytes.
Immune response	Body's defense mechanism, which includes producing antibodies to foreign antigens.
Immunoblast	A T or B lymphocyte that is mitotically active as a result of stimulation by an antigen. The cell is morphologically characterized by a large nucleus with prominent nucleoli, a fine chromatin pattern, and abundant, deeply basophilic cytoplasm.
Immunocompetent	The ability to respond to stimulation by an antigen.
Immunoglobulin	Molecule produced by B lymphocytes and plasma cells that reacts with antigen. Consists of two pairs of polypeptide chains: two heavy and two light chains linked together by disulfide bonds. Also called an antibody.
Immunohistochemical stains	Application of stains using immunologic principles and techniques to study cells and tissues; usually a labeled antibody is used to detect antigens (markers) on a cell.

Hematology

Immunophenotyping	Identification of antigens using detection antibodies.
Immunosuppressed	The inability to produce antibodies to antigens.
Indirect antiglobulin test (IAT)	Laboratory test used to detect the presence of serum antibodies against specific erythrocyte antigens.
Ineffective erythropoiesis	Premature death of erythrocytes in the bone marrow preventing release into circulation.
Infectious lymphocytosis	An infectious, contagious disease of young children that may occur in epidemic form. The most striking hematologic finding is a leukocytosis of 40—50 X 10 ⁹ /L with 60—97% small, normal-appearing lymphocytes.
Infectious mononucleosis	A self-limiting lymphoproliferative disease caused by infection with Epstein-Barr virus (EBV). The leukocyte count is usually increased, which is related to an absolute lymphocytosis. Various forms of reactive lymphocytes are present. Serologic tests to detect the presence of heterophil antibodies are helpful in differentiating this disease from more serious diseases. Also known as the kissing disease.
Internal quality control program	Program designed to verify the validity of laboratory test results that is followed as part of the daily laboratory operations. Typically, monitored using Levey-Jennings plots and Westgard rules.
International Normalized Ratio (INR)	Method of reporting prothrombin time results when monitoring long-term oral anticoagulant therapy. Results are independent of the reagents and methods used.

Hematology

Intrinsic coagulation pathway	One of the three interacting pathways in the coagulation cascade. The intrinsic pathway is initiated by exposure of the contact coagulation factors (factors XII, XI, prekallikrein, and high molecular weight kininogen) with vessel subendothelial tissue. The intrinsic pathway activates factor X. The term <i>intrinsic</i> is used because all intrinsic factors are contained within the blood.
Intrinsic factor	A glycoprotein secreted by the parietal cells of the stomach that is necessary for binding and absorption of dietary vitamin B ₁₂ .
Intrinsic Xase	A complex of factors IXa, VIIIa, phospholipid, and calcium that assembles on membrane surfaces.
Irreversibly sickled cells (ISC)	Rigid cells that have been exposed to repeated sickling events and cannot revert to a normal discoid shape. They are ovoid or boat-shaped and have a high MCHC and low MCV.
Ischemia	Deficiency of blood supply to a tissue, caused by constriction of the vessel or blockage of the blood flow through the vessel.
Jaundice	Yellowing of the skin, mucous membranes, and the whites of the eye caused by accumulation of bilirubin.
Karyolysis	Destruction of the nucleus.
Karyorrhexis	Disintegration of the nucleus resulting in the irregular distribution of chromatin fragments within the cytoplasm.

Hematology

Keratocytes	Abnormally shaped erythrocytes with one or several notches and projections on either end that look like horns. Also called helmet cells and horn-shaped cells. The shape is caused by trauma to the erythrocyte.
Killer cell	Population of cytolytic lymphocytes identified by monoclonal antibodies. Involved in several activities such as resistance to viral infections, regulation of hematopoiesis, and activities against tumor cells.
Knizocytes	An abnormally shaped erythrocyte that appears on stained smears as a cell with a dark stick-shaped portion of hemoglobin in the center and a pale area on either end. The cell has more than two concavities.
L&H/popcorn cell	The neoplastic cell variant found in LP Hodgkin lymphoma characterized by a delicate multilobated nucleus and multiple, small nucleoli. The L&H cell has a B cell phenotype: LCA+ (leukocyte common antigen), CD20+, CD 15—.
Lacunar cell	The neoplastic cell variant found in NS Hodgkin lymphoma characterized by abundant pale staining cytoplasm. Characterized by cytoplasmic clearing and delicate, multilobated nuclei.
Large granular lymphocyte	Null cells with a low nuclear-to-cytoplasmic ratio, pale blue cytoplasm, and azurophilic granules. They do not adhere to surfaces or phagocytose.

Hematology

Leptocyte

An abnormally shaped erythrocyte that is thin and flat with hemoglobin at the periphery. It is usually cup-shaped.

Leukemia

A progressive, malignant disease of the hematopoietic system characterized by unregulated, clonal proliferation of the hematopoietic stem cells. The malignant cells eventually replace normal cells. It is generally classified into chronic or acute, and lymphocytic or myelocytic.

Leukemic hiatus

A gap in the normal maturation pyramid of cells, with many blasts and some mature forms but very few intermediate maturational stages.

Eventually, the immature neoplastic cells fill the bone marrow and spill over into the peripheral blood, producing leukocytosis (e.g., acute leukemia).

Leukemoid reaction

A transient, reactive condition resulting from certain types of infections or tumors characterized by an increase in the total leukocyte count to greater than $25 \times 10^9/L$ and a shift to the left in leukocytes (usually granulocytes).

Leukocyte

White blood cell (WBC). There are five types of leukocytes: neutrophils, eosinophils, basophils, lymphocytes, and monocytes. The function of these cells is defense against infection and tissue damage. The normal reference range for total leukocytes in peripheral blood is 3.5—11.0 $\times 10^9/L$.

Hematology

Leukocyte alkaline phosphatase (LAP)	An enzyme present within the specific (secondary) granules of granulocytes (from the myelocyte stage onward). Useful in distinguishing leukemoid reaction/reactive neutrophilia (high LAP) from chronic myelogenous leukemia (low LAP).
Leukocytosis	An increase in wbc's in the peripheral blood; WBC count over $11 \times 10^9/L$.
Leukoerythroblastic reaction	A condition characterized by the presence of nucleated erythrocytes and a shift-to-the-left in neutrophils in the peripheral blood. Often associated with myelophthisis.
Leukopenia	Decrease in leukocytes below $4 \times 10^9/L$.
Leukopoiesis	The production of leukocytes.
Lupus-like anticoagulant	A circulating anticoagulant that arises spontaneously in patients with a variety of conditions (originally found in patients with lupus erythematosus) and directed against phospholipid components of the reagents used in laboratory tests for clotting factors. See antiphospholipid antibody.
Lymphadenopathy	Abnormal enlargement of lymph nodes.
Lymphoblast	A lymphocytic precursor cell found in the bone marrow. The cell is 10—20 μm in diameter and has a high nuclear/cytoplasmic ratio. The nucleus has a fine (lacy) chromatin pattern with one or two nucleoli. The cytoplasm is agranular and scant. It stains deep blue with romanowsky stain. The cell contains terminal deoxynucleotidyltransferase (TdT) but no peroxidase, lipid, or esterase.

Hematology

Lymphocyte

A mature leukocyte with variable size depending on the state of cellular activity and amount of cytoplasm. The nucleus is usually round with condensed chromatin and stains deep, dark purple with romanowsky stains. The cytoplasm stains a light blue. Nucleoli are usually not visible. A few azurophilic granules may be present. These cells interact in a series of events that allow the body to attack and eliminate foreign antigen. Lymphocytes have a peripheral blood concentration in adults from 1.5 to $4.0 \times 10^9/L$ (20—40% of leukocytes). The concentration in children less than 10 years old is higher.

Lymphocytic leukemoid reaction

Characterized by an increased lymphocyte count with the presence of reactive or immature-appearing lymphocytes. Reactions are associated with whooping cough, chickenpox, infectious mononucleosis, infectious lymphocytosis, and tuberculosis.

Lymphocytopenia

A decrease in the concentration of lymphocytes in the peripheral blood ($<1.0 \times 10^9/L$). Also called lymphopenia.

Lymphocytosis

An increase in peripheral blood lymphocyte concentration ($>4 \times 10^9/L$ in adults or $>9 \times 10^9/L$ in children).

Lympho-epithelial lesion

Infiltration of epithelium by groups of lymphocytes. Infiltration of mucosal epithelium by neoplastic lymphocytes is characteristic of MALT lymphoma.

Lymphoid follicle

Sphere of B cells within lymphatic tissue.

Hematology

Lymphokines	Substances released by sensitized lymphocytes and responsible for activation of macrophages and other lymphocytes.
Lymphoma	Malignant proliferation of lymphocytes. Most cases arise in lymph nodes, but it can begin at many extranodal sites. The lymphomas are classified as to B or T cell and low, intermediate, or high grade.
Lymphoma classification	Division (grading) of lymphomas into groups, each with a similar clinical course and response to treatment. Current schemes use a combination of morphologic appearance, phenotype, and genotype.
Lypholized	Serum or plasma sample that has been freeze-dried. Sample is reconstituted with a diluent, typically distilled or deionized water.
Lysosomal granules	Granules containing lysosomal enzymes.
Lysosome	Membrane bound sacs in the cytoplasm that contain various hydrolytic enzymes.
Macrocyte	An abnormally large erythrocyte. The MCV is >100 fl. Oval macrocytes are characteristically seen in megaloblastic anemia.
Macro-ovalocyte	An abnormally large erythrocyte with an oval shape. This cell is characteristically seen in megaloblastic anemia.
Macrophage	A large tissue cell (10—20 μm) derived from monocytes. The cell secretes a variety of products that influence the function of other cells. It plays a major role in both nonspecific and specific immune responses.

Hematology

Malignant neoplasm	A clone of identical, anaplastic (dedifferentiated), proliferating cells. Malignant cells can metastasize.
Marginating pool	The population of neutrophils that are attached to or marginated along the vessel walls and not actively circulating. This is about one-half the total pool of neutrophils in the vessels.
Maturation	A process of attaining complete development of the cell.
Maturation index	A mathematical expression that attempts to separate AML-M5 and AML-M1 with and without maturation.
Mean cell hemoglobin (MCH)	An indicator of the average weight of hemoglobin in individual erythrocytes reported in picograms. The reference interval for MCH is 26—34 pg. This parameter is calculated from the hemoglobin and erythrocyte count: $MCH (pg) = \frac{\text{Hemoglobin (g/dl)}}{\text{Erythrocyte count (X } 10^{12}/L)} \times 10$.
Mean cell hemoglobin concentration (MCHC)	A measure of the average concentration of hemoglobin in grams per deciliter of erythrocytes. The reference interval is 32—36 g/dl. The MCHC is useful when evaluating erythrocyte hemoglobin content on a stained smear. This parameter will correlate with the extent of chromasia exhibited by the stained cells and is calculated from the hemoglobin and hematocrit. $MCHC (g/dl) = \frac{\text{hemoglobin (g/dl)}}{\text{hematocrit (L/L)}}$.

Hematology

- Mean cell volume (MCV)** An indicator of the average volume of individual erythrocytes reported in femtoliters. The reference interval for MCV is 80—100 fl. This parameter is useful when evaluating erythrocyte morphology on a stained blood smear. The MCV usually will correlate with the diameter of the erythrocytes observed microscopically. The MCV can be calculated from the hematocrit and erythrocyte count: $MCV \text{ (fl)} = \frac{\text{hematocrit (L/L)}}{\text{Erythrocyte count (X } 10^{12}/\text{L)}} \times 1000$.
- Mean platelet volume** Mean volume of a platelet population; analogous to the MCV of erythrocytes.
- Medullary hematopoiesis** Blood cell production and development in the bone marrow.
- Megakaryocyte** A large cell found within the bone marrow characterized by the presence of large or multiple nuclei and abundant cytoplasm. Gives rise to the blood platelets.
- Megaloblastic** Asynchronous maturation of any nucleated cell type characterized by delayed nuclear development in comparison to the cytoplasmic development. The abnormal cells are large and are characteristically found in pernicious anemia or other megaloblastic anemia.
- Metamyelocyte** A granulocytic precursor cell normally found in the bone marrow. The cell is 10—15 μm in diameter. The cytoplasm stains pink and there is a predominance of specific granules. The nucleus is indented with a kidney-bean shape. The nuclear chromatin is condensed and stains dark purple.

Hematology

Methemoglobin	Hemoglobin with iron that has been oxidized to the ferric state (Fe^{+++}); it is incapable of combining with oxygen.
Microangiopathic hemolytic anemia (MAHA)	Any hemolytic process that is caused by prosthetic devices or lesions of the small blood vessels.
Microcyte	An abnormally small erythrocyte. The MCV is typically less than 80 fl and its diameter less than 7.0 μm on a stained smear.
Microenvironment	A unique environment in the bone marrow where orderly proliferation and differentiation of precursor cells take place.
Micromegakaryocyte	Small, abnormal megakaryocyte sometimes found in the peripheral blood in MDS and the myeloproliferative syndromes.
Mixed lineage acute leukemia	An acute leukemia that has both myeloid and lymphoid populations present or blasts that possess myeloid and lymphoid markers on the same cell.
Monoblast	The monocytic precursor cells found in bone marrow. It is about 14—18 μm in diameter with abundant agranular, blue gray cytoplasm. The nucleus may be folded or indented. The chromatin is finely dispersed and several nucleoli are visible. The monoblast has nonspecific esterase activity that is inhibited by sodium fluoride.
Monoclonal gammopathies	An alteration in immunoglobulin production that is characterized by an increase in one specific class of immunoglobulin.

Hematology

Monocyte

A mature leukocyte found in bone marrow or peripheral blood. Its morphology depends upon its activity. The cell ranges in size from 12—30 μm with an average of 18 μm . The blue-gray cytoplasm is evenly dispersed with fine dust-like granules. There are two types of granules. One contains peroxidase, acid phosphatase, and arylsulfatase. Less is known about the content of the other granule. The nuclear chromatin is loose and linear forming a lacy pattern. The nucleus is often irregular in shape.

Monocyte-macrophage system

A collection of monocytes and macrophages, found both intravascularly and extravascularly. Plays a major role in initiating and regulating the immune response.

Monocytopenia

A decrease in the concentration of circulating monocytes ($<0.2 \times 10^9/\text{L}$).

Monocytosis

An increase in the concentration of circulating monocytes ($>1.0 \times 10^9/\text{L}$).

Morulae

Basophilic, irregularly shaped granular, cytoplasmic inclusions found in leukocytes in an infectious disease called ehrlichiosis.

Mosaic

Occurs in the embryo shortly after fertilization, resulting in congenital aberrations in some cells and some normal cells.

Hematology

Mott cell	Pathologic plasma cell whose cytoplasm is filled with colorless globules. These globules most often contain immunoglobulin (Russell bodies). The globules form as a result of accumulation of material in the RER, SER, or Golgi complex due to an obstruction of secretion. The cell is associated with chronic plasmocyte hyperplasia, parasitic infection, and malignant tumors. Also called grape cells.
Multimer analysis	An analysis that determines the structure of vWf multimers.
Multiple myeloma	Plasma cell malignancy characterized by increased plasma proteins.
Mutation	Any change in the nucleotide sequence of DNA. In instances where large sequences of nucleotides are missing, the alteration is referred to as a deletion.
Myeloblast	The first microscopically identifiable granulocyte precursor. It is normally found in the bone marrow. The cell is large (15—20 μm) with a high nuclear/cytoplasmic ratio. The nucleus has a fine chromatin pattern with a nucleoli. There is moderate amount of blue, agranular cytoplasm.
Myelocyte	A granulocytic precursor cell normally found in the bone marrow. The cell is 12—18 μm in diameter with a pinkish granular cytoplasm. There are both primary and secondary granules present.

Hematology

Myelodysplastic syndromes (MDS)

A group of primary neoplastic pluripotential stem cell disorders characterized by one or more cytopenias in the peripheral blood together with prominent maturation abnormalities (dysplasia) in the bone marrow.

Myelofibrosis with myeloid metaplasia

A myeloproliferative disorder characterized by excessive proliferation of all cell lines as well as progressive bone marrow fibrosis and blood cell production at sites other than the bone marrow, such as the liver and spleen. Also called agnogenic myeloid metaplasia and primary myelofibrosis.

Myeloid-to-erythroid ratio (M:E ratio)

The ratio of granulocytes and their precursors to nucleated erythroid precursors derived from performing a differential count on bone marrow nucleated hematopoietic cells. Monocytes and lymphocytes are not included. The normal ratio is usually between 1.5:1 and 3.5:1, reflecting a predominance of myeloid elements.

Myeloid/NK cell acute leukemia

An acute leukemia in which the neoplastic cells coexpress myeloid antigens (CD33, CD13, and/or CD15) and NK cell-associated antigens (CD56, CD11b), while they lack HLADR and T lymphocyte associated antigens CD3 and CD8.

Myeloperoxidase

An enzyme present in the primary granules of myeloid cells including neutrophils, eosinophils, and monocytes.

Myelophthisis

Replacement of normal hematopoietic tissue in bone marrow by fibrosis, leukemia, or metastatic cancer cells.

Hematology

Myeloproliferative disorders (MPD)	A group of neoplastic clonal disorders characterized by excess proliferation of one or more cell types in the bone marrow.
National Committee for Clinical Laboratory Standards (NCCLS)	National agency that establishes laboratory standards.
Necrosis	Pathologic cell death resulting from irreversible damage; "cell murder."
Neonatal idiopathic thrombocytopenic purpura (neonatal ITP)	A form of ITP that occurs in newborns due to the transfer of maternal alloantibodies.
Neoplasm	Abnormal formation of new tissue (such as a tumor) that serves no useful purpose. May be benign or malignant.
Neutropenia	A decrease in neutrophils below $2 \times 10^9/L$.
Neutrophil	A mature white blood cell with a segmented nucleus and granular cytoplasm. These cells constitute the majority of circulating leukocytes. The absolute number varies between 2.0 and $6.8 \times 10^9/L$. They are also called granulocytes or segs.
Neutrophilia	An increase in neutrophils over $6.8 \times 10^9/L$. Seen in bacterial infections, inflammation, metabolic intoxication, drug intoxication, and tissue necrosis.
Nonspecific granules	Large, blue-black granules found in promyelocytes. The granules have a phospholipid membrane and stain positive for peroxidase.

Hematology

Nonthrombocytopenic purpura	A condition in which platelets are normal in number but purpura are present; purpura is considered to be caused by damage to the blood vessels.
Normal pooled plasma	Platelet-poor plasma collected from at least 20 individuals for coagulation testing. Plasmas should give pt and aptt results within the laboratory's reference interval. The plasma is pooled and used in mixing studies to differentiate a circulating inhibitor from a factor deficiency.
Normoblast	Nucleated erythrocyte precursor in the bone marrow. Also known as erythroblast.
Nuclear-cytoplasmic asynchrony	A condition in which the cellular nucleus matures slower than the cytoplasm, suggesting a disturbance in coordination. As a result, the nucleus takes on the appearance of a nucleus associated with a younger cell than its cytoplasmic development indicates. This is a characteristic of megaloblastic anemias.
Nuclear-to-cytoplasmic ratio (N:C ratio)	The ratio of the volume of the cell nucleus to the volume of the cell's cytoplasm. This is usually estimated as the ratio of the diameter of the nucleus to the diameter of the cytoplasm. In immature hematopoietic cells the N:C ratio is usually greater than in more mature cells. As the cell matures, the nucleus condenses and the cytoplasm expands.

Hematology

Nucleolus (pl: nucleoli)	A spherical body within the nucleus in which ribosomes are produced. It is not present in cells that are not synthesizing proteins or that are not in mitosis or meiosis. It stains a lighter blue than the nucleus with Romanowsky stains.
Nucleotide	The basic building block of DNA, composed of nitrogen base (A = adenine, T = thymine, G = guanine, or C = cytosine) attached to a sugar (deoxyribose) and a phosphate molecule.
Nucleus (pl: nuclei)	The characteristic structure in the eukaryotic cell that contains chromosomes and nucleoli. It is separated from the cytoplasm by a nuclear envelope. The structure stains deep bluish-purple with romanowsky stain. In young, immature hematopoietic cells, the nuclear material is open and dispersed in a lacy pattern. As the cell becomes mature, the nuclear material condenses and appears structureless. See large granular lymphocytes.
Null cell	
Oncogene	An altered gene that contributes to the development of cancer. Most oncogenes are altered forms of normal genes that function to regulate cell growth and differentiation. The normal gene counterpart is known as a proto-oncogene.
Optimal counting area	Area of the blood smear where erythrocytes are just touching but not overlapping; used for morphologic evaluation and identification of cells.

Hematology

Oral anticoagulant	A group of drugs (e.g., coumadin, warfarin) that prevent coagulation by inhibiting the activity of vitamin K. Vitamin K is required for the synthesis of functional prothrombin group coagulation factors.
Orthochromatic normoblast	A nucleated precursor of the erythrocyte that develops from the polychromatophilic normoblast. It is the last nucleated stage of erythrocyte development. The cell normally is found in the bone marrow.
Osmotic fragility	A laboratory procedure employed to evaluate the ability of erythrocytes to withstand different salt concentrations; this is dependent upon the erythrocyte's membrane, volume, surface area, and functional state.
Osteoblast	Cell involved in formation of calcified bone.
Osteoclast	Cell involved in resorption and remodeling of calcified bone.
Oxygen affinity	The ability for hemoglobin to bind and release oxygen. An increase in CO ₂ , acid, and heat decrease oxygen affinity, while an increase in pO ₂ increases oxygen affinity.
Oxyhemoglobin	The compound formed when hemoglobin combines with oxygen.
Pancytopenia	Marked decrease of all blood cells in the peripheral blood.
Panhypercellular	Increase in all blood cells in the peripheral blood.

Hematology

Pappenheimer bodies	Iron-containing particles in mature erythrocyte. On romanowsky stain, visible near the periphery of the cell and often occur in clusters.
Paroxysmal cold hemoglobinuria (PCH)	An autoimmune hemolytic anemia characterized by hemolysis and hematuria upon exposure to cold.
Paroxysmal nocturnal hemoglobinuria (PNH)	A stem cell disease in which the erythrocyte membrane is abnormal, making the cell more susceptible to hemolysis by complement. There is a lack of decay accelerating factor (DAF) and C8 binding protein (C8bp) on the membrane, which is normally responsible for preventing amplification of complement activation. The deficiency of DAF and C8bp is due to the lack of glycosyl phosphatidyl inositol (GPI), a membrane glycolipid that serves to attach (anchor) proteins to the cell membrane. Intravascular hemolysis is intermittent.
Pelger-Huët anomaly	An inherited benign condition characterized by the presence of functionally normal neutrophils with a bilobed or round nucleus. Cells with the bilobed appearance are called pince-nez cells.
Percent saturation	The portion of transferrin that is complexed with iron.
Pericardial cavity	Body cavity that contains the heart.
Pericardium	Membrane that lines the pericardial cavity.
Peripheral membrane protein	Protein that is attached to the cell membrane by ionic or hydrogen bonds but is outside the lipid framework of the membrane.

Hematology

Peritoneal cavity	Space between the inside abdominal wall and outside of the stomach, small and large intestines, liver, superior aspect of the bladder, and uterus.
Peritoneum	Lining of the peritoneal cavity.
Pernicious anemia	Megaloblastic anemia resulting from a lack of intrinsic factor. The intrinsic factor is needed to absorb cobalamin (vitamin B ₁₂) from the gut.
Petechiae	Small, pinhead-sized purple spots caused by blood escaping from capillaries into intact skin. These are associated with platelet and vascular disorders.
Phagocytosis	Cellular process of cells engulfing and destroying a foreign particle through active cell membrane invagination.
Phagolysosome	A digestive vacuole (secondary lysosome) formed by the fusion of lysosomes and a phagosome. The hydrolytic enzymes of the lysosome digest the phagocytosed material.
Phase microscopy	A type of light microscopy in which an annular diaphragm is placed below or in the substage condenser, and a phase shifting element is placed in the rear focal plane of the objective. This causes alterations in the phases of light rays and increases the contrast between the cell and its surroundings. This methodology is used to count platelets.
Phenotype	The physical manifestation of an individual's genotype, often referring to a particular genetic locus.
Phi body	A smaller version of the Auer rod.

Hematology

Pica	A perversion of appetite that leads to bizarre eating practices; a clinical finding in some individuals with iron deficiency anemia.
Pitting	Removal of abnormal inclusions from erythrocytes by the spleen.
PIVKA (protein-induced by vitamin-K absence or antagonist)	These factors are the nonfunctional forms of the prothrombin group coagulation factors. They are synthesized in the liver in the absence of vitamin K and lack the carboxyl (COOH) group necessary for binding the factor to a phospholipid surface.
Plasma cell	A transformed, fully differentiated B lymphocyte normally found in the bone marrow and medullary cords of lymph nodes. May be seen in the circulation in certain infections and disorders associated with increased serum γ -globulins. The cell is characterized by the presence of an eccentric nucleus containing condensed, deeply staining chromatin and deep basophilic cytoplasm. The large Golgi apparatus next to the nucleus does not stain, leaving an obvious clear paranuclear area. The cell has the PC-1 membrane antigen and cytoplasmic immunoglobulin.
Plasma cell neoplasm	A monoclonal neoplasm of immunoglobulin secreting cells.
Plasmacytosis	The presence of plasma cells in the peripheral blood or an excess of plasma cells in the bone marrow.

Hematology

Plasmin	A proteolytic enzyme with trypsin-like specificity that digests fibrin or fibrinogen as well as other coagulation factors. Plasmin is formed from plasminogen.
Plasminogen	A β -globulin, single-chain glycoprotein that circulates in the blood as a zymogen. Large amounts of plasminogen are absorbed with the fibrin mass during clot formation. Plasminogen is activated by intrinsic and extrinsic activators to form plasmin.
Plasminogen activator inhibitor-1 (PAI-1)	The primary inhibitor of tissue plasminogen activator (t-PA) and urokinase-like plasminogen activator (tzu-PA) released from platelet a granules during platelet activation.
Plasminogen activator inhibitor-2 (PAI-2)	An inhibitor of tissue plasminogen activator and urokinase-like plasminogen activator. Secretion of PAI-2 is stimulated by endotoxin and phorbol esters. Increased levels impair fibrinolysis and are associated with thrombosis.

Hematology

Platelet	<p>A round or oval structure in the peripheral blood formed from the cytoplasm of megakaryocytes in the bone marrow. Platelets play an important role in primary hemostasis adhering to the ruptured blood vessel wall and aggregating to form a platelet plug over the injured area. Platelets are also important in secondary hemostasis by providing platelet factor 3 (PF3) important for the activation of coagulation proteins. The normal reference range for platelets is 150—440 X 10⁹/L.</p>
Platelet activation	<p>Stimulation of a platelet that occurs when agonists bind to the platelet's surface and transmit signals to the cell's interior. Activated platelets form aggregates known as the primary platelet plug.</p>
Platelet adhesion	<p>Platelet attachment to collagen fibers.</p>
Platelet aggregation	<p>Platelet-to-platelet interaction that results in a clumped mass; may occur in vitro or in vivo.</p>
Platelet clump	<p>Aggregation of platelets; may occur when blood is collected by capillary puncture (due to platelet activation) and when blood is collected in EDTA anticoagulant (due to unmasking of platelet antigens that can react with antibodies in the serum).</p>
Platelet distribution width (PDW)	<p>Coefficient of variation of platelet volume distribution; analogous to RDW.</p>
Platelet factor 4	<p>Protein present in platelet's alpha granules that is capable of neutralizing heparin.</p>
Plateletpheresis	<p>A procedure in which platelets are removed from the circulation.</p>

Hematology

Platelet-poor plasma (PPP)	Citrated plasma containing less than $15 \times 10^9/L$ platelets. It is prepared by centrifugation of citrated whole blood at a minimum RCF of 1000 X g for 15 minutes. PPP is used for the majority of coagulation tests.
Platelet procoagulant activity	The property of platelets that enables activated coagulation factors and cofactors to adhere to the platelet surface during the formation of fibrin.
Platelet-rich plasma (PRP)	Citrated plasma containing approximately 200—300 $\times 10^9/L$ platelets. It is prepared by centrifugation of citrated whole blood at an RCF of 150 X g for 10 minutes. PRP is used in platelet aggregation studies.
Platelet satellitism	Adherence of platelets to neutrophil membranes in vitro; this can occur when blood is collected in EDTA anticoagulant.
Pleura	Lining of the pleural cavities.
Pleural cavity	Space between the chest wall and the lungs.
Plethora	Excess of blood.
Plumbism	Lead poisoning.
Pluripotential cell	Cell that differentiates into many different cell lines. Has the potential to self-renew, proliferate, and differentiate into erythrocytic, myelocytic, monocytic, lymphocytic, and megakaryocytic blood cell lineages.
Poikilocytosis	A term used to describe the presence of variations in the shape of erythrocytes.

Hematology

Polychromatophilia	The quality of being stainable with more than one stain; the term is commonly used to describe erythrocytes that stain with a grayish or bluish tinge with Romanowsky stains due to residual RNA, which takes up the blue portion of the dye.
Polychromatophilic erythrocyte	An erythrocyte with a bluish tinge when stained with Romanowsky stain; contains residual RNA. If stained with new methylene blue, these cells would show reticulum and would be identified as reticulocytes.
Polyclonal	Arising from different cell clones.
Polyclonal gammopathy	An alteration in immunoglobulin production that is characterized by an increase in immunoglobulins of more than one class.
Polycythemia	Condition associated with increased erythrocyte count.
Polymerase chain reaction	A procedure for copying a specific DNA sequence manyfold.
Polymorphic variants	Variant morphology of a portion of a chromosome that has no clinical consequence.
Polymorphonuclear neutrophil (PMN)	A mature granulocyte found in bone marrow and peripheral blood. The nucleus is segmented into 2 or more lobes. The cytoplasm stains pinkish and there is abundant specific granules. This is the most numerous leukocyte in the peripheral blood ($2\text{--}6.8 \times 10^9/\text{L}$). Its primary function is defense against foreign antigens. It is active in phagocytosis and killing of microorganisms. Also called a segmented neutrophil or seg.

Hematology

Porphyrins	A highly unsaturated tetrapyrrole ring bonded by four methane ($-\text{CH}=\text{}$) bridges. Substituents occupy each of the eight peripheral positions on the four pyrrole rings. The kind and order of these substituents determine the type of porphyrin. Porphyrins are only metabolically active when they are chelated.
Portland hemoglobin	An embryonic hemoglobin found in the yolk sac and detectable up to eight weeks gestation. It is composed of two zeta (ζ) and two gamma (γ) chains.
Postmitotic pool	Also called the maturation-storage pool; the neutrophils in the bone marrow that are not capable of mitosis. These cells include metamyelocytes, bands, and segmented neutrophils. Cells spend about 5–7 days in this compartment before being released to the peripheral blood.
Primary aggregation	The earliest association of platelets in an aggregate that is reversible.
Primary fibrinolysis	A clinical situation that occurs when there is a release of excessive quantities of plasminogen activators into the blood in the absence of fibrin clot formation. Excess plasmin degrades fibrinogen and the clotting factors, leading to a potentially dangerous hemorrhagic condition.
Primary hemostasis	The initial arrest of bleeding that occurs with blood vessel/platelet interaction.

Hematology

Primary hemostatic plug An aggregate of platelets that initially halts blood flow from an injured vessel.

Primary thrombocytosis An increase in platelets that is not secondary to another condition. Usually refers to the thrombocytosis that occurs in neoplastic disorders.

Probe A tool for identifying a particular nucleotide sequence of interest. A probe is composed of a nucleotide sequence that is complementary to the sequence of interest and is therefore capable of hybridizing to that sequence. Probes are labeled in a way that is detectable, such as by radioactivity.

Procoagulant An inert precursor of a natural substance that is necessary for blood clotting or a property of anything that favors formation of a blood clot.

Proficiency testing Utilizes unknown samples from an external source (e.g., College of American Pathologists) to monitor the quality of a given laboratory's test results.

Progenitor cell Parent or ancestor cells that differentiate into mature, functional cells.

Polymphocyte The immediate precursor cell of the lymphocyte; normally found in bone marrow. It is slightly smaller than the lymphoblast and has a lower nuclear to cytoplasmic ratio. The nuclear chromatin is somewhat clumped, and nucleoli are usually present. The cytoplasm stains light blue and is agranular.

Hematology

Promonocyte

A monocytic precursor cell found in the bone marrow. The cell is 14—18 μm in diameter with abundant blue-gray cytoplasm. Fine azurophilic granules may be present. The nucleus is often irregular and deeply indented. The chromatin is finely dispersed and stains a light purple-blue. Nucleoli may be present. Cytochemically, the cells stain positive for nonspecific esterase, peroxidase, acid phosphatase, and arylsulfatase. The cell matures to a monocyte.

Promyelocyte

A granulocytic precursor cell normally found in the bone marrow. The cell is 15—21 μm in diameter. The cytoplasm is basophilic and the nucleus is quite large. The nuclear chromatin is lacy, staining a light purple-blue. Several nucleoli are visible. The distinguishing feature is the presence of large blue-black primary (azurophilic) granules. The granules have a phospholipid membrane that stains with sudan black B. The granules contain acid phosphatase, myeloperoxidase, acid hydrolases, lysozyme, sulfated mucopolysaccharides, and other basic proteins. The promyelocyte matures to a myelocyte. Also called a progranulocyte.

Hematology

Pronormoblast	A precursor cell of the erythrocyte. The cell is derived from the pluripotential stem cell and is found in the bone marrow. The cell is 12—20 μm in diameter and has a high nuclear-cytoplasmic ratio. The cytoplasm is deeply basophilic with romanowsky stains. The nuclear chromatin is fine, and there is one or more nucleoli. Also called a rubriblast. The cell matures to a basophilic normoblast.
Prothrombinase complex	A complex formed by coagulation factors Xa and V, calcium, and phospholipid. This complex activates prothrombin to thrombin.
Prothrombin group	The group of coagulation factors that are vitamin K-dependent for synthesis of their functional forms and that require calcium for binding to a phospholipid surface. Includes factors II, VII, IX, and X. Also known as vitamin K-dependent factors.
Prothrombin time (PT)	A screening test used to detect deficiencies in the extrinsic or common pathway of the coagulation cascade and for monitoring the effectiveness of oral anticoagulant therapy.
Prothrombin time ratio	A calculation derived by dividing the patient's prothrombin time result by midpoint of the laboratory's normal range and used to calculate the International Normalized Ratio (INR).

Hematology

Pseudoneutrophilia	An increase in the concentration of neutrophils in the peripheral blood ($>6.8 \times 10^9/L$) occurring as a result of cells from the marginating pool entering the circulating pool. The response is immediate but transient. This redistribution of cells accompanies vigorous exercise, epinephrine administration, anesthesia, convulsion, and anxiety states; also called immediate or shift neutrophilia.
Pseudo—Pelger-Huët cells	An acquired condition in which neutrophils display a hyposegmented nucleus. Unlike the real Pelger-Huët anomaly, the nucleus of this cell contains a significant amount of euchromatin and stains more lightly. A critical differentiation point is that all neutrophils are equally affected in the genetic form of pelger-huët anomaly, but only a fraction of neutrophils will be hyposegmented cells in the acquired state. Associated with MDS and MPD; may also be found after treatment for leukemias.
Pulmonary embolism	Obstruction of the pulmonary artery or one of its branches by a clot or foreign material that has been dislodged from another area by the blood current.
Pure red cell aplasia (PRCA)	Anemia with selective decrease in erythrocyte precursors in the marrow.
Purging	A technique by which undesirable cells that are present in the blood or bone marrow products are removed.

Hematology

Purpura	(1) purple discoloration of the skin caused by petechiae and/or ecchymoses; (2) a diverse group of disorders that are characterized by the presence of petechiae and ecchymoses.
Pyknotic	Pertaining to degeneration of the nucleus of the cell in which the chromatin condenses to a solid, structureless mass and shrinks.
Quality control limit	Expected range of results. These limits are used to determine if a test method is in control, and to minimize the chance of inaccurate patient results. If the test method is out of control, an intervention is required to reconcile the problem.
Quiescence (G_0)	A phase in a cell that has exited the cell cycle and is in a nonproliferative state.
R (relaxed) structure	Conformational change in hemoglobin that occurs as the molecule takes up oxygen.
Radar chart	Graphical representation of eight CBC parameters: WBC, RBC, Hb, Hct, MCV, MCH, MCHC, and PLT. Lines are drawn to connect the parameters; resembles a radar oscilloscope. Changes in the shape of the radar chart are indicative of different hematologic disorders.
Random access	Capability of an automated hematology instrument to process specimens independently of one another; may be programmed to run individual tests (e.g., Hb or platelet counts) or a panel of tests (e.g., CBC with reticulocyte count) without operator intervention.

Hematology

Random variation	Variation within an instrument or test method that is due to chance. This type of variation can be either positive or negative in direction and affects precision.
RBC indices	The RBC indices help classify the erythrocytes as to their size and hemoglobin content. Hemoglobin, hematocrit, and erythrocyte are used to calculate the three indices: mean corpuscular volume (MCV), mean corpuscular hemoglobin concentration (MCHC), and mean corpuscular hemoglobin (MCH). The indices give a clue as to what the erythrocytes should look like on a stained blood film.
Reactive lymphocyte	An antigen stimulated lymphocyte that exhibits a variety of morphologic features. The cell is usually larger than the resting lymphocyte and has an irregular shape. The cytoplasm is more basophilic. The nucleus is often elongated and irregular with a finer chromatin pattern than that of the resting lymphocyte. Often this cell is increased in viral infections; also called a virocyte, or stimulated, transformed, atypical, activated, or leukocytoid lymphocyte.
Reactive neutrophilia	An increase in the concentration of peripheral blood neutrophils ($>6.8 \times 10^9/L$) as a result of reaction to a physiologic or pathologic process.
Reagent blank	Measurement of absorbance due to reagent alone; eliminates false increase in sample absorbance due to reagent color.
Red thrombus	Thrombus composed mostly of red blood cells; so named because of its red coloration.

Hematology

Reed-Sternberg cell	Cell found in the classic form of Hodgkin lymphoma. It is characterized by a multilobated nucleus and large inclusion-like nucleoli.
Reference interval	Test value range that is considered normal. Generally the range is determined to include 95% of the normal population.
Refractive Index	The degree to which a transparent object will deflect a light ray from a straight path.
Refractory	Pertains to disorders or diseases that do not respond readily to therapy.
Refractory anemia	A subgroup of the FAB classification of the myelodysplastic syndromes. Anemia refractory to all conventional therapy is the primary clinical finding. Blasts constitute <1% of nucleated peripheral blood cells. The bone marrow shows signs of dyserythropoiesis.
Refractory anemia with excess blasts (RAEB)	A subgroup of the FAB classification of the myelodysplastic syndromes. There are usually cytopenias and signs of dyspoiesis in the peripheral blood with <5% blasts. The bone marrow is usually hypercellular with dyspoiesis in all hematopoietic cell lineages. Bone marrow blasts vary from 5% to 20%.
Refractory anemia with excess blasts in transformation (RAEB-T)	A subgroup of the FAB classification of the myelodysplastic syndromes. There is/are cytopenia(s) in the peripheral blood with more than 5% blasts. The bone marrow is usually hypercellular with dyspoiesis and 20–30% blasts. In the WHO classification this would be considered acute leukemia (>20% blasts).

Hematology

Refractory anemia with ringed sideroblasts (RARS)	A subgroup of the FAB classification of the myelodysplastic syndromes characterized by <1% blasts in the peripheral blood, anemia, and/or thrombocytopenia and/or leukopenia. There are more than 15% ringed sideroblasts and <5% blasts in the bone marrow.
Remission	A diminution of the symptoms of a disease.
Replication	The process by which DNA is copied during cell division. Replication is carried out by the enzyme DNA polymerase, which recognizes single-stranded DNA and fills in the appropriate complementary nucleotides to produce double-stranded DNA. Synthesis is initiated at a free 5' end where double-stranded DNA lies adjacent to single-stranded DNA, and replication proceeds in the 5' direction. In the laboratory, DNA replication can be induced as a means of copying DNA sequences, as exploited in the polymerase chain reaction.
Reportable range	Range that is defined by a minimum value and a maximum value of calibration material.
Reticulocyte	First nonnucleated stage of erythrocyte development in the bone marrow. Contains RNA that is visualized as granules or filaments within the cell when stained supravivally with new methylene blue. Normally reticulocytes constitute approximately 1% of the circulating erythrocyte population.

Hematology

Reticulocyte production index (RPI) An indicator of the bone marrow response in anemia. The calculation corrects the reticulocyte count for the presence of marrow reticulocytes in the peripheral blood. Calculated as follows: (patient hematocrit [L/L] divided by 0.45 [L/L]) X reticulocyte count (%) X (1 divided by maturation time of shift reticulocytes) = RPI

Reticulocytosis The presence of excess reticulocytes in the peripheral blood.

Ribosomes A cellular particle composed of ribonucleic acid (RNA) and protein whose function is to synthesize polypeptide chains from amino acids. The sequence of amino acids in the chains is specified by the genetic code of messenger RNA. Ribosomes appear singly or in reversibly dissociable units and may be free in the cytoplasm or attached to endoplasmic reticulum. The cytoplasm of blood cells that contain a high concentration of ribosomes stains bluish purple with Romanowsky stains.

Richter's transformation Transformation from CLL to another disease, usually large B cell lymphoma.

Ringed sideroblasts Erythroblasts with abnormal deposition of excess iron within mitochondria resulting in a ring formation around the nucleus.

Romanowsky-type stain Any stain consisting of methylene blue and its oxidation products and eosin Y or eosin B.

Hematology

Rouleaux	Erythrocyte distribution characterized by stacking of erythrocytes like a roll of coins. This is due to abnormal coating of the cell's surface with increased plasma proteins, which decreases the zeta potential between cells.
Russell bodies	A globule filled with immunoglobulin found in pathologic plasma cells called Mott cells (see Mott cell).
Schistocyte	Fragment of an erythrocyte; a schistocyte may have a variety of shapes including triangle, helmet, and comma.
Secondary aggregation	Irreversible aggregation of platelets that occurs over time.
Secondary fibrinolysis	A clinical condition characterized by excessive fibrinolytic activity in response to disseminated intravascular clotting.
Secondary hemostasis	The formation of fibrin that stabilizes a primary platelet plug.
Secondary hemostatic plug	A primary platelet aggregate that has been stabilized by fibrin formation during secondary hemostasis.
Secondary thrombocytosis	An increase in platelet concentration in the blood. The increase is in response to stimulation by another condition.
Secretion	Energy dependent discharge or release of products usually from glands in the body but also pertaining to the contents of platelet granules that are released after stimulation of the platelets by agonists; also, the product that is discharged or released.
Self-renewal	The property of regenerating the same cells.

Hematology

Sensitivity	Refers to the ability of a test method to detect small quantities of the analyte.
Serine protease	The family of serine proteases includes thrombin, factors VIIa, IXa, Xa, XIa, XIIa, and the digestive enzymes chymotrypsin and trypsin. They selectively hydrolyze arginine- or lysine-containing peptide bonds of other zymogens converting them to serine proteases. Each serine protease involved in the coagulation cascade is highly specific for its substrate.
Shelf life	The time period for which a reagent or control is stable given appropriate storage conditions. Shelf life will change once the reagent or control is reconstituted if lyophilized or opened if liquid. See pseudoneutrophilia.
Shift neutrophilia	
Shift-to-the-left	The appearance of increased numbers of immature leukocytes in the peripheral blood.
Sickle cell (drepanocyte)	Elongated crescent shaped erythrocyte with pointed ends. Sickle cell formation may be observed in wet preparations or in stained blood smears from patients with sickle-cell anemia.
Sickle-cell anemia	A genetically determined disorder in which hemoglobin S is inherited in the homozygous state. No hemoglobin A is present. Hemoglobins S, F, A ₂ are present.
Sickle-cell trait	A genetically determined disorder in which hemoglobin S is inherited in the heterozygous state. The patient has one normal β -globin gene and one β^s -globin gene. Both hemoglobin A and hemoglobin S are present.

Hematology

Sideroacrestic	A defect in iron utilization.
Siderocyte	An erythrocyte that contains stainable iron granules.
Sideropenic	Lack of iron.
Small lymphocytic lymphoma (SLL)	Identical to CLL, but primarily involves the lymph nodes. The two disorders appear to belong to one disease entity with differing clinical manifestations.
Smudge cell	Cell whose cytoplasmic membrane has ruptured, leaving a bare nucleus. Increased numbers of smudge cells are observed in lymphoproliferative disorders like chronic lymphocytic leukemia. Can also be seen in reactive lymphocytosis and in other neoplasms.
Spherocyte	An abnormally round erythrocyte with dense hemoglobin content (increased MCHC). The cell has no central area of pallor as it has lost its biconcave shape.
Splenectomy	Removal of the spleen.
Splenomegaly	Abnormal enlargement of the spleen.
Spur cell anemia	An acquired hemolytic condition associated with severe hepatocellular disease such as cirrhosis, in which there is an increase in serum lipoproteins, leading to excess of erythrocyte membrane cholesterol. The total phospholipid content of the membrane, however, is normal.
Stab	See band.

Hematology

Stage	The stage of a neoplasm is the extent and distribution of disease. Determining the stage of disease usually involves radiologic studies, peripheral blood examination, and bone marrow aspiration and biopsy.
Starry sky	Morphologic appearance characteristic of high-grade lymphoma produced by numerous tingible body macrophages (stars) and a diffuse sheet of neoplastic cells (sky).
Stomatocyte	An abnormal erythrocyte shape characterized by a slit-like area of central pallor. This cell has a uniconcave, cup shape.
Streptokinase	A bacterial enzyme derived from group C-beta hemolytic streptococci that activates plasminogen to plasmin and is used as a thrombolytic agent in the treatment of thrombosis.
Stroma	Extracellular matrix or microenvironment that supports hematopoietic cell proliferation in the bone marrow.
Stromal cells	Cellular elements of the hematopoietic microenvironment in the red portion of bone marrow.
Submetacentric	Chromosome that has the centromere positioned off-center so that the short arm is shorter than the long arm.
Sucrose hemolysis test	A screening test to identify erythrocytes that are abnormally sensitive to complement lysis. In this test, erythrocytes, serum, and sucrose are incubated together. Cells abnormally sensitive to complement will lyse. The test is used to screen for paroxysmal nocturnal hemoglobinuria. Also called the sugar-water test.

Hematology

Sulfhemoglobin	Stable compound formed when a sulfur atom combines with each of the four heme groups of hemoglobin; it is incapable of carrying oxygen.
Supernatant	Clear liquid remaining on top of a solution after centrifugation of the particulate matter.
Supravital stain	A stain used to stain cells or tissues while they are still living.
Target cell	An abnormally shaped erythrocyte. The cell appears as a target with a bull's-eye center mass of hemoglobin surrounded by an achromic ring and an outer ring of hemoglobin. The osmotic fragility of this cell is decreased; also called mexican hat cell.
Tartrate resistant acid phosphatase (TRAP) T cell ALL	Acid phosphatase staining following tartrate incubation. An immunologic subgroup of ALL. There are two types of T-ALL: early T precursor ALL and T-ALL. T-ALL are differentiated using only two CD markers, CD7 (gp40 protein) and CD2 (E-receptor), and TdT.
Teardrop (dacryocytes)	Erythrocyte that is elongated at one end to form a teardrop or pear-shaped cell. Teardrop may form after erythrocytes with cellular inclusions have transversed the spleen. A teardrop cell cannot return to its original shape because it has either been stretched beyond the limits of deformability of the membrane or has been in the abnormal shape for too long a time.
Telangiectasia	Persistent dilation of superficially located veins.

Hematology

Thalassemia	A group of genetically determined microcytic, hypochromic anemias resulting from a decrease in synthesis of one or more globin chains in the hemoglobin molecule. The disorder may occur in the homozygous or heterozygous state. Heterozygotes may be asymptomatic but homozygotes typically have a severe, often fatal, disease. Thalassemia occurs most frequently in populations from the Mediterranean area and Southeast Asia.
Thrombocyte	See platelet.
Thrombocytopenia	A decrease in the number of platelets in the peripheral blood below the reference range for an individual laboratory (usually below $150 \times 10^9/L$).
Thrombocytosis	An increase in the number of platelets in the peripheral blood above the reference range for an individual laboratory (usually over $440 \times 10^9/L$).
Thromboembolism	Blockage of a small blood vessel by a blood clot that was formed in the heart, arteries, or veins, dislodged and moved through blood vessels until reaching a smaller vessel and blocking further blood flow.
Thrombogenic	Tendency to thrombose.
Thrombolytic therapy	Therapy designed to dissolve or break down a thrombus.

Hematology

Thrombomodulin	An intrinsic membrane glycoprotein present on endothelial cells that serves as a cofactor with thrombin to activate protein C. It forms a 1:1 complex with thrombin inhibiting thrombin's ability to cleave fibrinogen to fibrin but enhances thrombin's ability to activate protein C.
Thrombophilia	A tendency to form blood clots abnormally. Also referred to as hypercoagulability.
Thrombophlebitis	Thrombosis within a vein that is accompanied by an inflammatory response, pain and redness of the area.
Thrombopoietin	A humoral factor that regulates the maturation of megakaryocytes and the production of platelets.
Thrombosis	Formation of a blood clot or thrombus, usually considered to be under abnormal conditions within a blood vessel.
Thrombotic thrombocytopenia purpura (TTP)	Acute disorder of unknown etiology that affects young adults. Characterized by microangiopathic anemia, decreased number of platelets, and renal failure as well as neurological symptoms.
Thrombus	A blood clot within the vascular system.
TIBC	Total iron binding capacity; this refers to the total amount of iron that transferrin can carry, about 253—435 µg/dl.
Tingible body macrophage	Macrophages phagocytosing fragments of dying cells. They are found in areas of extensive apoptosis (reactive germinal centers and high-grade lymphoma).

Hematology

Tissue factor	A coagulation factor present on subvascular cells that forms a complex with factor VII when the vessel is ruptured. This complex activates factor X. Tissue factor is an integral protein of the cell membrane.
Tissue plasminogen activator (t-PA)	A serine protease that activates plasminogen to plasmin. It forms a bimolecular complex with fibrin increasing the catalytic efficiency of t-PA for plasminogen activation.
Toxic granules	Large, dark blue-black primary granules in the cytoplasm of neutrophils that are present in certain infectious states. Usually seen in conjunction with Döhle bodies.
Toxoplasmosis	A condition that results from infection with <i>Toxoplasma gondii</i> . Acquired infection may be asymptomatic, or symptoms may resemble infectious mononucleosis. There is a leukocytosis with relative lymphocytosis or rarely an absolute lymphocytosis and the presence of reactive lymphocytes.
Trabecula	Projection of calcified bone extending from cortical bone into the marrow space; provides support for marrow cells.
Transferrin	A plasma β_1 -globulin responsible for the binding of iron and its transport in the bloodstream. Each gram of transferrin can bind 1.25 mg of iron. The capacity of transferrin to bind iron is functionally measured as the total iron binding capacity (TIBC).

Hematology

Transglutaminase	Factor XIIIa is the only coagulation protein with transglutaminase activity. It catalyzes the formation of isopeptide bonds between glutamine and lysine residues on fibrin, forming stable covalent cross-links.
Transient erythroblastemia of childhood (TEC)	A temporary suppression of erythropoiesis that frequently occurs after a viral infection in infants and children. Therapy is supportive, and patients usually recover within two months.
Transplacental idiopathic thrombocytopenic purpura	A form of ITP that is present in newborns because of maternal transfer of platelet-destroying antibodies.
Transudate	Effusion that is formed due to increased hydrostatic pressure or decreased osmotic pressure; does not indicate a true pathologic state in the anatomic region.
Turnaround time	Time between specimen collection and reporting of a test result.
Type 1 VWD (classic VWD)	Quantitative decrease of structurally normal vWf.
Type 2 VWD	Qualitative disorder of vWf, four subtypes are possible: 2A, 2B, 2M, 2N.
Type 3 VWD	Severe, rare quantitative deficiency of vWf.
Type I myeloblasts	The classic description of myeloblasts. These cells contain no granules and have a highly immature nucleus.
Type II myeloblasts	More mature than the type I myeloblasts, these cells can contain Auer rods, phi bodies, and/or primary granules.

Hematology

UIBC (unsaturated iron binding capacity)	The portion of transferrin that is not complexed with iron. (TIBC — serum iron = UIBC).
Urokinase	An enzyme found in urine that activates plasminogen to plasmin and is used as a thrombolytic agent in the treatment of thrombosis.
Vasculitis	Inflammation of a blood vessel.
Vasoconstriction	Narrowing of the lumen of blood vessels that occurs immediately following an injury.
Viral load	Measuring the number of copies of HIV-1 RNA indicates a patient's viral load.
Viscosity	Resistance to flow; physical property is dependent on the friction of component molecules in a substance as they pass one another.
Vitamin K-dependent factors	See prothrombin group.
Vitronectin	Serum or extracellular-matrix glycoprotein capable of binding heparin.
Von Willebrand disease	An autosomal dominant hereditary bleeding disorder in which there is a lack of von Willebrand factor (vWf). This factor is needed for platelets to adhere to collagen. Platelet aggregation is abnormal with ristocetin. The bleeding time is also abnormal. The APTT may be prolonged due to a decrease in the factor VIII molecule secondary to a decrease in vWf.

Hematology

Von Willebrand factor (vWf)	A plasma factor needed for platelets to adhere to collagen. It binds to the platelet glycoprotein Ib. It is synthesized in megakaryocytes and endothelial cells. The vWf is a molecule of multimers. It is noncovalently linked to factor VIII in plasma.
Von Willebrand factor (vWf):Ag assay	A test that determines the amount of vWf.
Von Willebrand factor (vWf) multimer	A vWf molecule consisting of identical subunits.
Warm autoimmune hemolytic anemia	Anemia resulting from the presence of IgG autoantibodies that are reactive at 37°C with antigens on subject's erythrocytes. The antibody/antigen complex on the cell membrane sensitizes the erythrocyte, which is removed in the spleen or liver.
Wedge smear	Blood smear prepared on a glass microscope slide by placing a drop of blood at one end and with a second slide pulling the blood the length of the slide.
White thrombus	Thrombus composed mostly of platelets and fibrin that appears light gray.
Zymogen	An inactive precursor that can be converted to the active form by an enzyme, alkali, or acid. The inert coagulation factors are zymogens. Also called a proenzyme.

REFERENCES

1. Baker, FJ, Silverton RE. Introduction to Medical Laboratory Technology. 6th Edition. Butterworths and Co. 1985.
2. Cheesbrough M. District Laboratory Practice in Tropical Counties. Part 2. Cambridge University Press. 2000
3. Fischbach F. A Manual of Laboratory and Diagnostic Tests. 4th Edition J.B. Lippincott Co. 1992.
4. Hall, Roger and Malia, Robert G. Medical Laboratory Hematology. Butterworths and Co. 1984.
5. Hayhoe, F.G.J. and Flemans R.J. A Color Atlas of Hematological Cytology. 3rd Edition Wolfe Publishing Ltd. 1992.
6. Henry JB. Clinical Diagnosis and Management by Laboratory Methods. 20th Edition. W.B. Saunders Company. 2001.

Hematology

7. Hoffbrand, AV, Pettit JE. Essential Hematology. 3rd Edition. Blackwell Science. 1993.
8. Koepke, John A. Laboratory Hematology. Churchill Livingstone. 1984.
9. Lewis SM, Bain BJ, Bates I. Dacie and Lewis Practical Hematology. 9th Edition. Churchill Livingstone 2002.
10. Linne JJ, Ringsrud KM. Clinical Laboratory Sciences. The Basics and Routine Techniques. 4th edition. Mosby, Inc. 1999.
11. Luzzatto, Lucio (Editor). Clinics in Hematology: Hematology in Tropical Areas. Volume 10 Number 3 W.B. Saunders Co. Ltd. 1981.
12. Raphael, Stanley S. Lynch's Medical Laboratory Technology. 4th Edition Igaku-Shoin/Saunders International Edition. 1983.

Hematology

13. Ringsrud KM, Linne JJ. Urinalysis and Body Fluids. Mosby, Inc. 1995.
14. Robinson, SH, Reich PR. Hematology: Pathophysiologic Basis For Clinical Practice. 3rd Edition. Little, Brown and Company. 1993.
15. WHO Manual of Basic Techniques for a Health Laboratory. 1981
16. Wintrobe, Maxwell M. Clinical Hematology. 8th Edition. Lea and Febiger Philadelphia 1981.