

LECTURE NOTES

For Health Science Students

<https://ismailpages.wordpress.com/>
<https://ismailwabdi.wordpress.com/health/>

Physiology Part I



Yekoye Abebe, Bhardwaj, G.P.,

Habtamu Mekonnen

University of Gondar
Jimma University

In collaboration with the Ethiopia Public Health Training Initiative, The Carter Center,
the Ethiopia Ministry of Health, and the Ethiopia Ministry of Education

2006



Funded under USAID Cooperative Agreement No. 663-A-00-00-0358-00.

Produced in collaboration with the Ethiopia Public Health Training Initiative, The Carter Center, the Ethiopia Ministry of Health, and the Ethiopia Ministry of Education.

Important Guidelines for Printing and Photocopying

Limited permission is granted free of charge to print or photocopy all pages of this publication for educational, not-for-profit use by health care workers, students or faculty. All copies must retain all author credits and copyright notices included in the original document. Under no circumstances is it permissible to sell or distribute on a commercial basis, or to claim authorship of, copies of material reproduced from this publication.

©2006 by Yekoye Abebe, Bhardwaj, G.P., Habtamu Mekonnen

All rights reserved. Except as expressly provided above, no part of this publication may be reproduced or transmitted in any form or by any means, electronic or mechanical, including photocopying, recording, or by any information storage and retrieval system, without written permission of the author or authors.

This material is intended for educational use only by practicing health care workers or students and faculty in a health care field.

PREFACE

We have prepared lecture note that fits the academic curriculum designed for the students of Health Sciences in Ethiopia. This lecture note has two parts.

Part one includes the following five chapters: Principles of physiology, Excitable tissues (nerve and muscle), physiology of blood, Cardiovascular physiology and Respiratory physiology;

Part two contains the following seven chapters: physiology of the renal system, physiology of the gastrointestinal system, physiology of the endocrine system, physiology of the reproductive system, Neurophysiology, physiology of the Special senses and the Autonomic nervous system.

ACKNOWLEDGEMENTS

We are grateful to some students and teachers who have commented favorably on the clarity of the writing, and the emphasis on the core aspects of physiology. We express sincere appreciation to the secretaries for meticulous computer type settings of the teaching material.

SEPTEMBER, 2004
GONDAR , ETHIOPIA

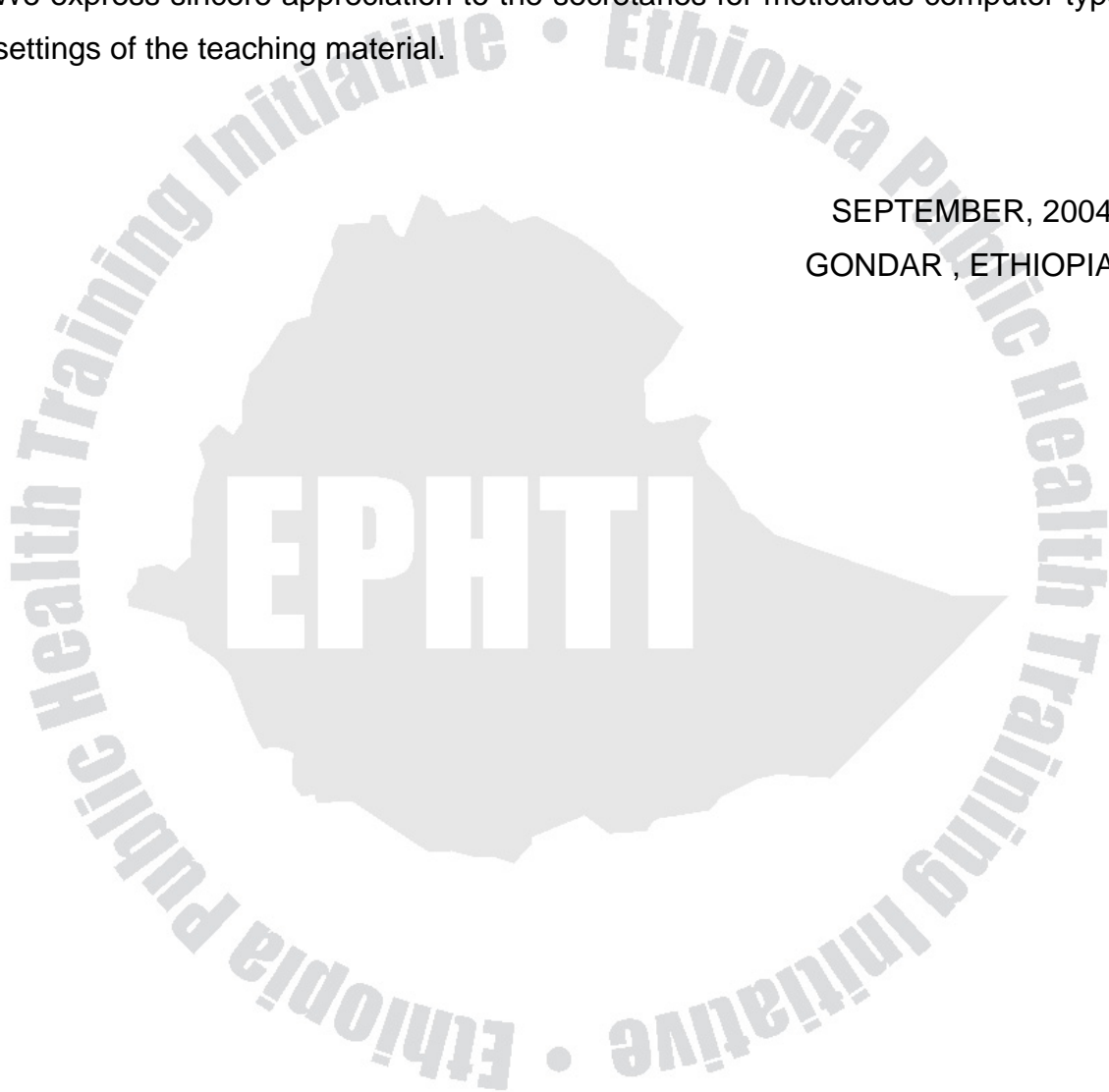

TABLE OF CONTENTS

Preface	i
Acknowledgement	ii
Table of contents	iii
List of tables	v
CHAPTER ONE: GENERAL PRINCIPLES OF HUMAN PHYSIOLOGY ..	1
Introduction	2
Composition of the body	4
Homeostasis	6
Cellular Physiology	10
Organelles	13
Membrane transport	26
Intercellular communication and signal transduction	33
Homeostatic Control	41
Feedback mechanisms	43
Cellular adaptation	53
CHAPTER TWO: EXCITABLE TISSUE: NERVE AND MUSCLE	60
Membrane potential	60
Neurons	63
The action potential	68
Neuromuscular junction/synapse	75
Physiology of the neuromuscular junction	76
Mechanism of action of acetylcholine	76
Chemical neurotransmitter	79
Skeletal muscle	80
Excitation-Contraction Coupling	84
Smooth and cardiac muscle	92
CHAPTER THREE: CARDIOVASCULAR SYSTEM	99
The blood	99

Erythrocytes	104
Hemoglobin molecule: structure and function	106
Blood Groups & Blood Transfusion	113
Leukocytes	118
Neutrophils	124
Lymphocytes	126
The body defenses	129
Hemostasis	132
Disorders of hemostasis	138
The Heart.....	141
Innervations of the heart	146
Electrocardiogram	152
Venous system	167
Cardiac output	171
Microcirculation	184
Measurement of arterial pressure	188
Regulation of flow through blood vessels	193
Circulatory shock	209
Hypertension	213
Glossary	221
CHAPTER FOUR: THE RESPIRATORY SYSTEM	229
Function of the respiratory system	230
Functional anatomy of the respiratory system	230
Pulmonary blood flow	232
Lung volumes and capacities	232
Mechanics of breathing	236
Diffusion of gases	241
Gas transport in tissues	245
Control of breathing	258
Hypoxia	264
Disorders of the respiratory system	268

LIST OF TABLES

Table 1. Elements in the human body	5
Table 2. Components of body system	6
Table 3. Concentration and permeability of ions responsible for membrane potential in a resting nerve cell	61
Table 4. Concentration and electrical gradients	61
Table 5. Fiber diameter and speed of signal conduction	66
Table 6. Blood constituents and their function	101
Table 7. Elements of the Blood	102
Table 8. Plasma components and other characters	103
Table 9. Important carrier proteins of plasma	104
Table 10. The major normal variants of hemoglobin	107
Table 11. Summary of ABO system	113
Table 12. ABO Blood groups: genotype and phenotype	115
Table 13. Choosing ABO-compatible red cells for transfusion	115
Table 14. The major hematopoietic growth factors for transfusion	121
Table 15. Normal values for leukocytes	124
Table 16. Some humoral mediators produced by T-lymphocytes	127
Table 17. Function of lymphoid tissues	131
Table 18. The major types of shock	211

CHAPTER ONE

GENERAL PRINCIPLES OF HUMAN PHYSIOLOGY

LEARNING OBJECTIVES:

After completing this chapter, the student is expected to know the following.

- Know that cells as the basic units of life.
- Understand that homeostasis is essential for cell survival, disruption in homeostasis can lead to illness and death, homeostatic control systems include closed and open loop systems
- Know the negative and positive feedback mechanisms
- Know the 3 levels of physiological regulations: intracellular, local (intrinsic) and extrinsic
- Know the neural and endocrine reflexes control many events such as: somatic, autonomic, endocrine reflexes
- Know most cells are subdivided into plasma membrane, nucleus and cytoplasm.
- Know the functions of the ER, Golgi complex, lysosomes, peroxisomes, mitochondria, cytosol, cytoskeleton, plasma membrane is a fluid bilayer embedded with proteins, membrane proteins, the extra cellular matrix
- Know the mechanisms of osmosis of water and diffusion of lipid soluble substances and small ions through the plasma membrane down their electrochemical gradients
- Special mechanisms used to transport selected molecules unable to cross the plasma membrane on their own: carrier mediated; endocytosis; exocytosis.
- Communications between cells is largely by extra cellular chemical messengers: paracrines, neurotransmitters and neurohormones.
- Activation of second messengers system by extra cellular (first) messengers: cAMP, cGMP, inositol triphosphate, Ca^{++} , diacylglycerol.

INTRODUCTION

Physiology tells us how the bodies of living organisms work. Physiology is based on the gross and microstructure. Both structure and function must be studied at all levels from the cellular to the molecular to the intact organism.

All aspects of human physiology evolved in the thousands of inherited units of DNA called genes. This genetic imprint is passed from parents to children. We all inherit a mixture of genes present in parents. There is immense genetic diversity, as a result of small spontaneous change in individual genes, called mutation, occurring from time to time. The natural selection concept of Charles Darwin emphasizes the predominance of the genes in the population that favors survival of the fittest and reproduction in a particular environment.

Early with life on earth cells developed the ability to react with oxygen and carbon compounds and use the energy released by these chemical reactions. With complexity of development cells evolved structure called mitochondria for efficient energy production. The efficiency of oxidative phosphorylation was maximized in natural selection of the best. The mitochondria of cells in mammals are same in appearance and function. Some aspects of human physiology may be rapidly changing on the evolutionary scale of time. Homosapiens have walked on the earth for perhaps 1.5 million years, but human brain has reached its present size only about 35,000 years back. The brain capabilities are probably still rapidly evolving as new pressures are faced. For pain with injury, a warning signal results in sudden withdrawal of the injured part, protecting it from further injury. But step-by-step sequence of events starts with the injury and eventually ends with the contraction of group of muscles that flex the injured limb - stimulus, receptor, electric signals, spinal cord, flexor muscles. There are links between the nerve and the spinal cord, and the muscle. The circuit that creates this response is genetically determined and is formed during early development of the nervous system.

Levels of structural organization: From single cell to organ system cells are the basic units of living organisms. The number of cells is very large. For example, an adult

person contains approximately 100 trillion cells. Humans have several levels of structural organizations that are associated with each other. The chemical level includes all chemicals substances essential for sustaining life. These chemicals are made up of atoms joined together in various ways. The diverse chemicals, in turn, are put together to form the next higher level of organization, the cellular level. Cells are the basic structural and functional units of life and organization. Each cell has a different structure and each performs a different function.

Muscle tissue is specialized for contraction and generation of tension. The different types of muscle tissue are functional adaptation of the basic contractile system of actin and myosin. Skeletal muscles are responsible for movement of the skeleton, cardiac muscle for the contraction of the heart that causes blood circulation; smooth muscle is responsible for propelling contents within soft hollow organs, such as the stomach, intestine, and blood vessels. Smooth muscle is not under voluntary control and has no striations. Cardiac muscle fibers branch but are separated into individual cell by continuity of the plasma membrane, the intercalated discs.

Nervous System- Conducting signals

This tissue is specialized for conduction and transmission of electrical impulses and the organization of these nerve cells or neurons is the most complex of any of the tissue. The neuron has a cell body that contains the nucleus and the other organelles with very high metabolic activity (e.g., ribosomes and mitochondria). The neuron is further specialized for having processes, which contact it through the synapses to other neurons, making a long chain of conducting tissue linking the various parts of the body.

Epithelial tissue:

It is functionally very diverse. It includes the membranes that cover body surfaces and line hollow viscera internal organs, forming barrier between the interior of the body and the environments. Epithelial cells may be modified to function as sensory receptor, detecting specific stimuli from the environment. Epithelial cells also form the endocrine glands (pituitary, parathyroids, thyroid, adrenals, ovary, and testis), which secrete

hormones directly into the blood and the exocrine glands secrete substances via ducts (e.g., salivary glands, pancreas and liver).

Connective Tissue

It is mesodermal in origin and functions in supporting, connecting and transporting. It covers wide variety of tissues, but having more intercellular materials or matrix, than cells. It also contains extracellular fibers, which may be tough collagenous fibers or the resilient elastic fibers.

Life processes: The following are the important life processes of humans:

Metabolism: includes catabolism and anabolism that provides energy and body's structural and functional components

Excitability: Ability to sense changes in and around us.

Conductivity: ability to carry the effects of stimulus from part of a cell to another.

Contractility: ability to contract in response to stimulus

Growth

Differentiation

Reproduction

COMPOSITION OF THE BODY

At an average, 60% of the body weight of young adult male is water. The remaining is composed of minerals, fat and proteins. The human body contains organic compounds such as lipids, proteins, carbohydrates and nucleic acids. The lipids are important forms of storage fuel in addition to providing insulation of the body as a whole or essential component in the structure of plasma membranes, myelin and other membranes. Carbohydrates serve as a lesser form of fuel storage (400-500 gms). Proteins serve as the structural basis for all enzymes, contractile muscle proteins, connective tissue, such as collagen and elastin and in addition as a fuel (about 15%), or precursor for carbohydrate in the process of gluconeogenesis. Ingested glucose is converted to glycogen and stored in the liver, muscle and adipose tissue.

Table 1. Elements in the Human Body

Element	Body weight %
Hydrogen, H	9.5
Carbon, C	18.5
Nitrogen, N	3.3
Oxygen, O	65.0
Sodium, Na	0.2
Magnesium, Mg	0.1
Phosphorus, P	1.0
Sulfur, S	0.3
Chlorine, Cl	0.2
Potassium	0.4
Calcium	1.5

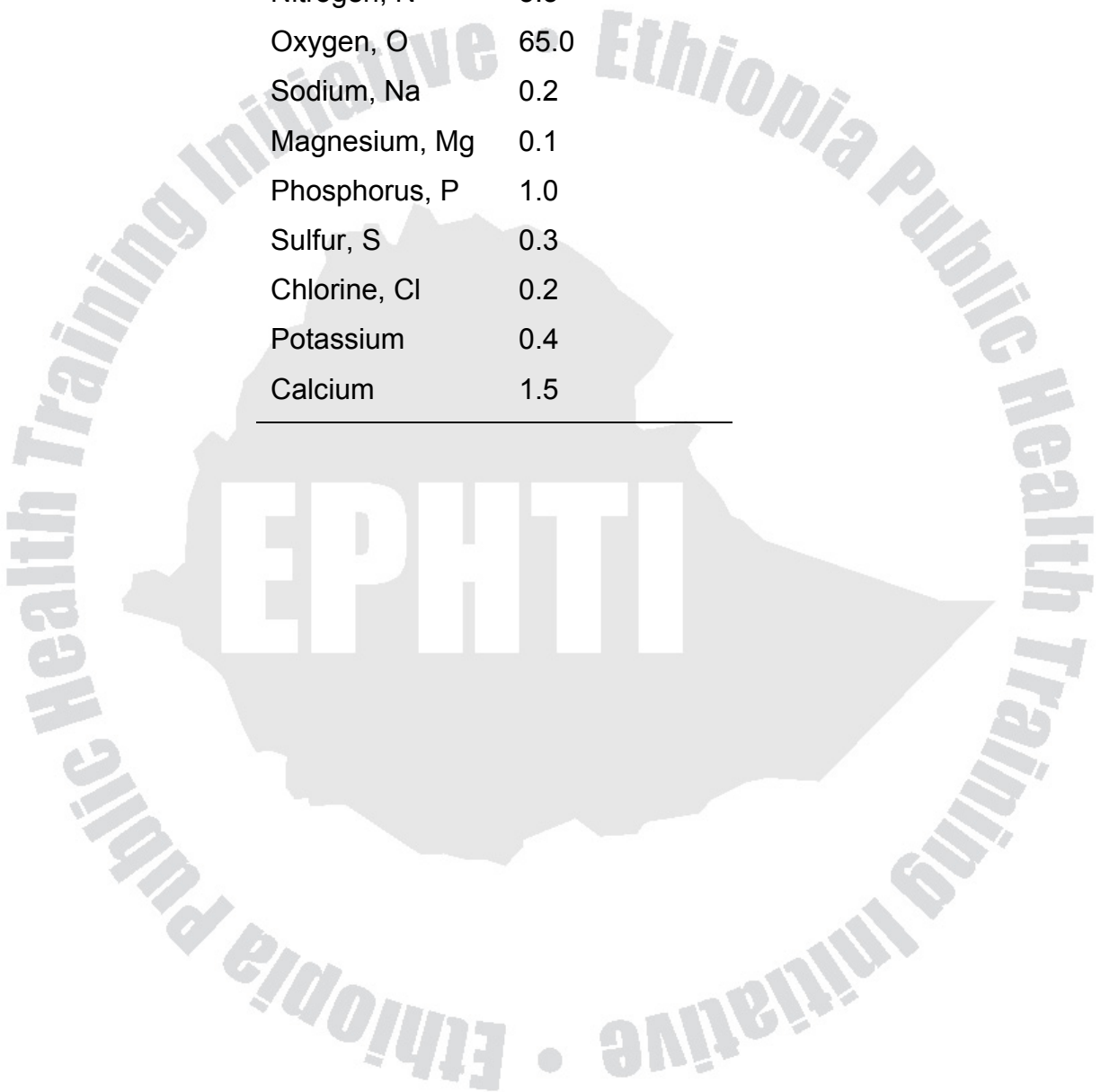

Table 2. Components of Body System

System	Components
Circulation	Heart, blood vessels, blood
Digestive system	Mouth, pharynx, esophagus, stomach, small & large intestine, salivary glands, pancreas liver, and gallbladder
Respiratory system	Nose, pharynx, larynx, trachea, bronchi, lungs
Urinary system	Kidneys, ureters, urinary bladder, urethra
Skeletal system	Bones, cartilage, joints
Muscle system	Skeletal muscle
Integumentary system	Skin, hair, nails
Immune system	Leukocytes, thymus, bone marrow, tonsils, adenoids, lymph nodes, spleen, appendix, gut-associated lymphoid tissue, skin-associated lymphoid tissue muscosa associated lymphoid tissue
Nervous system	Brain, spinal cord, peripheral nervous system. Special sense organs
Endocrine system	All hormone-secreting tissues including hypothalamus, pituitary, thyroid, parathyroids, adrenals, endocrine pancreas, kidney, intestine, heart, thymus, pineal
Reproductive system	Male: testis, prostate, seminal vesicles, bulbourethral glands, associated ducts Female: ovary, oviduct, uterus, vagina, breast.

HOMEOSTASIS

Homeostasis is a delicately balanced state. Large part of physiology is concerned with regulation mechanisms that act to maintain the constancy of the internal environment. Many of these regulatory mechanisms operate on the negative feedback. Homeostasis is the dynamic steady state of the internal environment. Departures from the steady state are opposed by negative feedback regulation. The structure and chemical

reactions of living organisms are sensitive to the chemical and physical conditions within and around cells. Cells must be wet and surrounding fluid must be fresh or salty seawater. For multicellular organisms, the surrounding fluid is the interstitial fluid: a component of the extracellular fluid.

The intracellular fluid has a high concentration of potassium and low concentration of Na^+ , Cl^- , Mg^{++} , and Ca^+ . In addition, cells need a ready supply of nutrients, that serve as structural building molecules, and source of energy as ATP (chemical energy). Body temperature is very crucial for intracellular physiological processes; enzymatic events need a very narrow range of temperature, within the physiological range of temperature compatible with life, cooler temperature favors preservations of cellular structure but slows the rate of chemical reactions carried out by cells. The higher temperature enhances chemical reactions, but may also disrupt the structure of the proteins and other macromolecules within cells. The production of energy for cellular activities requires oxygen and nutrients reaching the cell interior and carbon dioxide and other chemical wastes products be transferred to the environment. Extensive exchange between cells and immediate surroundings, interstitial fluid, occurs by diffusion based on a concentration gradient. Diffusion causes adequate movement of dissolved nutrients, gases and metabolic end products to meet the active needs of the cell, if the distance is short. If the distance increases, the time for diffusion increases too. For the efficiency of diffusion, the diameter of individual cells is usually not more than a few tenths of a millimeter. With the evolution of multicellular organisms, body plans include an internal fluid environment for the cells, called extracellular fluid (ECF). The ECF includes both the interstitial fluid and the plasma. In the circulatory system, blood rapidly moves between the respiratory system, where gases are exchanged; the kidney where wastes and excess of fluid and solutes are excreted; and the digestive system where nutrients are absorbed. These substances are rapidly transported by blood flow overcoming the diffusion limit on large body size.

By maintaining a relatively constant internal environment, multicellular organisms are able to live freely in changing external environment. Cannon called it 'homeostasis'

(Greek, homeo = same; stasis = staying). Homeostasis of the internal environment involves control of the chemical composition and volume of ECF; blood pressure and body temperature, etc. Most control systems use negative feedback (NFB). In NFB the control system compares a controlled variable with a set point value. Responses tend to oppose the change and restore the variable to its set point value. All organ systems have regulatory processes for maintaining a delicate balance in a dynamic steady state. If external environment stresses are very severe beyond the homeostatic processes, the balance can be overwhelmed. Prolonged exposure to cold may lead to an intolerable reduction in the body temperature. Exercise in very hot environment, may result in fluid depletion and an increase in the core temperature, resulting in heat stroke. The cells are much adapted to a regulated core temperature that even a few degree of temperature variations may have fatal consequences. Without clothes and proper protection humans can tolerate only a narrow differences between body temperature and environmental temperature.

Many diseases impair homeostasis. Factors homeostatically maintained include:

- Concentration of nutrient molecules
- Concentration of oxygen and carbondioxide
- Concentration of waste products
- pH
- Temperature
- Concentration of water, salt, and other electrolytes
- Volume (fluids), osmolality, and pressure

Homeostasis is essential for survival of cells in that :

- Cells need homeostasis for their own survival and for performing specialized function essential to survival of the whole body.
- Cells need a constant supply of nutrient and oxygen and ongoing elimination of acid-forming carbon dioxide, to generate energy needed to power life sustaining cellular activities as follows:

Food + Oxygen = Carbondioxide + water + Energy

ROLE OF BODY SYSTEM IN MAINTAINING HOMEOSTASIS

Body systems are made up of cells organized according to specialization to maintain homeostasis.

Nervous System:

Information from the external environment relayed through the nervous system.

Nervous system acts through electrical signals to control rapid responses for higher functions e.g., concentration, memory, and creativity

Endocrine System:

Acts by means of hormones secreted into the blood to control processes that require duration rather than speed, e.g., metabolic activity and water and electrolyte balances

Circulatory system:

Transports nutrients, oxygen, carbon dioxide, wastes, electrolytes, and hormones throughout the body

Respiratory system:

Obtains oxygen from and eliminates carbon dioxide to the external environment; helps regulate pH by adjusting the rate of removal of acid-forming carbon dioxide

Urinary system:

Important in regulating the volume, electrolyte composition, and pH of the internal environment; removes waste and excess water, salt, acid, and other electrolytes from the plasma and eliminates them into the urine.

Digestive system:

Obtains nutrients, water and electrolytes from the external environment and transfers them into the plasma; eliminates undigested food residues to the external environment

Muscular and Skeletal system:

Supports and protects body parts and allows body movements; heat generated by muscular contraction are important in temperature regulation; calcium is stored in the bones

Immune system:

Defense against foreign invaders and cancer cells; paves way for tissue repair

Integumentary system:

keeps internal fluids in and foreign materials out serves as a protective barrier between the external environment and the remainder of the body; the sweat glands and adjustment in blood flow are important in temperature regulation

Cellular physiology

Cells are the link between molecules and human. They have many molecules in a very complex organization and have the feature of interaction and represent a living entity. Cells are the living building blocks for the immense multicellular complicated whole body. Cells making the body are too small to be seen by the unaided eyes. About 100 average-sized cells placed side by side would be only about 1mm. Many cells share some common features despite diverse structure and functional specialization. Most cells have 3 subdivisions: the plasma membrane, the nucleus, and the cytoplasm.

Plasma membrane/cell membrane: It is very thin membrane structure that enclose each cell, separating the cell's contents from the surrounding. The fluid contained inside the cell is ICF, and the fluid outside the cell is extracellular fluid (ECF). The plasma membrane holds the cell contents, but has the ability in selectively controlling movement of molecules between the ECF and intracellular fluid (ICF).

The nucleus: This is distinctly oval or spherical shaped central structure surrounded by a double-layered membrane. Within the nucleus is DNA which directs protein synthesis and serves as a genetic blueprint during cell replication. DNA gives codes, or "instruction" for directing synthesis of specific structure and enzymes proteins within the cell. By monitoring these protein synthesis activity, the nucleus indirectly governs most cellular activities and serves as the cell's master. Three types of RNA are involved in protein synthesis. First, DNA's genetic code for a particular protein synthesis. First, DNA's genetic code for a particular protein is transcribed into a messenger-RNA, which leaves nucleus through the nuclear pores of the nuclear membrane. Within the cytoplasm, m-RNA delivers the coded message to the ribosomal RNA, which "reads" message/code and translates it into the appropriate amino acids sequence for the designated protein being synthesized. Finally, transfer-RNA transfers the appropriate amino acids within the cytoplasm to their designated site in the protein under

production. During cell replication, DNA ensures that the cell produces additional cells just like itself thus continuing the identical types of cell line within the body. Furthermore, in the sperm and ova, the DNA blueprint serves to pass the genetic characteristics to future generation- from parents to offsprings.

The Cytoplasm: The cytosol is the material of cell interior not occupied by the nucleus, containing a number of distinct, highly organized membrane-enclosed structures- the organelles- dispersed within a complex jelly – like marrow called the ‘cytosol’. All cells contain six main types of organelles- the endoplasmic reticulum, Golgi complex, lysosomes, peroxisomes, mitochondria, and vacules. They are similar in all cells, but with some variations depending on the cell specialization. Each organelle is a separate compartment, containing different chemically setting for fulfilling a partial or cellular function. These organelles occupy about half of the total cell volume. The remaining part of the cytoplasm is cytosol (see fig. 1)



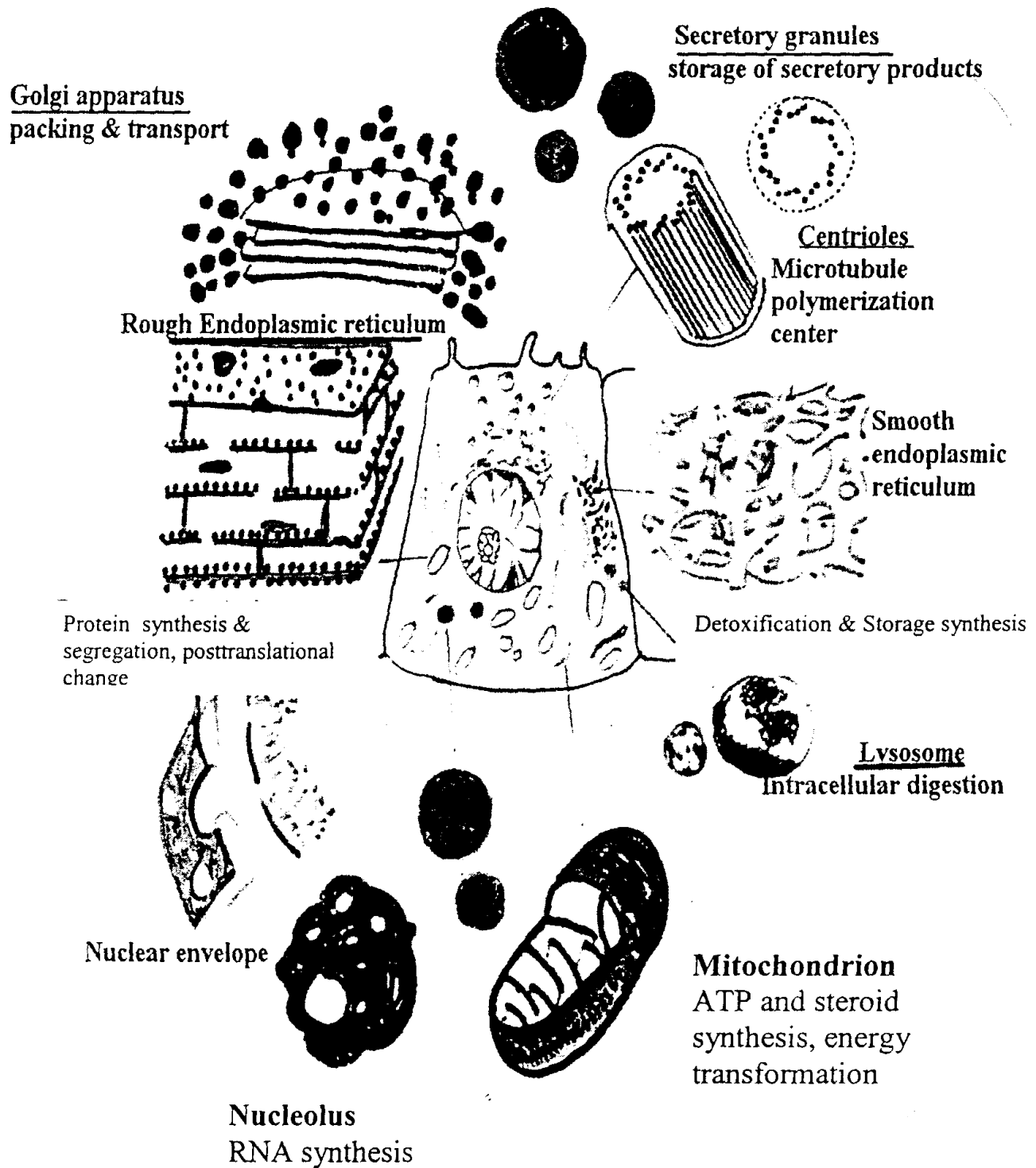

Figure1. The compositions of a typical cell are in the center and the detailed structure of organelles is shown around the outside.

ORGANELLES

Endoplasmic Reticulum (ER)

The endoplasmic reticulum is a fluid-filled membrane system extensively present throughout the cytosol. The two different types are smooth endoplasmic reticulum and the rough ER (See figure 2). The smooth ER is a meshwork of interconnected tubules, whereas the rough ER projects outwards from the reticulum as stacks of flattened sacs. Though different in structure and function, they are continuous with each other. The ER is one continuous organelle with many communicating channels.

The rough Endoplasmic Reticulum:

The outer surface of the rough ER contains dark particles called ribosomes, which are ribosomal RNA protein complexes that produce protein under the direction of nuclear DNA. Messenger-RNA carries the genetic message from the nucleus to the ribosomes “workshop” where proteins are synthesized. Some ribosomes are “free” dispersed throughout the cytosol. The rough ER in association with ribosomes produces and releases a variety of proteins, into the fluid-filled space enclosed by the membrane. Some proteins for export as secretory products (hormones or enzymes). Other proteins are transported to sites within the cell for use in the construction of new plasma membrane or new organelle membrane.

Cellular membrane contains predominantly fats and proteins. ER membrane also contains enzymes required for the synthesis of almost all the lipids needed for the production of new membranes. These lipids enter the ER lumen along with the proteins. This structure is well developed in cells producing digestive enzymes or in rapidly growing cells.

Each ribosome is involved in producing only one type of protein. The free ribosomes synthesize enzyme protein that are used intracellularly within the cytosol.

Smooth Endoplasmic Reticulum:

It does not have ribosomes hence looks 'smooth'. It serves a variety of other functions that differ in cell types; it does not produce proteins. In most cells, the smooth ER is sparse and serves packaging and discharge site for protein molecules that are to be transported from the ER. All new proteins and fats pass from ER to gather in the smooth ER. Portions of the smooth ER then "bud off/pinch off", giving rise to 'transport vesicles', they contain the new molecule wrapped in a membrane derived from the smooth ER membrane. Transport vesicles move to the Golgi complex for further processing of their cargo. Some specialized cells have an extensive smooth ER, which has additional functions as follows:

- The smooth ER is well developed in cells specialized in lipid metabolism- cells that synthesize steroid hormones. The membrane wall of the smooth ER contains enzymes for synthesis of lipids. This is an additional site for synthesis in addition for ER to keep pace with demands for hormone secretion.
- In liver cells, the smooth ER contains enzymes involved in detoxifying harmful endogenous substances produced within the body by metabolism or exogenous substances entering the body from outside as drugs or other foreign compounds. The detoxifying enzymes alter toxic substances so that they could be easily eliminated in the urine. But unfortunately, in some instances the same enzyme transforms otherwise harmless substance into carcinogens that play a role in cancer development.
- The smooth ER has a special role in skeletal muscle cells. They have an elaborate network of smooth ER, which stores ionic calcium and plays a crucial role in the process of muscle contraction

The Golgi Complex

- The Golgi complex is a refining plant and directs molecular traffic.
- The Golgi complex is elaborately associated with the ER and contains sets of flattened, curved, membrane- enclosed sacs, or cisternae, stacked in layers.

Number of stacks vary in cells; cells specialized for protein secretion have hundreds of stacks, whereas some have only one

The majority of newly formed molecules budding off from the smooth ER enter a Golgi complex stacks. It performs the following important functions.

1. Processing the raw material into finished products. In the Golgi complex, the “raw” protein from the ER are modified into their final state mainly by adjustment made in the sugar attached to the protein. This is a very elaborate, precisely programmed activity, specific for each final product.
2. Sorting and directing finished product to their final destination. According to their function and destination, different types of products are segregated by the Golgi complex, i.e., molecules that are destined for secretion to the exterior, molecules that will eventually become part of the plasma membrane, and the molecules that will become incorporated into other organelles.
3. The smooth ER of the liver and kidney cells are responsible for the detoxification and inactivation of drugs. Enzymes within the smooth ER can inactivate or destroy a variety of chemicals including alcohol, pesticides, and carcinogens.
4. In skeletal muscle cells, a modified form of smooth ER stores Ca^{++} to be released for muscle contraction.

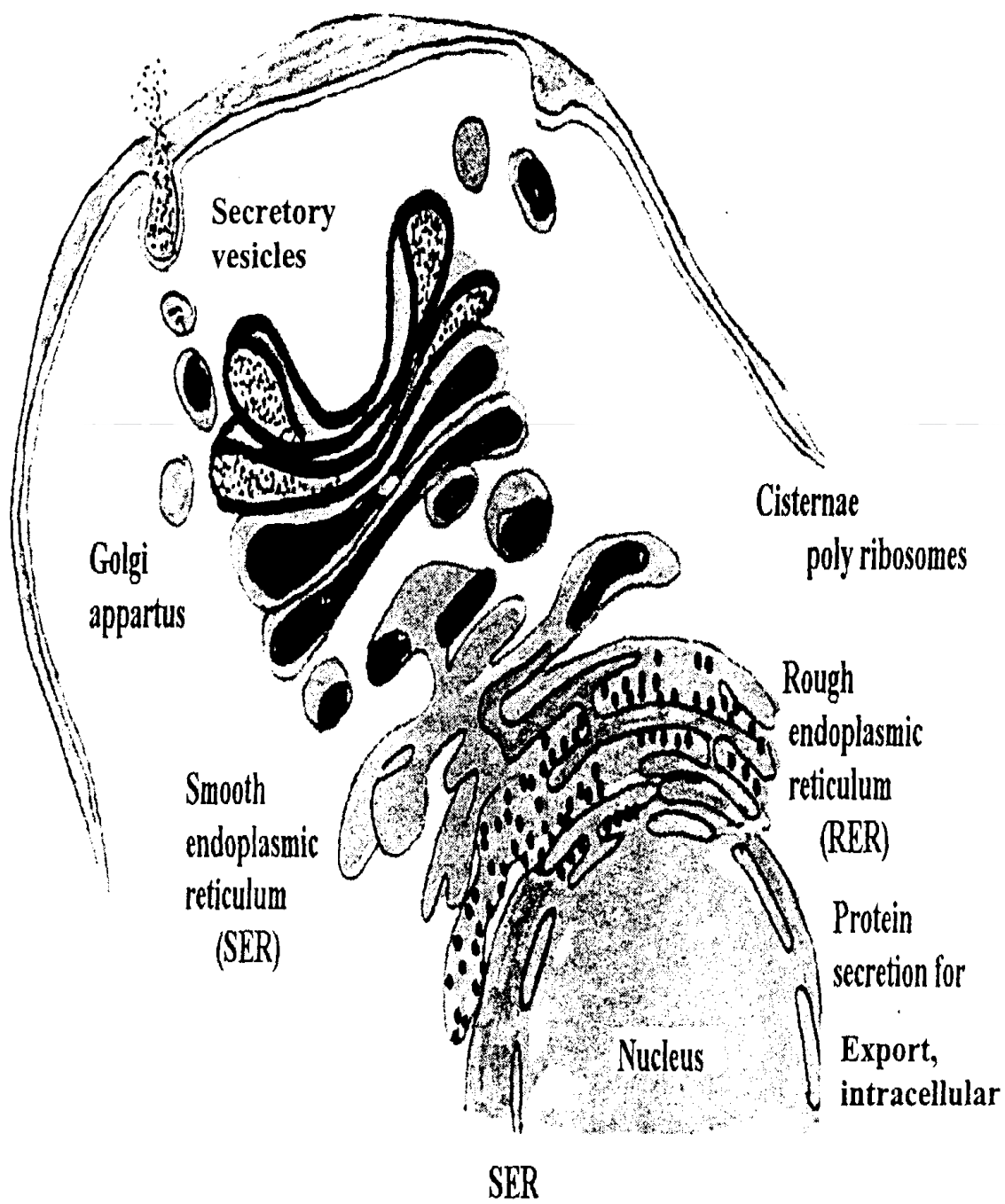

SER

Figure 2. Structure of endoplasmic reticulum and its relation with the Golgi apparatus and the nucleus.

Lysosomes

Lysosomes serve as the intracellular “digestive system”.

Lysosomes are membrane-enclosed sacs containing powerful hydrolytic enzymes capable of digesting and removing unwanted cellular debris and foreign materials such as bacteria that have been internalized within the cell.

Lysosomes vary in size and shape, and about 300µm in a cell. Surrounding membrane confines these enzymes, preventing from destroying the cell that houses them.

Extrinsic material to be attacked by lysosomal enzymes is brought into the interior of the cell through the process of endocytosis. If the fluid is internalized by endocytosis, the process is called pinocytosis. Endocytosis is also accomplished by phagocytosis.

In pinocytosis, ECF and a large molecule such as protein is engulfed. A specific molecule may bind to surface receptor, triggering pinocytosis - receptor-mediated endocytosis. Dynamin, a molecule forms rings wrapping around, severing the vesicle from the surface membrane in pinocytosis. In phagocytosis, large multimolecular particles are internalized by endocytosis; this is achieved by only a few specialized cells- white blood cells that play an important role in the body’s defense mechanism. When a leukocyte encounters large multimolecular particle, such as bacteria or tissue debris, it extends projection (pseudopodia) that completely surround or engulf the particle, forming an internalized vesicle that traps the large multimolecular particle within it. A lysosome fuses with the membrane of the internalized vesicle and releases its contents of hydrolytic enzymes into the vesicle. These enzymes safely attack the microbes or other trapped material within the enclosed confines of the vesicle without damaging the remainder of the cell.

Lysosomes can take up old organelles such as mitochondria and break down into their component molecules. Those molecules that can be released are reabsorbed into the cytosol, and the rest are dumped out of the cell. The process by which worn-out organelles are digested is called **autophagy** a human liver cell recycles about half its content every week.

In the inherited condition known as **lysosomal storage disease (Tay-Sachs disease)** lysosomes are not effective because they lack specific enzymes. As a result, harmful waste products accumulate disrupting the normal function of cells, often with fatal results

Peroxisome

- Peroxisome has oxidative enzymes that detoxify various wastes.
- Is shorter and smoother than lysosome; several hundreds present in one cell
- Is membrane-enclosed sacs containing enzymes
- Contains several powerful oxidative enzymes and catalase
- Oxidative enzymes need oxygen to remove hydrogen from specific substance/molecule; such reactions are important in detoxifying various waste products within the cell or foreign compounds that have entered in, such as ethanol consumed in alcoholic drinks.
- The major product generated is hydrogen peroxide; hydrogen peroxide itself is a powerful oxidant.
- Also contain catalase, and antioxidant enzyme decomposing hydrogen peroxide into harmless water and oxygen. This reaction is an important safety reaction that destroys deadly hydrogen peroxide, at the site of production, thereby preventing possible devastating escape into the cytosol.
- Peroximal disorders disrupt the normal processing of lipids and can severely disrupt the normal function of the nervous system by altering the structure of the nerve cell membrane

Mitochondria

Mitochondria are the “power houses” of the cell; they extract energy from nutrients in food and transform it into to usable form to energize cell activity. Their number varies with the cell, depending on the energy needs of each particular cell type. A single cell may have few hundreds or thousands. Mitochondria are rod or oval shaped about the size of a bacterium. Each is enclosed by a double membrane - a smooth outer that surrounds the mitochondria, and an inner membrane that forms a series of enfolding or

shelves called cristae, which project into an inner cavity filled with a jelly-like matrix (See figure 3). These cristae contain proteins that convert much of the energy in food into a usable form (the electron transport protein). The enfolding increase the surface area available for keeping these important proteins the matrix contains a mixture of hundreds of different dissolved enzymes (Citric acid cycle enzymes) that are important in preparing nutrient molecules for the final extraction of usable energy by the cristae proteins.

Carbon-hydrogen bonds in ingested food are the source of energy stored in the chemical forms. Body cell can extract energy from food nutrients and convert it into energy form that they can use. The high energy phosphate bonds of ATP contain adenosine with 3 phosphate groups. When high energy phosphate bond is split, a substantial amount of energy is released. ATP is the universal energy carrier the common energy “currency” of the body. Cells can “cash in” ATP to pay the energy “price” for running the cellular machine. To get immediate usable energy cells can split terminal phosphate bond of ATP, which yields ADP with phosphate group attached - plus inorganic phosphate (P_i) plus energy. (See figure 3)

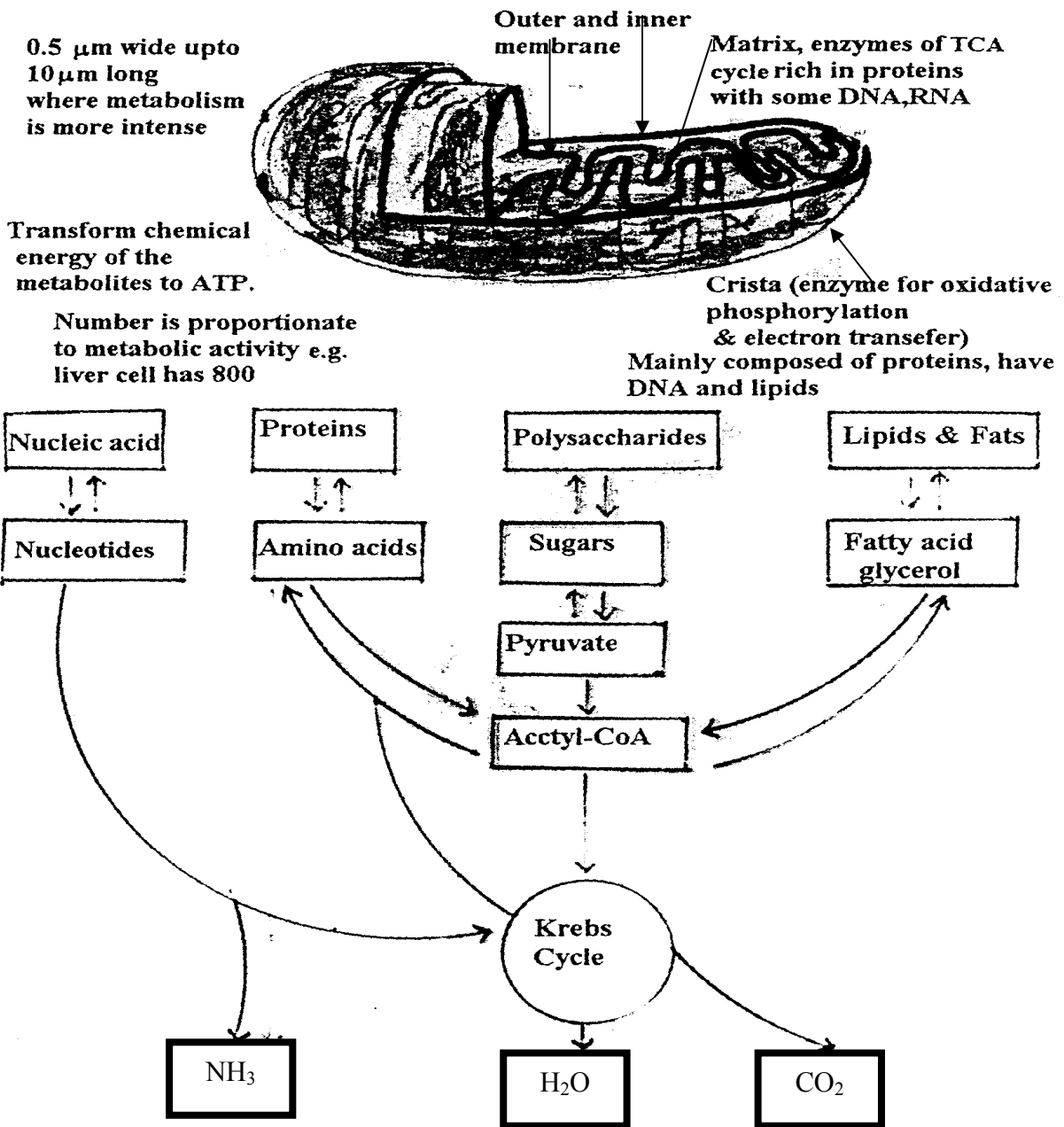

Figure 3. Structure of mitochondrion and the metabolic path ways of a cell.

Mitochondria are unusual organelles in two ways:

1. In the matrix they have their own unique DNA called mitochondrial DNA.
2. Mitochondria have the ability to replicate themselves even when the cell to which they belong is not undergoing cell division

Cytosol

The cytosol is semi-solid portion of the cytoplasm, surrounding the organelles and occupies about 5% of the total cell volume. The cytosol is important in intermediary metabolism, ribosomal protein synthesis, and storage of fat and glycogen. Dispersed throughout the cytosol is a cytoskeleton that gives shape to the cell, provides a framework, and is responsible for various cell movements.

Many intracellular chemical reactions involving degradation, synthesis, and transformation of small organic molecules such as simple sugars, amino acids, and fatty acids capturing energy for cellular function and for providing raw materials for the maintenance of the cellular structure and function and for cell growth. Thousands of enzymes involved in glycolysis and other intermediary biochemical reactions are found in the cytosol.

Ribosome

Free ribosomes synthesize proteins for use in the cytosol itself. The rough ER ribosomes synthesize proteins for secretion and for construction of new cellular proteins. Some free ribosomes are clustered as polyribosomes. Excess nutrient not used for ATP production are converted in the cytosol into storage form known as 'inclusions', the largest and the most important storage product is fat. In adipose tissue, the tissue specialized for fat storage, the stored fat molecules occupies almost entire cytosol, as one large fat droplet. The other storage product is glycogen, cells vary in ability to store glycogen, the liver and muscle cell having the largest stores. Stored glycogen and fat provide fuel for the citric acid cycle and electron transport chain, feeding the mitochondrial energy-producing machinery.

Cytoskeleton

The cytoskeleton is a complex protein network that act as the "bone and muscle" of the cell. This necessary intracellular scaffoldings supports and organizes cellular components arrangements and to control their movements; this provides distinct shape, size to the cell. This network has at least four distinct elements:

1. Microtubules
2. Microfilaments
3. Intermediate filaments
4. Microtubular lattice

The different parts of the cytoskeleton are structures linked and functionally coordinated to provide integration of the cell. The microtubule is the largest of the group; slender, long, hollow tubes composed of a globular protein molecule (6 nm diameter) tubulin. They provide asymmetrical shape to the cell, such as a neuron with cell body and long axon. They coordinate numerous complex cell movements in transport of secretory vesicles from region to region of the cell, movements of cilia and flagella, distribution of chromosomes during cell division, microfilaments are important to cellular contractile system and as mechanical stiffeners. The microfilaments are the smallest of the cytoskeleton composed of protein molecule actin having a globular shape similar to tubulin.

Plasma Membrane

The plasma membrane is extremely thin layer of lipids and proteins forming outermost boundary of living cell and enclosing the intracellular fluid (ICF). It serves as a mechanical barrier that traps needed molecules within the cell; plasma membrane plays an active role in determining the composition of cell by selective permeability of substances to pass between the cell and its ECF environment. There are some differences in the composition of plasma membrane between cell types, which permits the cell to interact in different ways with essentially the same extracellular fluid (ECF) environment. The plasma membrane is a fluid lipid bilayer embedded with proteins. It appears as 'trilaminar' layer structure having two dark layers separated by a light middle layer as a result of specific arrangement of the constituent molecules.

All plasma membrane are made up of lipids and proteins plus small amount of carbohydrate. Phospholipids are most abundant with a lesser amount of cholesterol. Phospholipids have a polar charged head having a negatively charged phosphate group

and two non-polar (electrically neutral) fatty acid tails. The polar end is hydrophilic (water loving) because it can interact with water molecule which is also polar, the non-polar end is hydrophobic (water fearing) and will not mix with water.

Such two-sided molecule self assemble into a lipid bilayer, a double layer of lipid molecules when in contact with water. The hydrophobic tails bury themselves in the center away from the water, while the hydrophilic heads line up on both sides in contact with water. The water surface of the layer is exposed to ECF, whereas the inner layer is in contact with the intracellular fluid (ICF). The lipid is fluid in nature, with consistency like liquid cooking oil. Cholesterol provides to the fluidity as well as the stability; cholesterol lies in between the phosphate molecules, preventing the fatty acid chain from packing together and crystallizing that could decrease fluidity of the membrane. Cholesterol also exerts a regulatory role on some of the membrane proteins. On account of fluidity of the membrane it gives flexibility to the cell to change its shape; transport process are also dependent on the fluidity of the lipid bilayer.

The membrane proteins are either attached to or inserted within the lipid bilayer; some extending through the entire membrane thickness; they have polar region at both ends joined by a non-polar central portion.

Other proteins are on either the outside or inner surface, anchored by interactions with proteins that spans the membrane or by attachment to the lipid bilayer. On account of membrane fluidity many proteins float freely, although the mobility of protein that have special function in a particular area of the membrane is restricted - this gives ever changing mosaic pattern of the protein embedded in the lipid layer. Only the outer surface of the plasma membrane contains a small amount of carbohydrate. Short-chain carbohydrates are bound primarily to membrane proteins and to a lesser extent to lipids, forming glycoproteins and glycolipids.

The plasma membrane is actually asymmetrical; the two surfaces are not the same; carbohydrate is only on the outer surface; different amount of different proteins are on the outer and inner surfaces and even the lipid structures of the outer and inner half is

not the same. The plasma membrane is highly complex, dynamic, regional differentiated structure. The lipid layer forms the primary barrier to diffusion, whereas proteins perform most of the specific membrane functions.

Lipid bilayer serves three functions:

Forms the basic structure of the membrane

Its hydrophobic interior/inner side is a barrier to passage of water-soluble substances between the ICF and ECF; water-soluble cannot dissolve in and pass through lipid bilayer.

Responsible for the fluidity of the membrane

Membrane Proteins

Membrane proteins are variety of different proteins within the plasma membrane; serve the following special functions: (see fig. 4)

1. Some form water-filled passage ways or channels, across the lipid bilayer; such channels allow ions to pass through without coming in direct contact with lipid interior. The channels are highly selective; they can selectively attract or repel particular ions. This selectively attracts or repels particular ions. This selectivity is to specific charged amino acids group. Number and kind of channels vary in cells. Channels open and close in response to a controlling mechanism.
2. Other proteins serve as carrier molecule that transport specific molecule that cannot cross on their own. They differ in cells, e.g., thyroid epithelial cell possesses carriers for iodine.
3. Many proteins on the outer surface serve as 'receptor sites' that recognize and bind with specific molecules in the cell environment. This binding triggers a series of membrane and intracellular events that alter the activity of the target cell. In this way hormones influence specific cell, even though every cell is exposed to the same chemical messenger via its widespread distribution by the blood
4. Another group of proteins act as membrane-bound enzymes that control specific chemical reactions on either side of the plasma membrane e.g., outer layer of the

plasma membrane of skeletal muscle contains enzyme ACh-esterase that destroys the chemical messenger that triggers contraction.

5. Some proteins are arranged as filaments network/meshwork on the inner side and are secured to certain internal protein elements of the cytoskeleton. They maintain cell shape.
6. Other proteins function as cell adhesion molecules (CAMs). These molecules protrude from the membrane surface that grip each other and grip the connective tissue fibers that interlace between cells.
7. Some proteins, especially in conjunction with carbohydrate are important in the cell's ability to recognize 'self' and in cell-to-cell interactions.

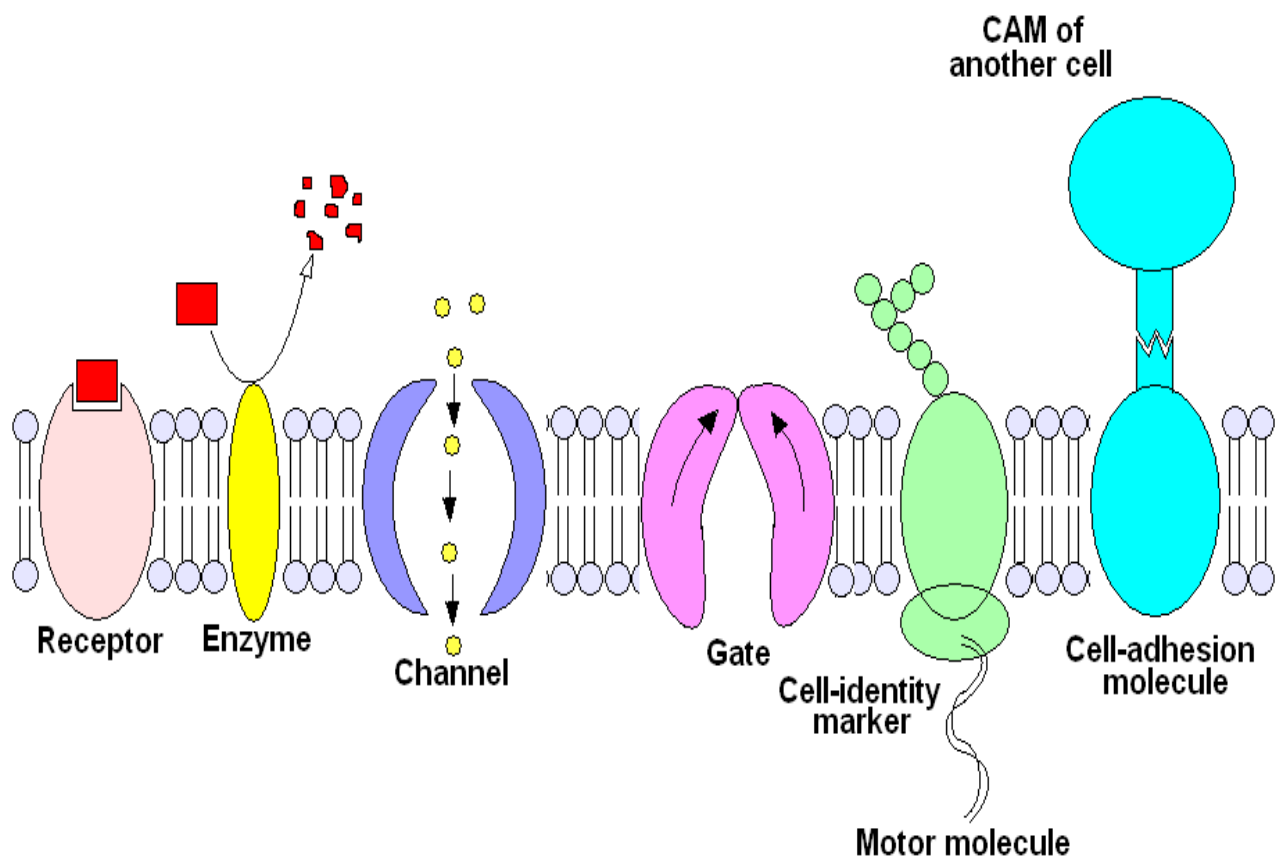

Figure 4. Different types of membrane proteins

Membrane Carbohydrate

Short-chain carbohydrate on the outer membrane surface serves as self-identity marker enabling cells to identify and interact with each other in the following ways:

- Recognition of “self” and cell-to-cell interactions. Cells recognize each other and form tissues; complex carbohydrates act as a “trademark” of a particular cell type, for recognition.
- Carbohydrate-containing surface markers are important in growth. Cells do not overgrow their own territory. Abnormal surface markers present in tumor cells, and abnormality may underline uncontrolled growth.
- Some CAMS have carbohydrate, on the outermost tip where they participate in cell adhesion activity.

Membrane Transport

Lipid-soluble substances and small ions can passively diffuse through the plasma membrane down their electro-chemical gradients. The plasma membrane is selectively permeable. Highly lipid-soluble particles are able to dissolve in the lipid bilayer and pass through the membrane. Uncharged/non-polar molecules oxygen, carbon dioxide and fatty acids are highly lipid-soluble and readily permeate the membrane. Charged particle sodium/potassium ions and polar molecules such as glucose and proteins have low lipid solubility, but are very soluble in water. For water-soluble ions of less than 0.8 nm diameter, protein channels serve as an alternate route for passage. Ions for which specific channels are available can permeate the plasma membrane. Particles with low lipid-permeability and too large for channels, cannot permeate the membrane on their own.

Some force is needed to produce movement across the plasma membrane.

Two forces are involved:

1. Forces that do not require the cell to expend energy for movement - passive force
2. Forces requiring energy (as ATP) to be expended to transport across the membrane - active force

Diffusion down a concentration gradient

All molecules in liquid and gases are in continuous random motion as they have more room to move before colliding with another. Each molecule moves separately and randomly in any direction. As a result of this haphazard movement, the molecules frequently collide bouncing off each other in different directions. The greater the concentration, the greater the likelihood of collision. Such a difference in concentration in molecules between two adjacent areas is chemical /concentration gradient. The net movement of the molecule by diffusion will be from the higher area of concentration to the area of lower concentration. Certain factors in addition to the concentration gradient influence the rate of net diffusion across a membrane. These include the:

1. magnitude of the concentration gradient
2. permeability of the membrane to the substance
3. surface area of the membrane to the substance
4. molecular weight of the substance: lighter diffuse rapidly
5. distance through which diffusion must take place

Increasing all the factors increases rate of net diffusion, except distance - thickness, that if increased, decreases the rate of diffusion; and molecular weight if increased, decreases rate of diffusion.

Movement along electrical gradient

Movement of charged particles is also affected by their electrical gradient. Like charges repel each other, whereas opposite charges attract each other. If a relative difference in charges exist between two adjacent areas, the cations tend to move towards more negatively charged area, whereas the anions tend to move toward the more positively charged areas. The simultaneous existence of an electrical and concentration (chemical) gradient for a particular ion is referred to as an electro-chemical gradient.

Osmosis

Osmosis is the net diffusion of water down its own concentration gradient. Water can readily permeate the plasma membrane. The driving force for diffusion of water is its

concentration gradient from area of higher water concentration (low solute) to the area of lower water (high solute) concentration. This net diffusion of water is known as osmosis. Special mechanisms are used to transport selected molecules unable to cross the plasma membrane on their own.

Carrier- Mediated Transport

All carrier proteins span the thickness of the plasma membrane and are able to undergo reversible changes in shape so that specific binding site can alternately be exposed at either side of the membrane. As the molecule to be transported attaches to a binding site on the carrier on one side of the membrane, it triggers a change in the carrier shape that causes the same site to be exposed to the other side of the membrane. Their having movement in this way, the bound molecule detaches from the carrier. This transport displays three characteristics:

1. **Specificity:** Each cell possesses protein specified to transport a specific substance or few closely-related chemical compounds amino acid cannot bind to glucose carrier, but similar amino acids may use the same carrier. Type of carriers vary in cells. A number of inherited disorders involve defects in transport system for a particular substance.
2. **Saturation:** In a given time only a limited amount of a substance can be transported via a carrier; limited number of carrier site are available within a particular plasma membrane for a specific molecule. This limit is known as transport maximum (T_m). The substance's rate of transport across the membrane are directly related to its concentration. When the T_m is reached, the carrier is saturated, and the rate of transport is maximum. Further increase in the substance concentration is not accompanied by corresponding increase in the rate of transport. Saturation of carrier is a critical rate-limiting factor to the transport of selected substances across the plasma membrane in kidney and the intestine. There is a mechanism to increase the number of carriers in the plasma membrane.
3. **Competition:** Several closely related compounds may compete for ride across the plasma membrane on the same carrier.

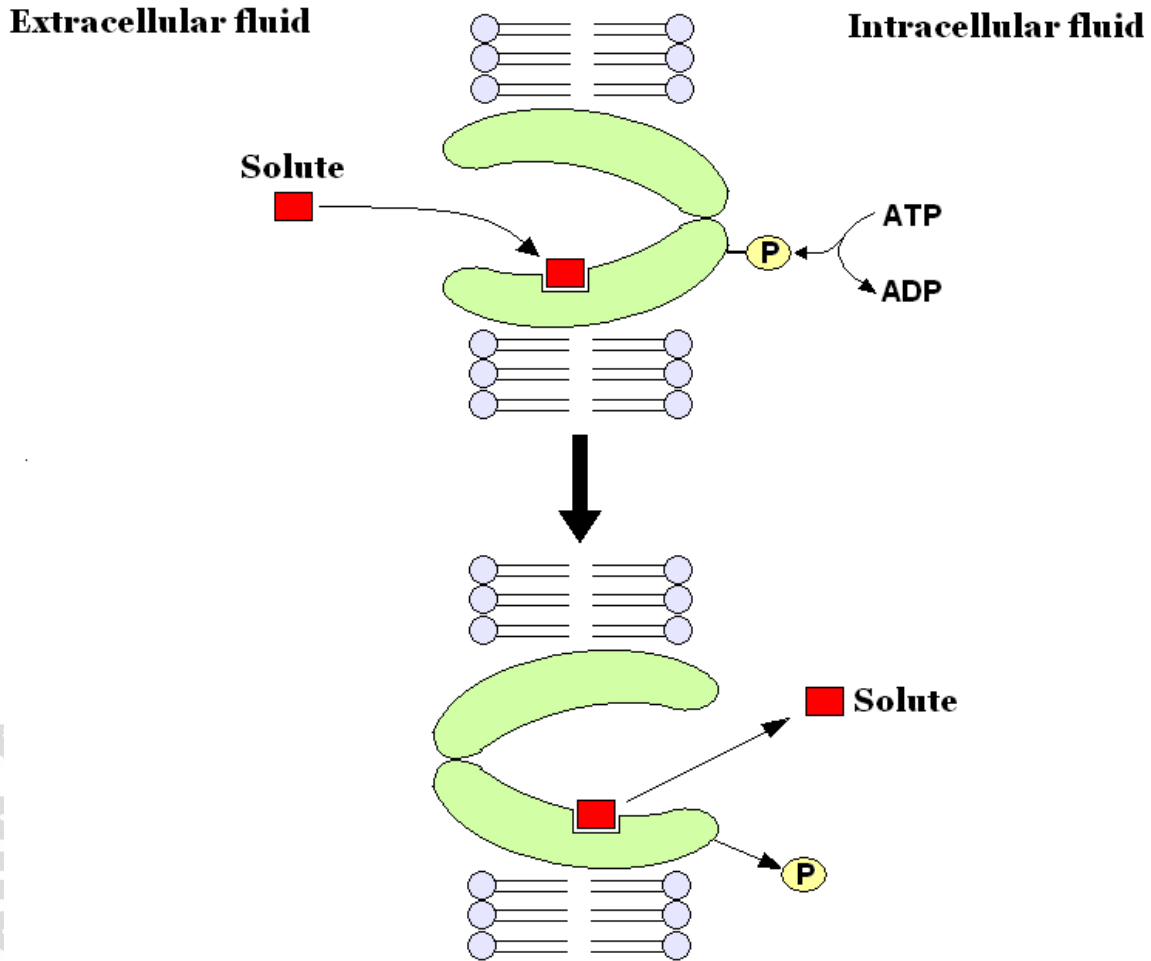

Figure 5. Primary active transport process

Facilitated Diffusion

Facilitated diffusion uses a carrier protein to facilitate the transfer of a particular substance across the membrane “downhill” from higher to lower concentration. This process is passive and does not require energy because movement occurs naturally down a concentration gradient. Active transport, on the other hand, requires the carrier to expend energy to transfer its passenger “uphill” against a concentration gradient from an area of lower concentration to an area of higher concentration. Active transport requires protein carrier to transfer a specific substance across the membrane, transporting against concentration gradient. Carrier phosphorylation increases the affinity for its passenger. The carrier has ATPase activity splitting high-energy phosphate from an ATP to yield ADP plus a free P_i. This phosphate group gets bound to the carrier.

(see fig. 5). Phosphorylation and binding of particle on the low concentration side induces a conformational change in the carrier protein so that passenger is now exposed to the high concentration side of the membrane. This change in carrier shape is accompanied by dephosphorylation. Removal of phosphate reduces the affinity of the binding site for the passenger, so the passenger is released on the high concentration side. The carrier then returns to the original conformation. This active transport mechanisms are often called 'pumps', analogous to lift water by pump that need energy to lift water against the downward pull of gravity; Hydrogen-pump, Na-K-ATPase pump (Na-K-Pump).

Na⁺-K⁺-pump plays three important roles

1. It establishes sodium and potassium concentration gradients across the plasma membrane of all cells; these gradients are important in the nerve and muscle to generate electrical signals.
2. It helps regulate cell volume by controlling the concentration of solutes inside the cell and thus minimizing osmotic effects that would induce swelling or shrinking of the cell.
3. The energy used to run the pump also indirectly serves as the energy source for the co-transport of glucose and amino acids across the membrane (intestine and kidney cell).

Vesicular Transport

The special cell membrane transport system selectively transports ions and small polar molecules. But large polar molecules and even multimolecular material may leave or enter the cell, such as hormone secretion or ingestion of invading microbe by leukocytes. These materials cannot cross the plasma membrane but are to be transferred between the ICF and ECF not by usual crossing but by wrapped in membrane. This process of transport into or out of the cell in a membrane-enclosed vesicle is - vesicular transport. Transport into the cell is termed endocytosis, whereas transport out of the cell is called exocytosis. In endocytosis, the transported material is wrapped in a piece of the plasma membrane, thus gaining entrance to the interior of the

cell. Endocytosis of fluid is called pinocytosis (drinking), whereas endocytosis of large multimolecular particles is known as phagocytosis (cell eating).

An engulfed vesicle has two possible fates inside the cell:

1. In most cases, lysosomes fuse with the vesicle to degrade and release its contents into the ICF
2. In some cells, endocytic vesicles bypass the lysosome and travel to the opposite side of the cell, where they release their contents by exocytosis. This way intact particles shuttle through the cell. Some materials are transferred through the thin capillary walls of cells, between the blood and surrounding tissue fluid.

Exocytosis is the reverse of endocytosis, in which a membrane-enclosed vesicle formed within the cell fuses with the plasma membrane, then opens up and releases its contents to the exterior. Such materials are packaged for export by the endoplasmic reticulum and Golgi complex.

Exocytosis serves two different purposes:

1. It is a mechanism for secreting large polar molecules, such as protein molecules and enzymes that cannot cross the plasma membrane. The vesicular contents are highly specific and are released only upon receipt of appropriate signals.
2. It enables the cell to add specific components to the plasma membrane, such as carriers, channels, or receptors depending on the cell's need.

The rate of endocytosis and exocytosis is maintained in balance to maintain a constant membrane surface area and cell volume.

More than 100% of the plasma membrane may be used in an hour to wrap internalized vesicles in a cell actively involved in endocytosis, needing rapid replacement of surface membrane by exocytosis. Both exocytosis and endocytosis require energy and are active mechanisms. In some cases of endocytosis, receptor sites on the surface membrane recognize and bind with specific molecules in the environment of the cell.

This combination triggers selected trapping of the bound material. Antibodies attach to the bacteria forming a coat that can be recognized by the specific receptor sites in the plasma membrane of the phagocytic leukocyte. Such “marked” or opsonized bacteria are quickly engulfed and destroyed. Exocytosis too is a triggered event. A specific neural or hormonal stimuli initiates opening of calcium channels in the membranes of secretory cell. Calcium influx increases cytosolic calcium levels triggering fusion of the exocytic vesicle with plasma membrane and subsequent release of its secretory products.

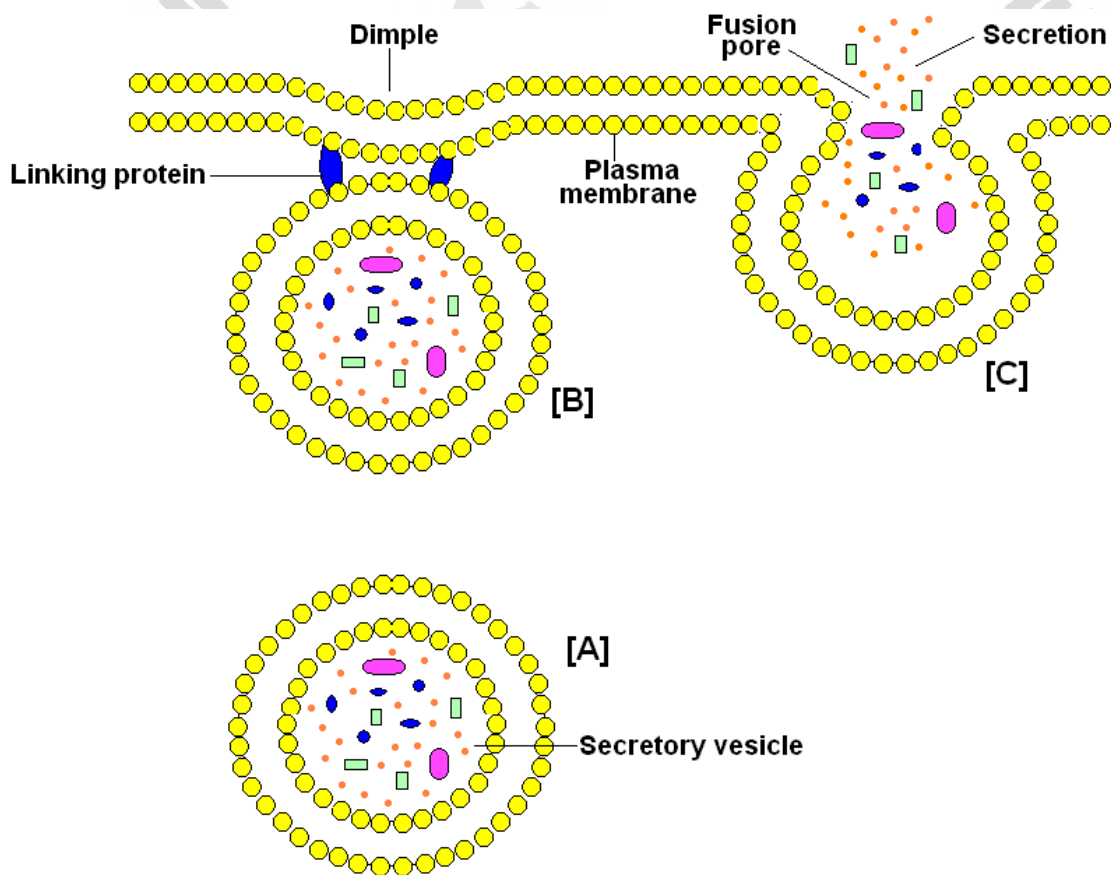

Figure 6. The process of exocytosis

Caveolae

Role in membrane transport and signal transduction: the outer surface of the plasma membrane is not smooth; it has tiny, cave-like indentations known as caveolae (tiny caves). These are small flask-shaped pits. In 1990S, it was suggested that they have the following role:

1. Provide a new route for transport into cell, and
2. Serve as “switch board” for relaying signals from many ECF chemical messengers into the cell interior.

INTERCELLULAR COMMUNICATION AND SIGNAL TRANSDUCTION

Communication is critical for the survival of cells that collectively compose the body. Coordination of diverse activities to maintain homeostasis requires the cells to communicate with each other. There are three types of communications “between cells”.

1. The most intimate communication is through gap junctions, which are minute tunnels that bridge the cytoplasm of nearby cells. Small particles and ions are directly exchanged, between interacting cells without ever entering the ECF. Gaps are important in permitting spread of electrical signals from one cell to the next in cardiac and smooth muscle.
2. The presence of signaling molecules on the surface membrane of some cells gives them ability to directly link up and interact with certain other cells in a special way. Thus phagocytic cells recognize and selectively destroy only undesirable cell, such as invading microbes while sparing the body’s own cell.
3. Intercellular chemical messenger is the commonest means by which cells communicate with each other. These chemicals messengers are paracrines, neurotransmitters, hormones, and neurohormones. On appropriate signals these molecules are released into the ECF, where these signaling agents act on target cell. These messengers have different sources.

(a) Gap junctions

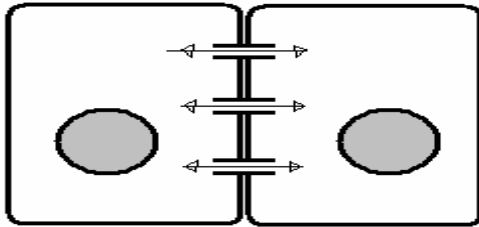

(b) Autocrine and paracrine signals

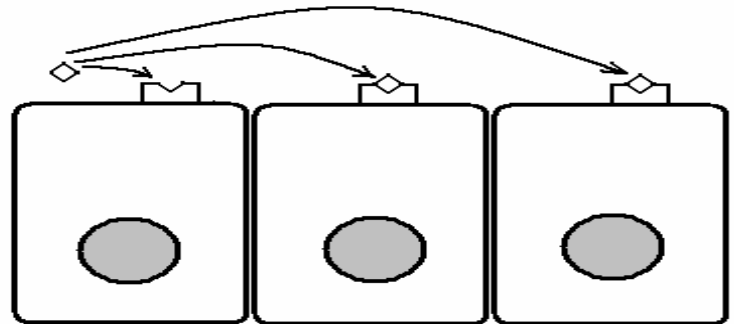

(c) Hormone

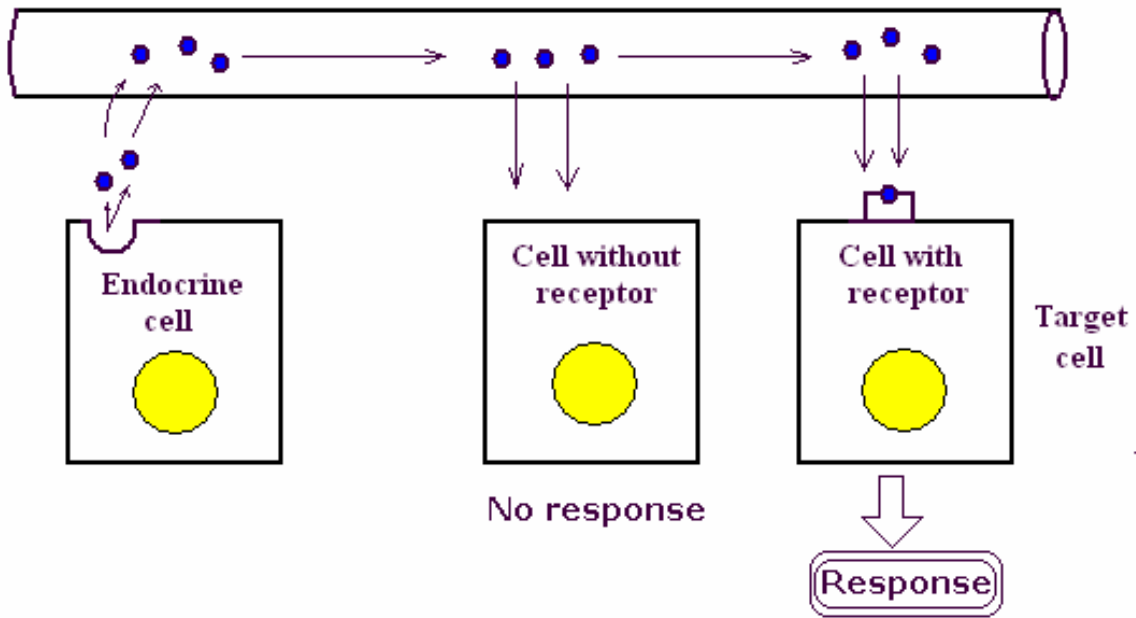

(d) Neurotransmitter

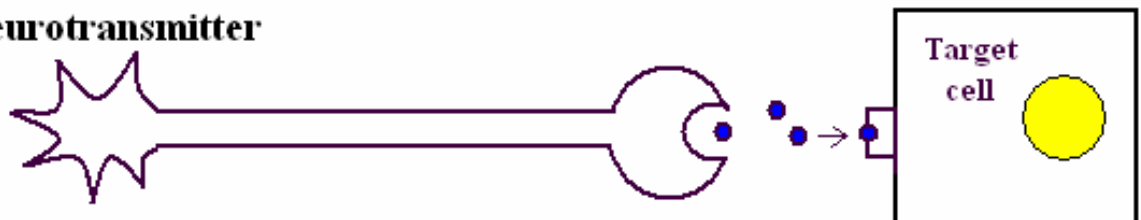

Figure 7. Various ways of cell-to-cell communication

Signal Transduction

Binding on chemical messenger to membrane receptors brings about a wide range of responses in different cells through only a few similar pathways used.

Dispersed within the outer surface on the plasma membrane of cell (muscle/ nerve/ gland) are specialized protein receptors that bind with the selected chemical messenger - neurotransmitter, hormone, or neuro-hormone, that are delivered by the blood or a neurotransmitter released from the neuron.

The chemical messenger binds with receptor triggering a sequence of intracellular events that ultimately influence/control a particular cellular activity important in the maintenance of homeostasis, such as membrane transport, secretion, metabolism, or contraction. There are wide ranging responses, but there are mainly two ways by which binding of the receptor with extracellular chemical messenger bring about the desired effects.

1. By opening or closing of specific channels in the membrane regulating a particular ion to move in or move out of the cell, or
2. By transferring the signal to an intracellular chemical messenger (the second messenger), which is turn triggers a preprogrammed series of biochemical events within the cell. Post-receptor events are fairly common.

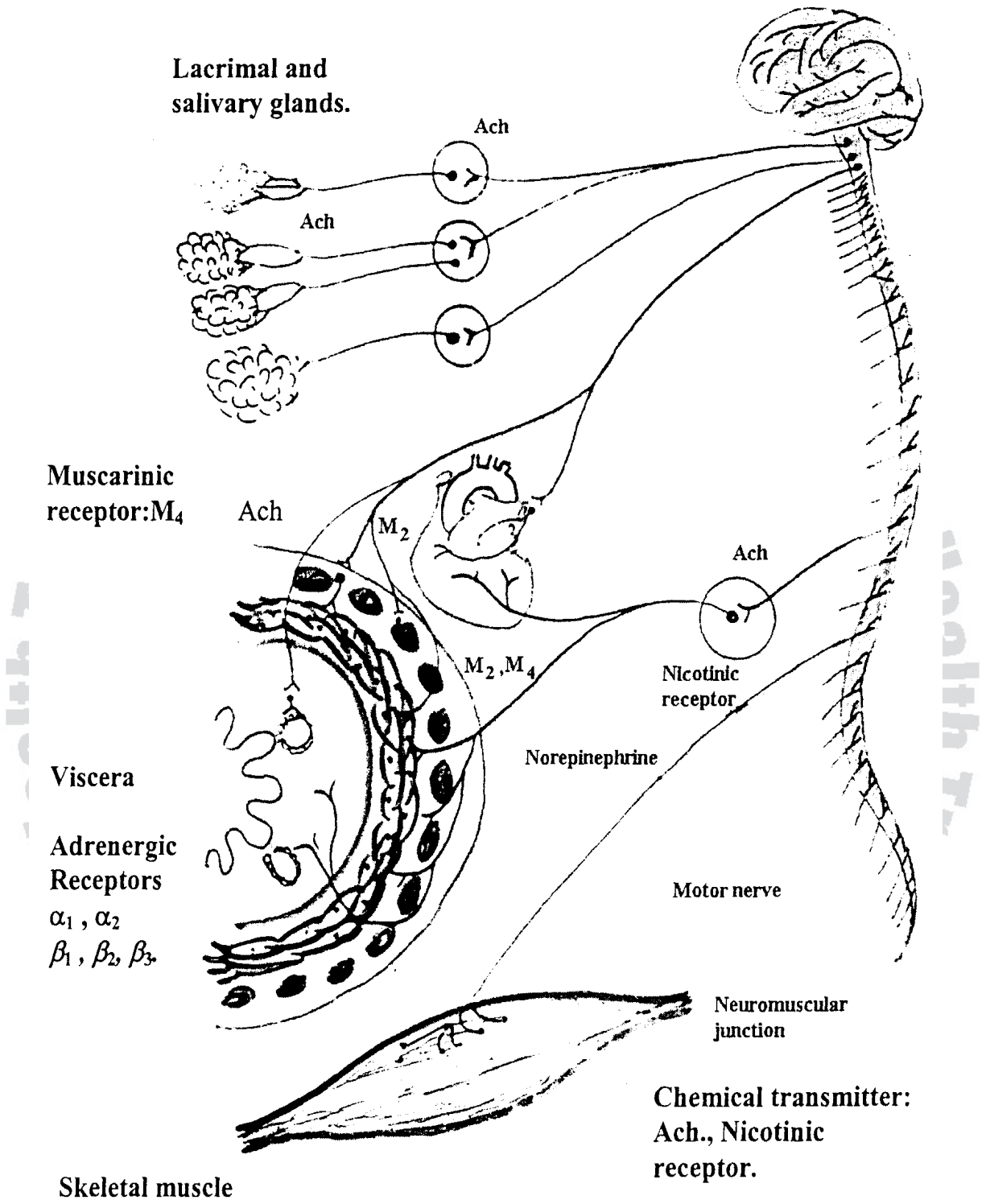

Figure 8. Neural transmission or communication at synaptic junction using neurotransmitters.

Major endocrine glands and their hormones.

Peptides, dopamine
(Hypothalamic hormone)

- Corticotropin - RH
- Gonadotropin - RH
- Growth hormone - RH
- Somatostatin
- Prolactin - RH
- Prolactin inhibiting hormone (PIH, dopamine)

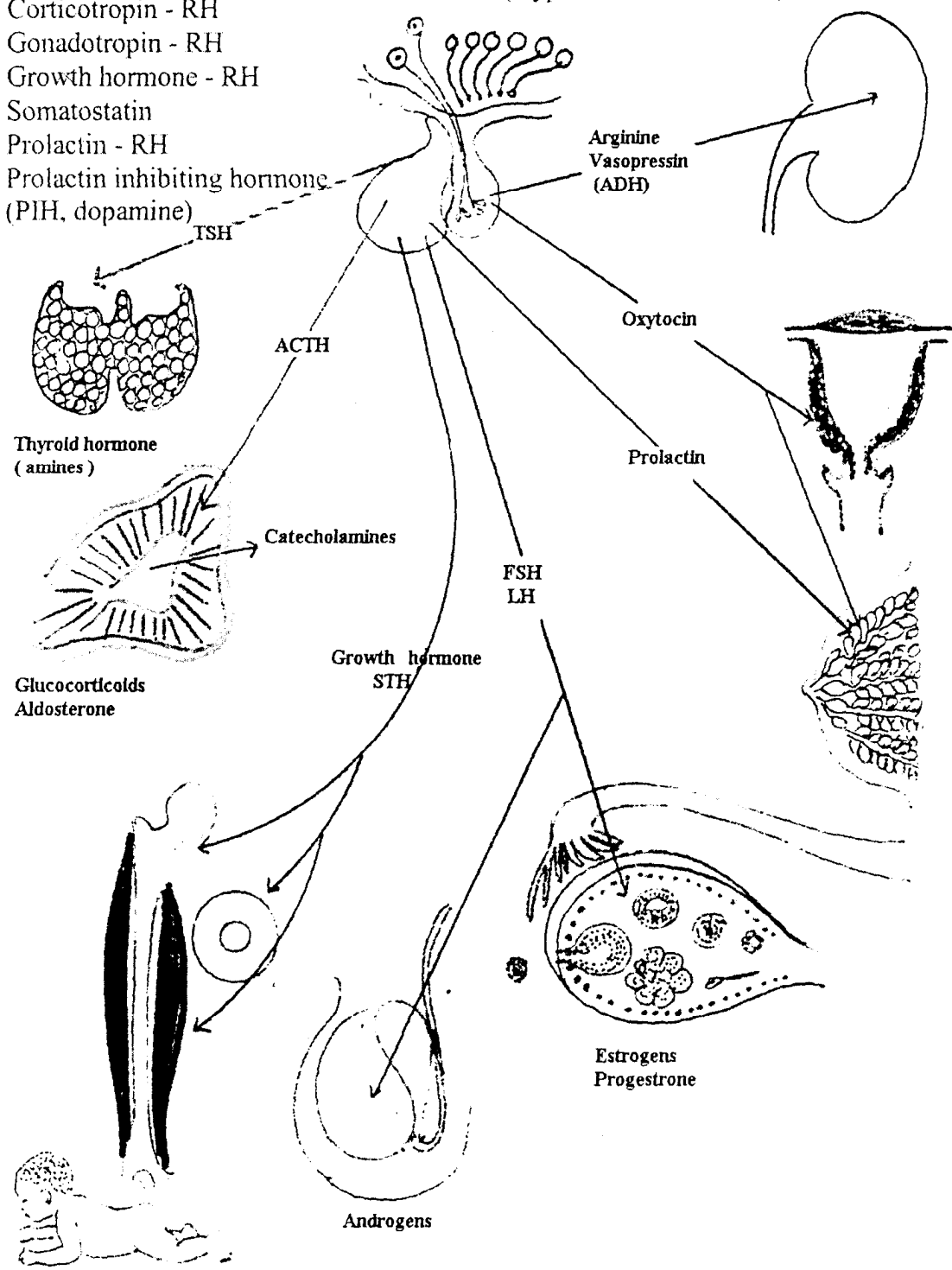

Figure 9. Endocrine communication using hormones as messenger..

Activation of Second Messenger System at Extracellular space (first)

Chemical Messenger: Many extracellular chemical messengers cannot actually enter their target cells to initiate the desired intracellular response/effects. The first chemical messenger binds with receptor on the surface membrane and then issue their orders - "pass it on" process. The first messenger binds to a membrane receptor, that combination serves as a signal for activation of an intracellular second messenger that ultimately relays the order through a series of biochemical intermediaries to specific intracellular proteins that carry out the dictated response, such as changes in cellular metabolism or secretory activities. This mechanism utilized is similar the variability in response depends on the specialization of the cell.

Second Messenger Pathways: There are two major second messenger pathways, one using adenosine monophosphate, cyclic- AMP or C-AMP, as a second messenger, and the other employs ionic calcium in this role (see fig. 10&11).

- The two pathways have much in common
- The chemical messenger binds with membrane –associated receptor leading to a series of biochemical steps, to activate an enzyme system on the inner side of the plasma membrane
- This enzyme, in turn activates intracellular second messenger that diffuses throughout the cell to trigger the appropriate cellular responses.
- In both pathways, the cellular response is achieved by altering the structure and function of a particular cell proteins - a particular enzyme activity is either increased or decreased.

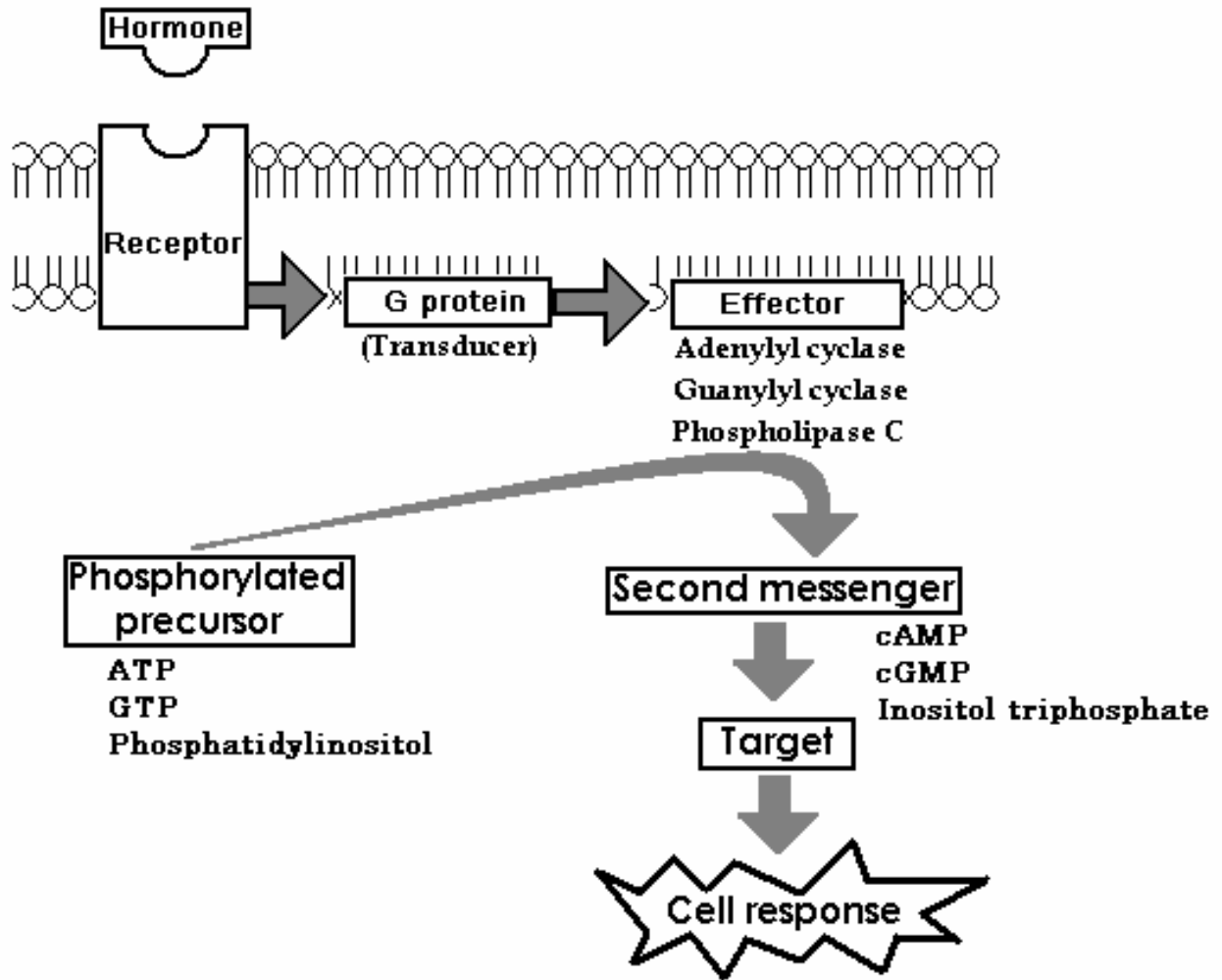
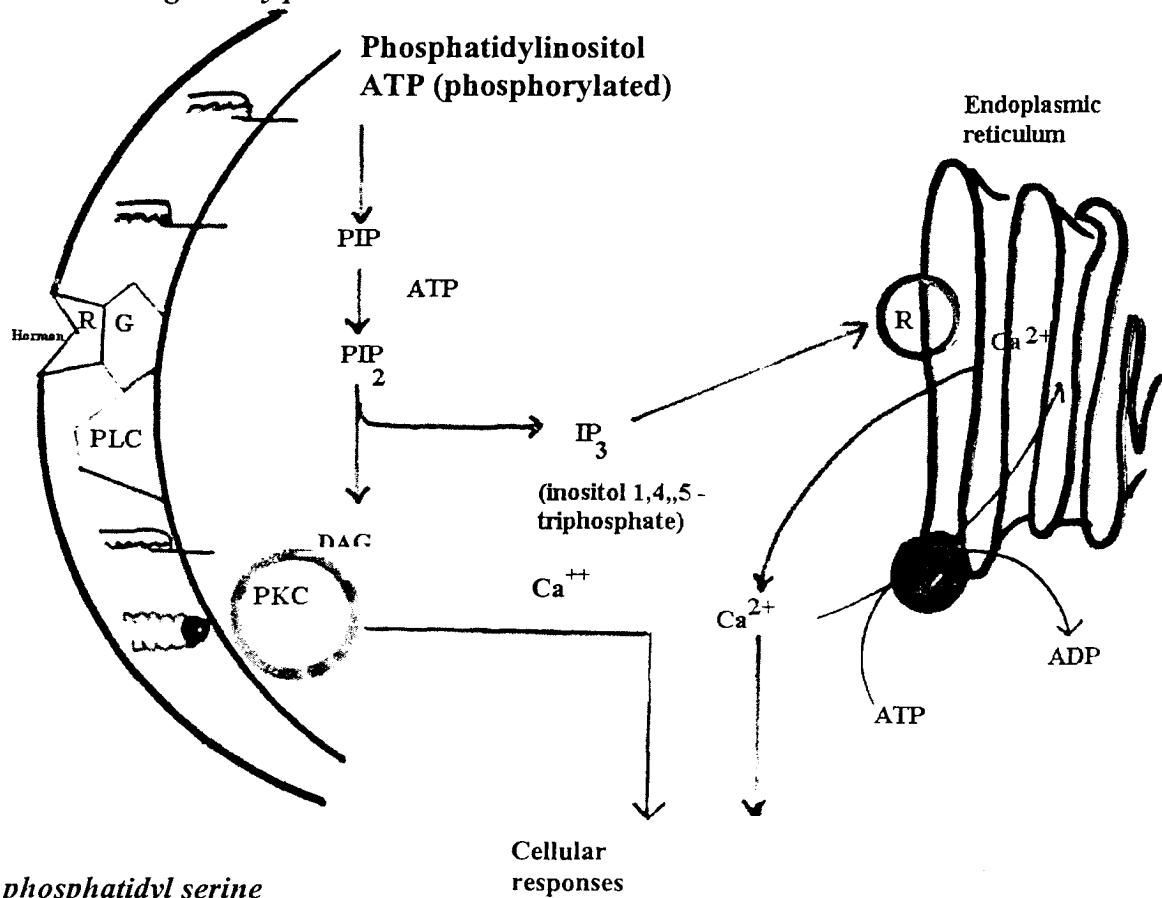

Figure 10. Signal transduction pattern common to second messenger system

PLC = Phospholipase C enzyme

R = receptor

G = GTP - regulatory protein



PS = phosphatidyl serine

PKC = enzyme protein kinase

Figure 11. Signals operating through the phosphoinositide system

Ethionine • Ethionine

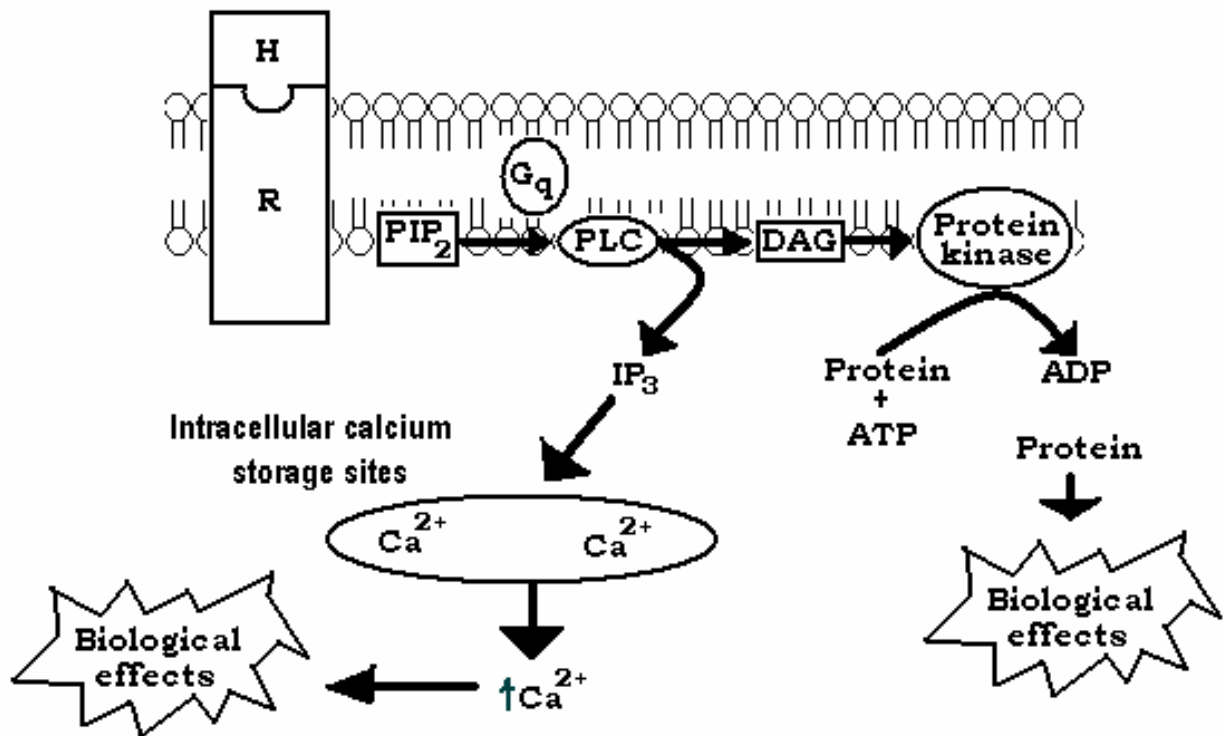

Figure 12. The phosphatidylinositol second messenger system

HOMEOSTATIC CONTROL

The human body is a self-controlling unit. Biological control systems have their own complexities and the enormous range and time scale over which they operate. The physiology of the various body systems is inseparable from homeostatic control mechanisms. Many step intracellular chemical events that amplifies a single irritating event is amplified thousands of times. In nervous system, millions of neurons may be involved in as simple act as walking up stairs. Some intracellular regulatory processes operate at the size scale of individual molecules or ions. On the other hand, of the time and size, the development plan of the human body by the endocrine system involves billions of cells, fulfilled on a time scale of decades.

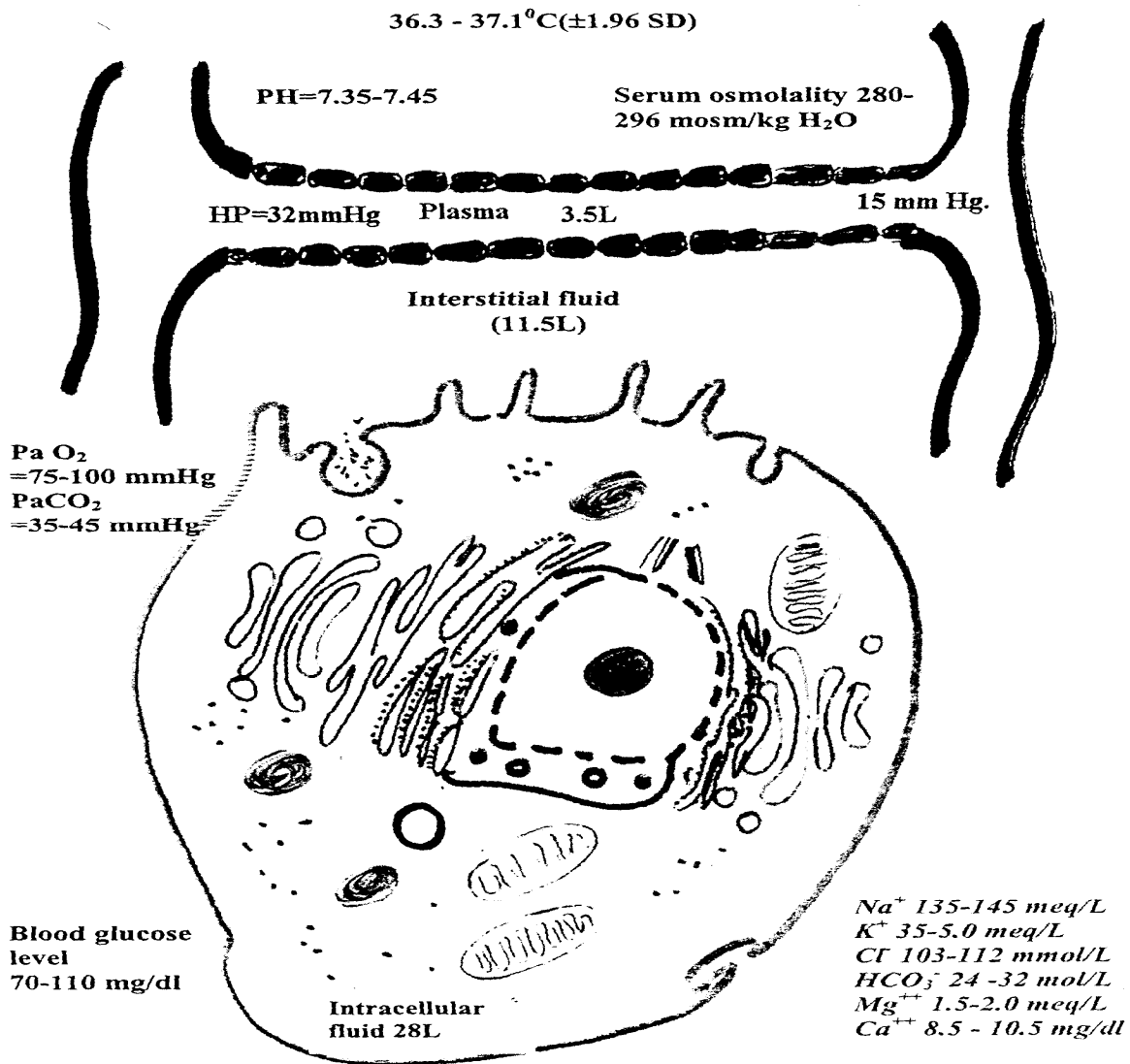

Figure 13. Shows consistency of internal environment of the cell

Some terms Used in Control System

A "System" is a set of components related in such a way as to work as a unit.

A "control System" is so arranged as to regulate itself or another system

Some terms used in control systems

A "system" is a set of components related in such a way as to work as a unit.

A "control system" is so arranged as to regulate itself or another system

An “**input**” is the stimulus applied to a control system from a source outside the system so a

to produce a specified response from the control system.

An “**output**” is the actual response of a control system.

An “**open loop**” control system is one in which the control action depends on (is a function of) output.

A “**negative feedback**” system is one in which the control action is a function of output in such a way that the output inhibits the control system

A “**positive feedback system**” is a closed loop control system in which the output accelerates the control system.

All negative feedback system has a controlled variable that is the factor (in the case of homeostasis functions) that the system is designed to maintain.

All feedback systems, negative or positive, have a sensor element capable of detecting the concentration of the controlled variable; information gained by the sensor is used to determine the output of the controlling system.

Therefore, in a feedback system, there is a sensor element, which detects the concentration of the controlled variable; there is a reference input, which defines the proper control level; and there is an error signal, which is a function of the difference between what the sensor senses the controlled variable and what the reference input determines it should be. The magnitude of the error signal and the direction of its deviations (negative or positive) determine the output of the system. The reference point can be considered the “set point” of the system.

Feedback Mechanisms

General Properties of Negative Feedback: Homeostasis demands that important physiological parameters, such as pH, body temperature, body fluids volume and composition, and blood pressure must be maintained with an appropriate limits/range. (See Figure 13). When a controlled variable departs from its appropriate value, negative

feedback provides the means for opposing the deviations. The ideal level of a controlled variable (parameter) is defined as its 'set- point'. The controlled variable is monitored by specific sensors/receptors that transmit information to an integrator (control center), which compares the sensor's input with the set-point value. Any deviations from the acceptable value/range gives rise to an ' error signal' when there is a difference between the set point and the value indicated by sensor/receptor. An error signal results in activation of effectors that opposes the deviation from the set point. The term 'negative' is used because the effector's response opposes the departure from the set point. The effector's response completes a feedback loop that runs from the controlled variable through the sensor to the integrator and back to the controlled variable by way of the effectors. All such systems are called 'closed loop systems'. (See figure14, 15 &16).

The set point in physiological system may be changed from time-to-time. For example, body temperature is regulated at lower value during sleep and at a higher level during fever. In women, body temperature also varies predictably during the menstrual cycle. The error signal is proportional to the difference between the set point and the value of controlled variable. Thus, the body's effectors are usually capable of making larger or smaller efforts, depending on the magnitude of the error signal.

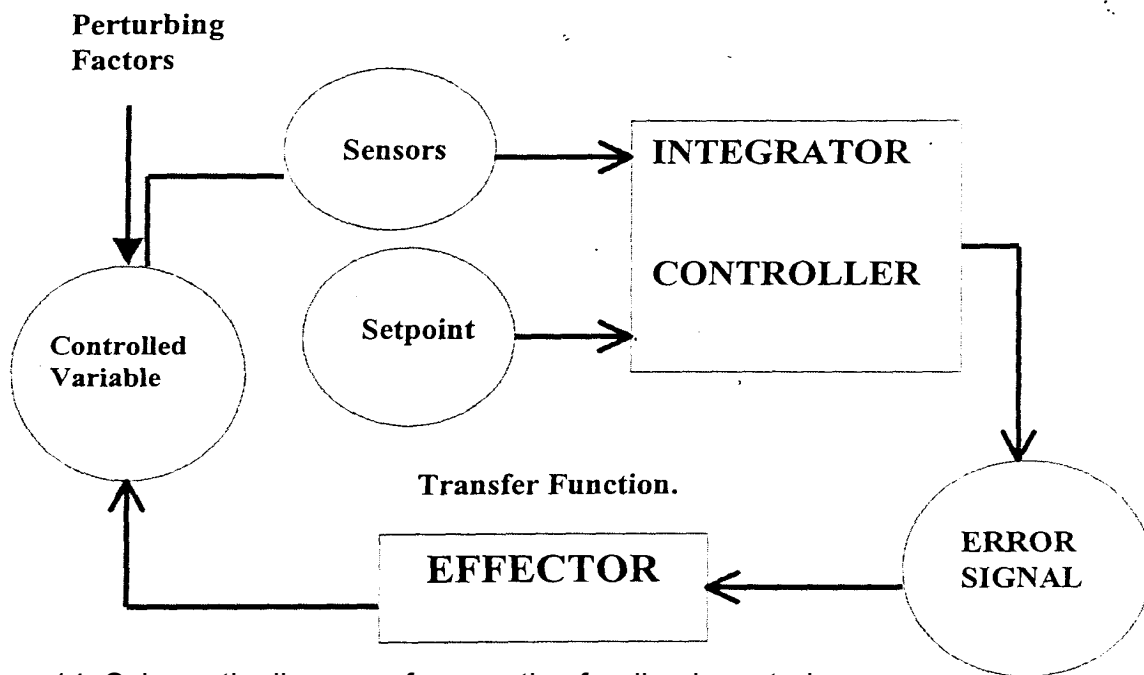

Figure 14. Schematic diagram of a negative feedback control

Open Loop system

Open loop system don't have negative feed back character. Open loop system can result from disease or damage to some part of the feedback loop. For example, damage to parts of the motor control system of the basal ganglia may result in uncontrolled body movements, as in Parkinson's disease. In some physiological systems, open loop systems are part of normal function. Body movements that must occur very rapidly, such as eye movement to follow an object when the head moves, or the boxer's quick punch in fighting, must be carried out according to a learned pattern because they must be completed before feedback could be effective. The skill attained

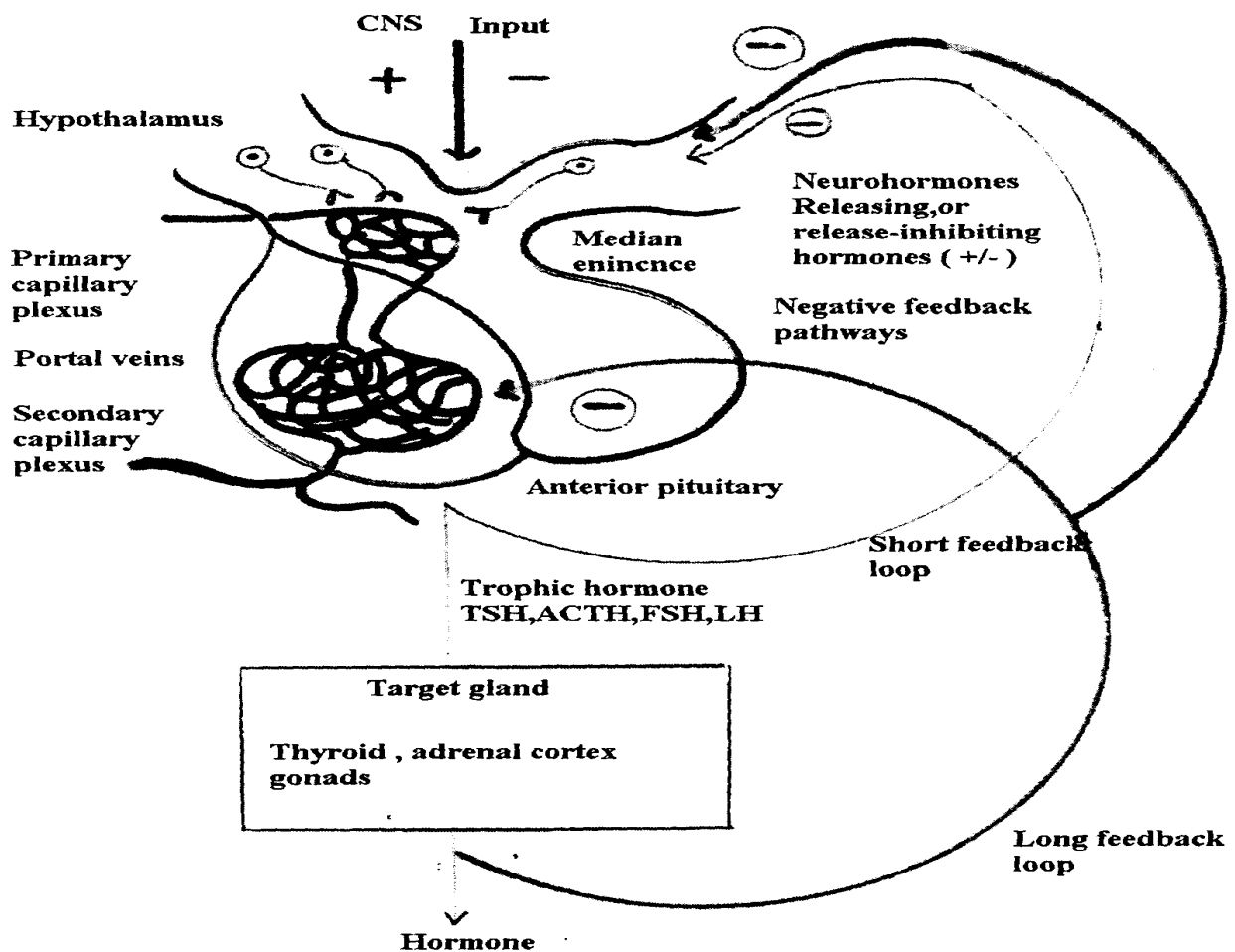

Figure 15. shows negative feedback pathways for pituitary hormones

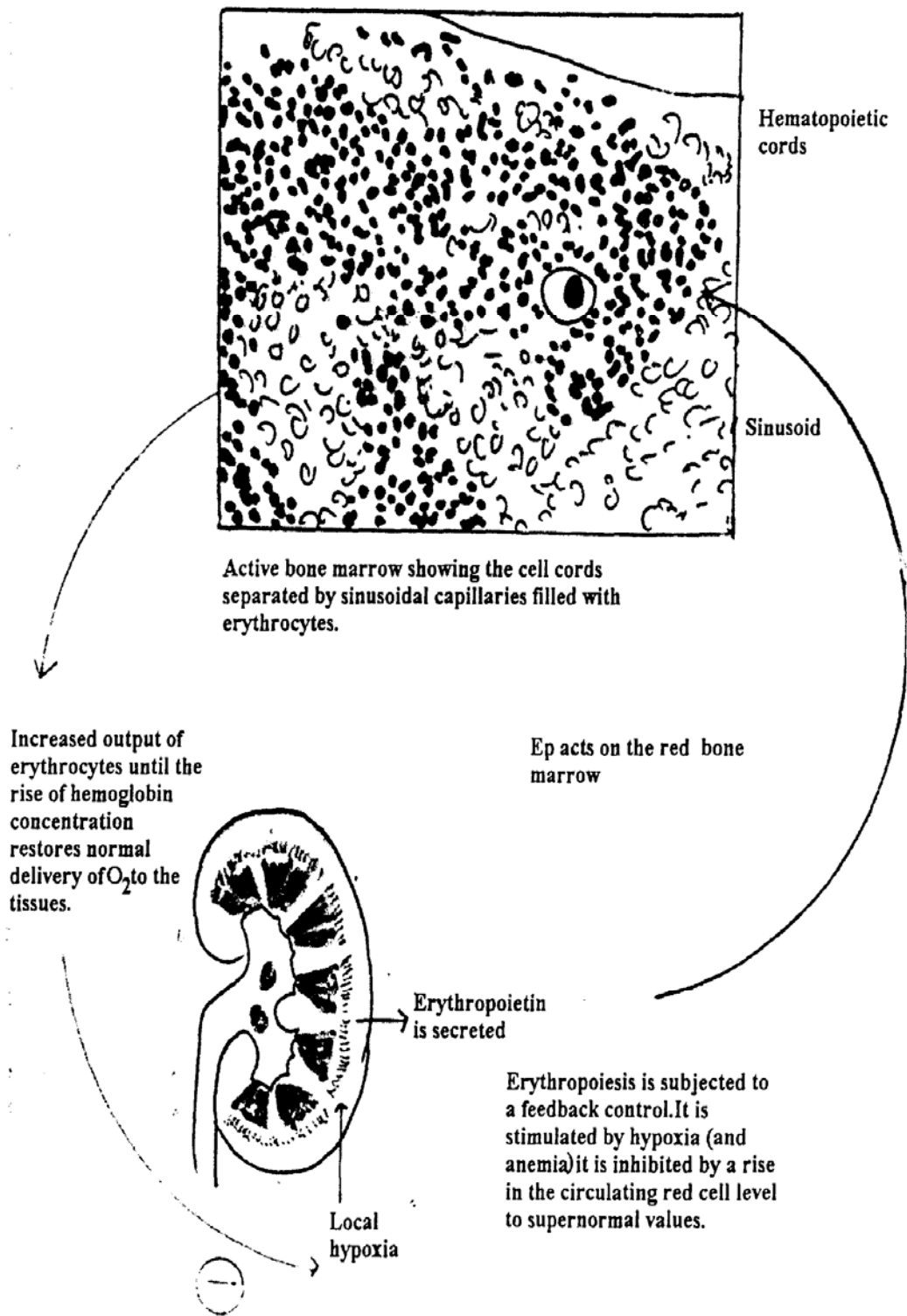

Figure 16. Shows negative feedback control of Red blood cell production.

Positive Feedback

Negative feedback stabilizes variables near their set point because the effectors response minimizes the error signal. Positive Feedback:

- A change in the controlled variables causes the effectors to drive it further away from the initial value of the variable/parameter
- Systems are highly unstable
- Effect is like that of a spark igniting an explosion.
- Is an undesirable trait in physiological systems
- Often occurs in disease, where it results in very rapid deterioration of homeostasis, e.g. in certain heart disease, the heart becomes overloaded, cannot pump out all the blood returning to it - the volume of the heart increases and this volume further increases - diminishes the ability of the heart to pump blood; the end result - is the unstable positive feedback loop with dangerous consequences for the patient
- Positive feedback is not always abnormal. It is put in use for specific purpose, such as:
 - Depolarization phase of action potential. (See Figure 17).
 - Mid-cycle surge of LH and FSH initiated by increased estrogen levels
 - Response of immune system to virus and bacteria
 - Important in expulsive processes: uterine contraction during child birth, micturition and defecation. (See Figure 18).

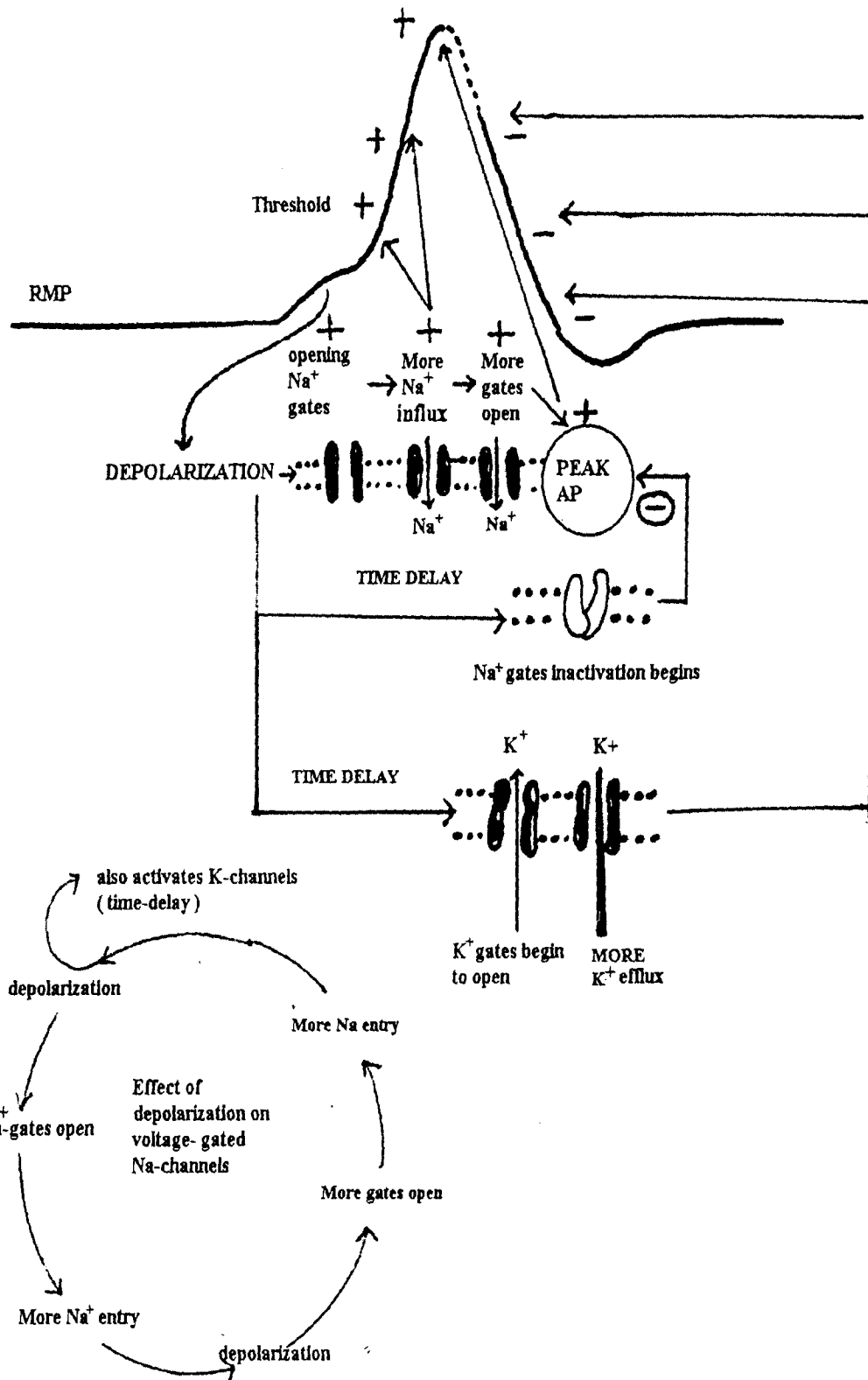

Figure 17. Shows the positive feedback mechanism contributes to the rising phase of action potential.

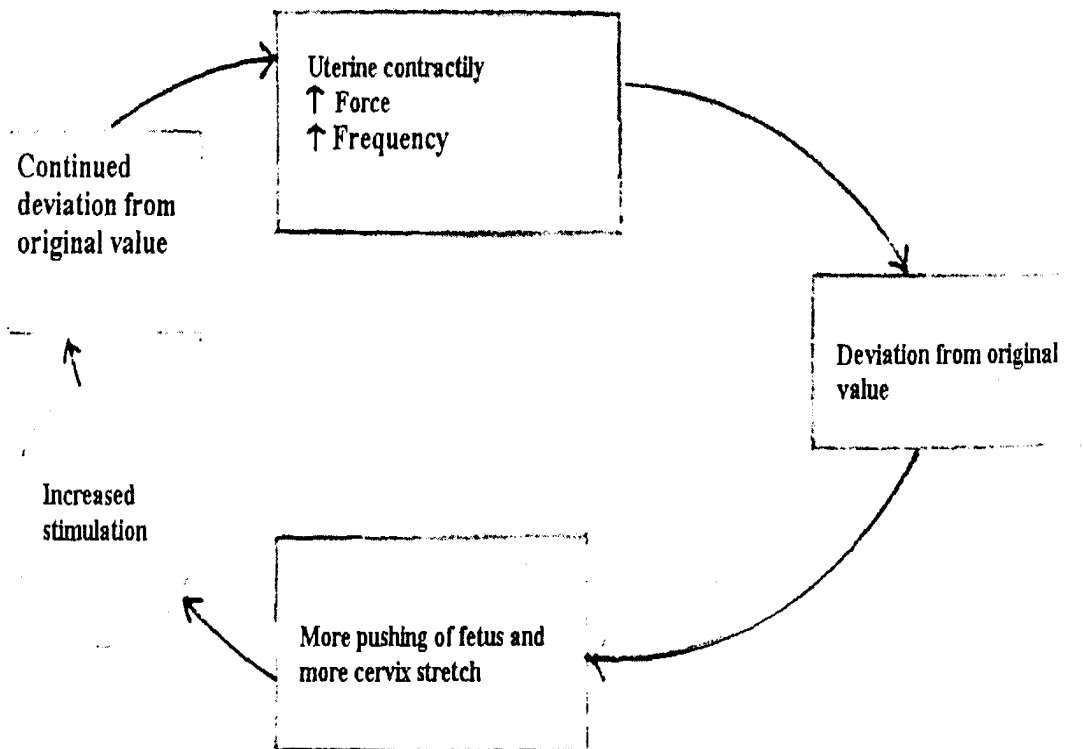
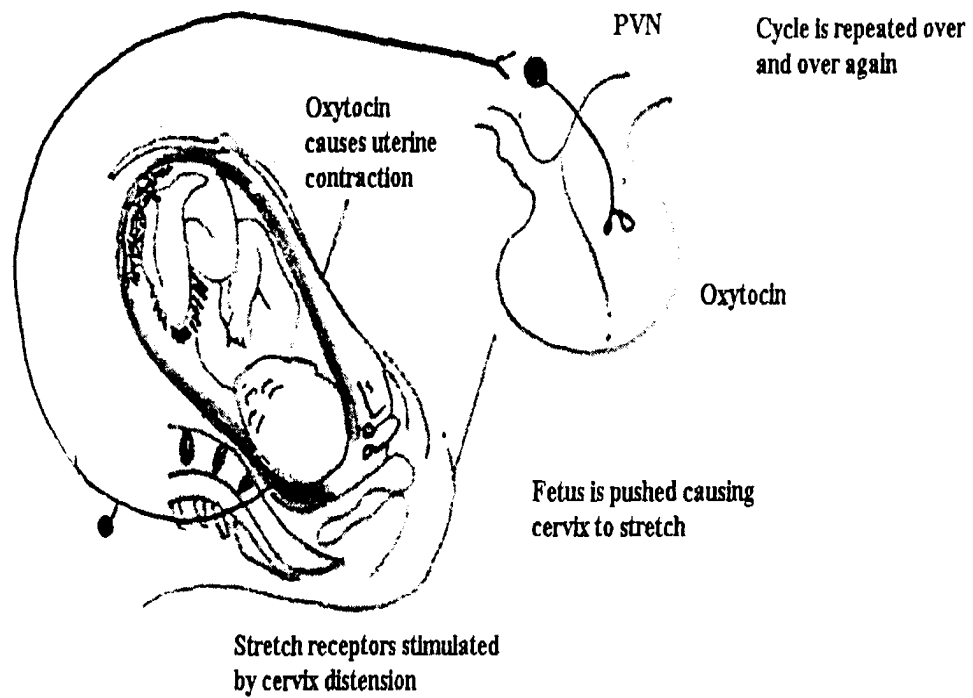

Figure 18. shows positive feedback control of the process of parturition.

Levels of Physiological Regulation: Three Levels

- Regulation at the level of single cells - Intracellular regulation
- Local Regulation - Intrinsic Regulation or autoregulation
- Extrinsic Regulation - control by hormones and/or nerves

Intracellular Regulation

It almost always means changes in the rates of enzyme-catalytic reaction. One set of enzyme serves a synthetic path, while the other serves a degradable pathway. This kind of regulation affects the balance between net synthetic and degradation within cells, and the relative flow through the two branches is controlled by both substrate and end-products levels. Sometimes intracellular control involves inhibition or stimulation of messenger –RNA synthesis or translation of m-RNA into protein. This regulates the synthesis of specific proteins - structural proteins and enzymes.

Control by Local Chemical Factors

Metabolic auto-regulation of blood flow: Increased blood flow in a vascular bed in response to increased metabolic activity by release of a number of vasoactive vasodilator substances - local factors that increase in blood flow - increased potassium, prostaglandins, increased carbon dioxide tension, lactic acid, bradykinin, osmolality and temperature increase. The negative feedback loop is closed when the increased blood flow increases oxygen/nutrient delivery to the active tissue and increase the rate at which the local vasodilator factors are flushed out. For any steady level of tissue activity, there is a corresponding set point for blood flow autoregulation. In this the error signal are carbon dioxide (a metabolic product) and the effector is the arteriolar smooth muscles.

Prostaglandins

Prostaglandins produced from arachidonic acid are implicated in many local regulatory functions, including inflammation and blood clotting, ovulation, menstruation, labor and secretion of gastric acid.

Intrinsic Autoregulation

The contractile elements of striated cardiac muscles have actin and myosin filaments, which on stretch of the cardiac cell increase the strength of contraction while excessive stretch decreases the strength of contraction. This is an example of intrinsic homeostasis. In almost all cases, intrinsic regulation is supplemented by extrinsic homeostatic processes via hormones and nerves or both.

Extrinsic Regulation: Reflex Category

Reflex arc or loops are circuits that link a detection system to a response system.

A reflex must have:

- An afferent, or sensory component that detects variation in external or internal variables, and relays information about the variable using neural or chemical signals.
- An integrator/integrating center: a collection of association neurons when present in the central nervous system, that determines the magnitude of the response that is appropriate; and
- An efferent, or motor component that sends neural or hormonal signals from the integrator to the effector organs (muscle, nerve, or glandular tissue)

These reflexes provide negative feedback, such as baroreceptor reflex (blood pressure), chemoreceptor reflex (oxygen, carbondioxide), vago-vagal reflex (excitatory or inhibitory: secretions and motility in the digestive system).

Neural and Endocrine Reflexes: In some reflex loop, nerves synthesize and release a substance that acts as hormone. These are neurosecretory or neuroendocrine cells. Endocrines are a line of communication between the nervous system and effector if their hormonal secretion are controlled by nervous inputs. In some cases, endocrine gland combines the function of sensor and integrator and respond to changes in the controlled variable by increasing or decreasing their rate of secretion - such a loop is hormonal/ endocrine reflex.

Reflexes are divided into three classes

- 1 Somatic motor reflex, that control skeletal muscle, e.g. withdrawal reflex
2. Autonomic reflexes that modulates the activity of smooth muscle exocrine glands, and the heart muscle
3. Endocrine Reflex in which the feedback loop may or may not involve the nervous system

Somatic Motor Control by Reflexes

- Somatic motor reflexes preserve constancy of body position with respect to the surrounding
- Protect the body from dangerous stimuli
- Voluntary movement of the body have enough reflexive components afferent input to the CNS reaches the spinal cord by way of nerve fibers from special sensor, organs, muscle, and joints. Skeletal muscles are controlled by efferent motor neurons. The pathway of information from sensory nerve to motor nerve, almost always contains interneurons (IN); they make specific connections that determines the reflex responses. These connections are established during development, so that sensory information results in effectors that make an appropriate response. This increases the possibilities for precise control and modification of the response.

Stretch reflexes are important in the maintenance of posture because their negative feedback loop tends to return limbs to their original position. Interneurons in the spinal cord connect the motor neuron of antagonist in such a way that activation of a muscle is automatically accompanied by deactivation of its antagonists.

Autonomic Reflexes

Sensory nerve signals are evaluated by integrating center within the CNS. Commands are sent out over efferent neurons and may stimulate or relax vascular smooth muscle, cause glandular secretion or alter intracellular metabolism. These nerve signals correct deviations from the set points programmed within the CNS. The visceral and somatic

reflexes have only anatomical differences in the pathways between the CNS, visceral and somatic system.

Endocrine Reflexes: Hormones as Chemical Messengers

Hormones are the major types of chemical messengers in the body. There are two important aspects about the mechanism of hormonal information transfer.

- Although the chemical messenger travels throughout the body, it is only received by target cells. Hormone binds with the receptor - this complex causes changes in the specific activities of the target cell.
- The response of the target cell to the hormone depends on the capabilities of that target cell. Same hormone may increase secretion in one cell and cause contraction of the smooth muscle.

CELLULAR ADAPTATION

Cells may adapt by undergoing change in size, number, and type to alterations in internal environment. Cells face insult by either dying or complete recovery. Between these two extremes there is a range of cellular responses where the cell adapts to insult. These reactions include atrophy, hypoplasia, hypertrophy, hyperplasia, metaplasia, dysplasia and the accumulation within the cell of a variety of materials that may be endogenous (lipofuscin) or exogenous in origin. Normal adaptive changes occur in response to need and appropriateness. Atrophy presents as: loss of cell substance, shrinkage in cell size, cells have lowered functional ability, decrease in the number and size of its organelles, decrease in cell volume, and loss of more specific functions.

Hypertrophy

Stimulation of the parenchymal cells of an organ by increasing functional demand or by hormones, result in an increase in the total mass of the cells. This may be by hypertrophy such as in skeletal muscle or by an increase in number - hyperplasia. In most organs both contribute to growth. It is usually more common in cardiac and

skeletal muscle as in athletes and laborers in which individual muscle fibers increase in thickness and not in number.

Effects of Endurance Training: Aerobic Training

- Increase in the size and number of mitochondria
- Increase in capillary / muscle ratio
- Increase in capacity to oxidize fat
- Increase in level of myoglobin
- The cardiovascular effects are:- increase in cardiac muscle mass and contractility; increased cardiac output at a lower heart rate; increased capillary in the myocardium; decreased peripheral resistance at rest
- In skeletal muscle, hypertrophy by increase in microfilaments, increase in cell enzymes and ATP synthesis; hypertrophy is influenced by blood flow
- There is increase in oxygen delivery and increase in oxidative capacity of skeletal muscle

Effects of Training on organs and organ system

- Oxygen transporting system: improves endurance for work; large heart volume, increased weight, enhanced vascularization of the heart muscle, increased capillary density, slow resting heart rate, increased centrogenic vagal cholinergic discharge/ drive, stroke volume increase, increased cardiac out put, increased arterio-venous oxygen difference increased at maximal work, increased maximal oxygen uptake
- Locomotion organs: increase in strength of bones and ligaments, thickness of articular cartilage and muscle mass; increased muscle strength, myoglobin, increased capillary density in muscle, and arterial collaterals
- Body density increases, serum cholesterol can decrease

Acclimatization to reduced oxygen pressure in the inspired air

- All adaptive changes are reversible
- As the oxygen content of blood increase, the maximal cardiac output apparently reduces

- Increase in ventilation is by hypoxic drive via peripheral chemoreceptors; greater diffusing capacity; a greater alveolar area and an increased capillary volume would facilitate gas diffusion in the lungs; increase in pulmonary ventilation followed by significant reduction in ventilation; gradual adaptation to chemoreceptor.
- Morphological and functional changes in the tissue: increased capillarization, increased myoglobin content, modifiers enzyme activity, increase in mitochondria, increase in tissue content of cytochrome oxidase,
- Alkalosis is gradually compensated in an acclimatized person
- Other changes include: increased erythropoietin production; increased hemoglobin concentration; increase in the 2,3 - DPG levels enhancing the unloading of oxygen to the tissues; increased hematocrit (in 7 days); increased viscosity 2-7 days; hemoglobin above 19 g/dl

The net effect of acclimatization to high altitude: gradual improvement in the physical performance in endurance events or prolonged work. An increased oxygen availability to the working muscles

Physiological Atrophy

Physiologic atrophy is a normal phenomenon of aging in many tissues such as involution of thymus gland after adolescence, the reduction in endometrial cellularity after the menopause. Lack of hormonal stimulation causes the atrophic changes in the ovary, uterus, vagina, and fallopian tubes during menopause. Prostate, seminal vesicles, and bulbo-urethral glands and the brain commonly atrophy in old age. In atrophy there is accumulation of Lipofuscin, a yellowish brown pigment inside the cytosol.

Endocrine Atrophy

In damage to the anterior pituitary gland there is diminution of the trophic hormone resulting in involution and atrophy of adrenal cortex and gonads. In endocrine hypofunction there may be significant atrophy of the hormone- dependent tissues e.g., the skin, hair follicles and sebaceous glands in hypothyroidism.

Neuropathic Atrophy

A denervated muscle undergoes atrophy when there is any destruction of somatic nerve (lower motor neuron) or their axon. After denervation, the muscle may lose half of their mass. Though synthetic activity lasts for sometime at a normal rate but catabolism is greatly enhanced. The denervated muscle shows acetylcholine hypersensitivity, fasciculations, fibrillations and EMG recording and complete recovery is impossible.

Disuse Atrophy

In a muscle tissue, Cell size is related to work load. As the workload of a cell decreases, there is decline in oxygen consumption and protein synthesis and the cell conserves energy by decreasing the number and size of organelles. In general, reduced cell activity is associated with reduced catabolism, which in turn has a negative feedback. An anaphy is observed in the muscles of extremities that have been cast in plaster or weightlessness in case of astronauts. This leads to wasting of both muscles and bones; reversible with function recovery.

Nutritional Atrophy

General atrophy occurs in prolonged starvation. Emaciation of starvation is mainly due to excessive utilization of the subcutaneous fat, but there is also wasting of lean mass muscles and even some organs such as liver. The term 'cachexia' means the combination of muscle wasting, organ shrinking, anemia and weakness, and is found in severely sick patients in whom there is loss of appetite, general gastrointestinal dysfunction associated with terminal stage of malignant tumor. The metabolic events of starvation permit life to continue for months without calorie intake, depending on the prestarvation stage. The daily weight loss, can range from one pound to several pounds on the stage of starvation. Protein loss ensues, with substantial weight loss, the most easily recognized sign of starvation. The weight loss is caused by loss of lean body mass and fat tissue.

Biochemical changes that occur in starvation:

- glycogenolysis (hepatic) continues for about 16 hours

- hepatic gluconeogenesis takes place using amino acids (especially muscle protein, there is increased urea excretion)
- as brain and other tissues use ketone bodies, glucose need is reduced. Ketone bodies also reduce glucose use by muscles, gluconeogenesis, protein catabolism and urine concentration decreases
- glutamine is used by the kidney for gluconeogenesis
- Proteins are spared to permit maximal starvation; survival requires of at least $\frac{1}{2}$ of muscle proteins. Total body proteins is 9 -11 Kg; muscle protein is reduced - 20 g/day.

Other Types of Atrophies

Increased catabolism in prolonged fever or as result of severe trauma may cause skeletal muscle atrophy. Tumors and cysts of an organ may cause pressure atrophy due to interference with blood flow or function of the tissue, e.g., damage to the nasal fibers by pituitary adenoma resulting in bitemporal hemianopia. Irradiation atrophy is due to chromosomal damage, which interferes with mitosis.

Hypoplasia

Hypoplasia is a state of failure of the tissue to reach normal size during development. It can have various causes: achondroplasia, an inherited cause. The affected individuals have short limbs, trunk relatively normal length, the head large with bulging forehead and scooped out nose. In some type of dwarfism, the cause may be the reduced production of growth hormone as in Lorain type dwarfism in which growth hormone receptors are defective in some instances cell loss may be due to infection or poisoning. Maternal rubella infection in first trimester may damage the fetal heart and a variety of embryonic defects related to development arrest involving all germ layers. Delayed and disturbed organ genesis produces structural defects of eye, brain, heart, and large arteries.

Hyperplasia

Hyperplasia without hypertrophy is unusual and one of the few examples affects the red blood cells. In a hypoxic environment with low oxygen tension, there is compensatory hyperplasia of red cell precursors and an increased number of circulating red blood cells is an example of compensatory hyperplasia. Hyperplasia is usually found in tissues that have the capability for mitosis, such as epidermis. An example of physiological hyperplasia is the enlargement of the breast in pregnancy in response to hormonal stimulation of target; an abnormal hormonal stimulation of target cell; an abnormally thick endometrium with excessive estrogen; such endometrium may bleed frequently.

Metaplasia

Metaplasia implies a change of one cell type to another that allows the new cells to tolerate environmental stress. In metaplasia there is transformation of one type of differentiated tissue into another. It occurs in chronic irritation and inflammation and it is reversible. In heavy smokers the surface epithelium of the bronchi changes from normal ciliated pseudo stratified columnar epithelium to stratified squamous. In this example chronic irritation or injury results in adaptive changes in the surface epithelium to a type resistant to smoke.

STUDY QUESTIONS

1. What makes the internal environment, indicate some important variables, to be maintained within normal range?
2. What are the functions of cellular organelles? Rough and smooth ER and Golgi complex apparatus?
3. Describe the chemical nature of plasma membrane and its characteristics.
4. Discuss the modes of transport across the plasma membrane.
5. Explain the functions of membrane proteins.
6. What is the significance of physiological signaling?
7. How does the first chemical messenger induce cellular transduction?
8. Define dynamic state of homeostasis.
9. Discuss the features of homeostatic controls.

- open loop and closed loop system
- negative and positive feed back controls

10. Elaborate reflex mechanism

- autonomic reflex
- somatic reflex
- endocrine reflex

11. Discuss adaptation to: Exercise; Hypoxia

Suggested reading

1. Adolph EF. Origin of physiologic regulation
2. Jones RW. Principles of biological regulation: An introduction to feedback systems. New York: Academic Press, 1973.
3. Yamamoto WS and JB Brobeck. Eds. Physiological controls and regulations.

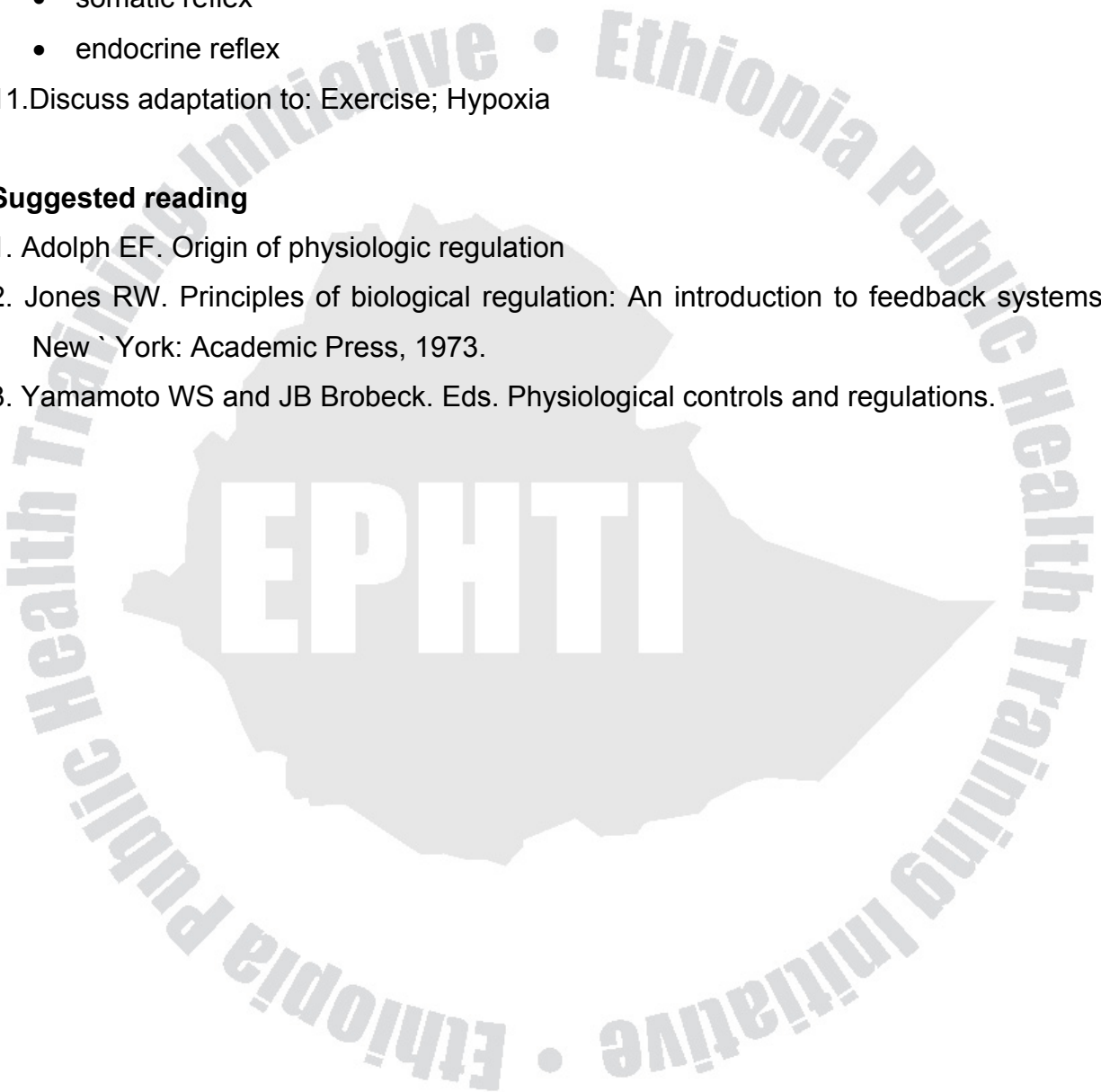

CHAPTER TWO

EXCITABLE TISSUES: NERVE AND MUSCLE

Learning Objectives

After completing this chapter, the student is expected to know the following:

- Understand the mechanisms nerve and muscle excitation
- Know how graded potentials and action potentials are induced
- Define action potentials
- Understand how neurotransmitter carry the signal across a synapse
- Know the composition of striated muscle, smooth and cardiac muscles
- Know the actions of Calcium in excitation contraction of muscle.
- Define the 2 types of muscle contractions: isotonic and isometric.

INTRODUCTION

All cells of the body possess a membrane potential related to the nonuniform distribution and varying permeability to Na^+ and K^+ and large intracellular anions. Nerve and muscle cells are excitable tissues developed a specialized use for the membrane potential. Nerve and muscle cells are capable of producing electrical signals when excited. Action potentials are brief reversals of membrane potential brought about by rapid changes in membrane permeability. Once started, action potentials are propagated throughout an excitable cell.

Membrane Potential

All plasma membranes are polarized electrically. It means separation of electric charges across the membrane, or to a difference in the relative number of cations and anions in the intracellular fluid and extracellular fluid. A separation of charges across the membrane is referred to as membrane potential. It is primarily due to differences in the distribution and membrane permeability of sodium, potassium and large intracellular anions. All living cells have a slightly excess of positive charges outside and a corresponding slight excess of negative charges on the inside of its membrane.

Table 3: Concentration and permeability of ions responsible for membrane potential in a resting nerve cell

Ion	Conc (mmol/L)	Conc (mmol/L)	Relative permeability
	Extracellular	Intracellular	
Sodium	150	15	1
Potassium	5	150	50-100
Anion (A ⁻)	0	65	0

Table 4: Concentration and electrical gradients

Ion	Condition	Gradient	Direction of Gradient
K ⁺	K	Concentration gradient	Outward
	(-90 mv)	Electrical gradient	Inward
Na ⁺	Na ⁺	Concentration gradient	Inward
	(+60 mv)	Electrical gradient	inward
K ⁺	Resting potential	Concentration gradient	Outward
	(-70 mv)	Electrical gradient	Inward
Na ⁺	Resting potential	Concentration gradient	Inward
	(-70 mv)	Electrical gradient	Inward

Effect of sodium-potassium pump on membrane potential

About 20% of membrane potential is contributed by the Na⁺ - K⁺ pump. This pump generates unequal transport for both positive ions, that creates a membrane potential with the outside becoming more positive than the inside. This active transport mechanism pumps three sodium ions out for two potassium ions pumped in. However,

most of the potential (80%) is caused by passive diffusion of potassium and sodium ions down their gradients.

Concurrent potassium and sodium effects on membrane potential

As potassium is more permeable at rest, it influences the resting membrane potential to a greater extent than does sodium. The resting membrane potential (RMP) of a typical nerve is -70 mV. It is slightly less than potassium equilibrium potential because of the weak influx of sodium. (See Figure 19). Nerve and muscle use the membrane potential for their specialized advantages. They are capable of rapidly and transiently alter the permeability of these ions in response to appropriate stimulation, thereby bringing about fluctuations in membrane potential.

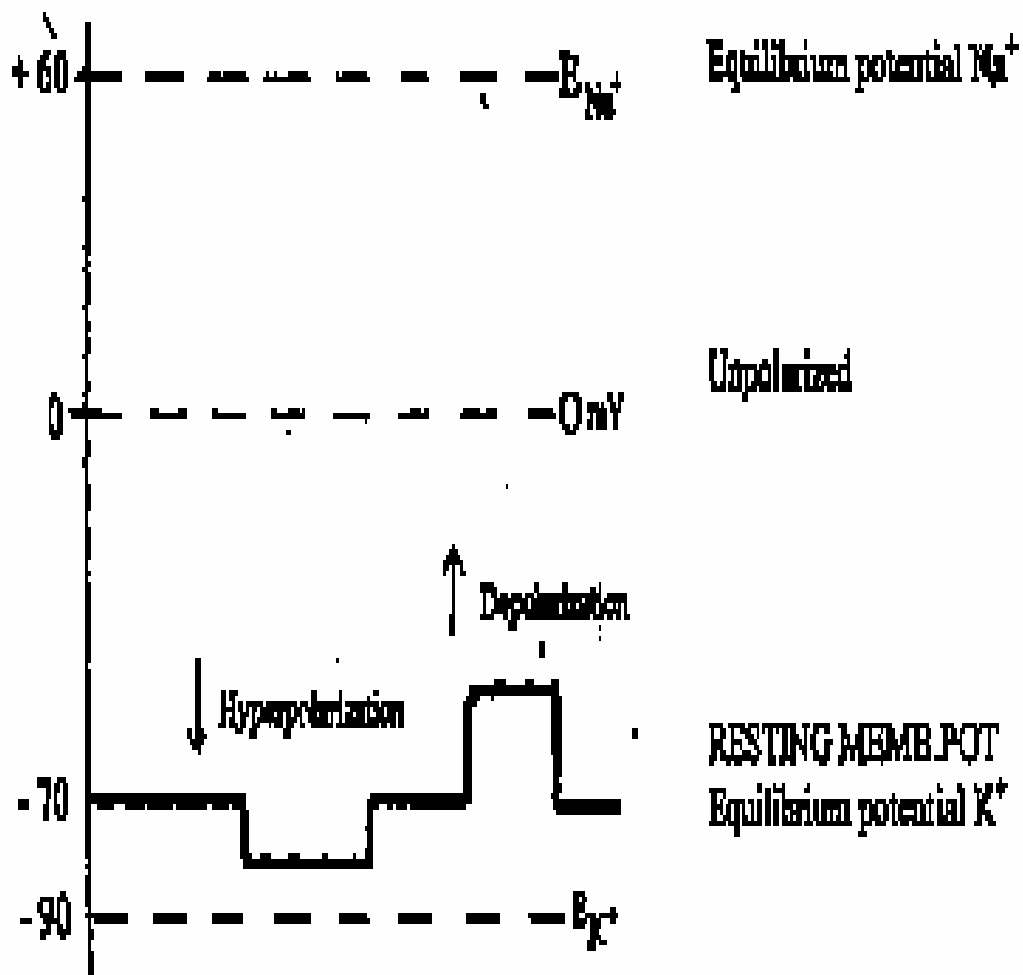
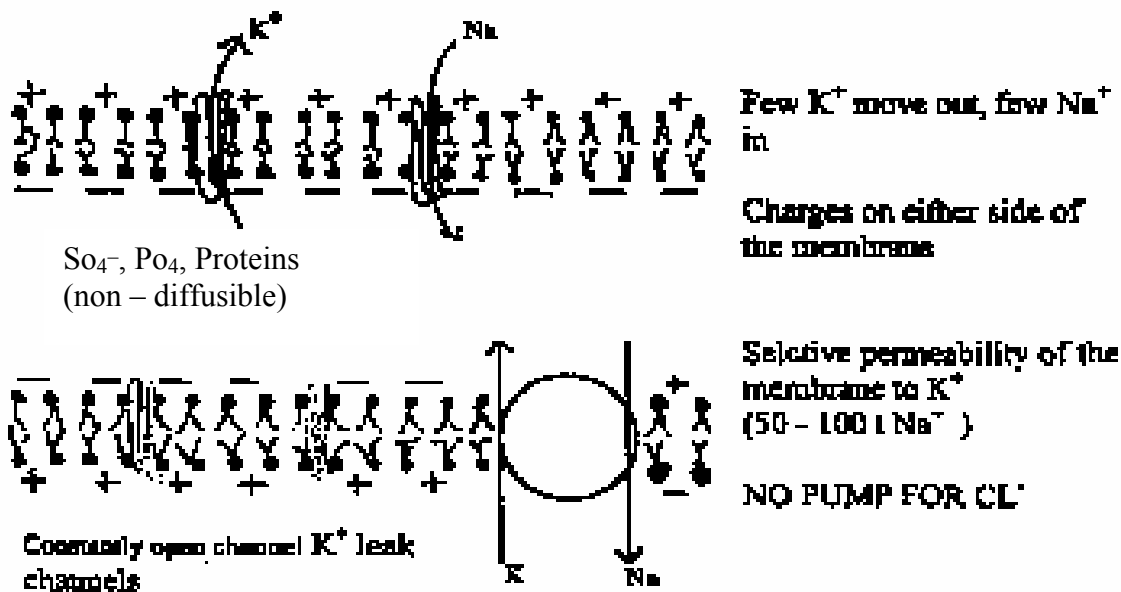

Figure 19. Shows resting membrane potential.



The membrane potential depends upon:

K⁺ Leak channels

K⁺ gradient across the membrane

Figure 20. Shows ionic bases of resting membrane potential.

NEURONS

The nervous system consists of cells that are called neurons varying enormously in size, and shape than any other cell. The neuronal cell contains a body and processes that are arranged to the cell to receive, conduct and transmit stimuli to other cells.

Glial cells: the neurons gain efficiency through special glial cells. These surround the neuron, adhering to their surface and helping to remove problem of resistance to the conduction of excitation.

Interneurons: Neural connections are established between the segment by means of interneurons. The interneurons may act as amplifier (excitatory) by enhancing or as attenuator (inhibitory) by putting a damper on an incoming signal or it may act as a polarity signal switch transforming a positive signal into negative one or vice versa.

Components of the nervous system

The cells typical of the nervous tissue are the neurons and glial cells.

Neurons: The original neuron is "nerve cell"- cells best equipped to sense and react to the chemical and physical change occurring in their surrounding environment. They are present in the entire human body and communicate with each other regarding their conditions and reactions. Primary neural functions include reception, conduction and transmission. To detect, conduct and transmit stimuli to another cell or cells. Nerve cells grow 2 types of processes from their cell bodies - axons and dendrites.

Dendrites: are those processes that are concerned with reception of stimuli from environment.

Axons: are those processes that are concerned with conduction and transmission of the stimuli-signal to another cell or cells. The axon gives out collateral branches when the target consists of many cells.

Glial cells or Neuroglial cells

The various functions of glial cells are:

- Mechanical supportive elements of neurons
- Insulator of neuron
- Phagocytic defense mechanism
- Secretory
- Modifiers of electrical activity in neuron
- Regulation of metabolism in neuron
- Development assistance in neuronal circuitry
- Producers of myelin sheath

Glial cells retain the ability to divide throughout life.

Endings or terminals in peripheral nervous system (PNS): Sensory endings

The sensory endings pick up a stimulus either directly from the environment as simple receptors or indirectly through specialized cells, as encapsulated receptors organs. A receptor is a biologic transducer which picks up one form of energy or stimulus and transforms it into another form of energy. All peripheral sensory endings are receptors either directly or indirectly.

Motor endings are neural endings that transmit impulses to the effector cells. Effectors are cells in organs that respond to impulses from the NS. Muscles and glands are effectors.

Classification of sensory endings or receptors:

1. **Exteroreceptors:** Localized in the body surface; receive information from the external environment

- Sight, hearing, smell
- Pick up distant stimuli (teleoreceptors)
- Touch, pressure, temperature
- Stimulation by contact

2. Propioreceptors

Localized in the locomotion apparatus (muscles, tendons, joints). Receive information regarding posture, movements

3. Interoreceptors (visceroreceptors)

Visceral activity (digestion, excretion, circulation)

Located in Viscera and blood vessels

Free nerve endings: Most free nerve endings arborize between the tissue cells; other surround the hair follicles.

Nerve fibers: The axons are covered by glial cells. Only the sites of synapses are free from the glial lining. The axons in the CNS are covered by glial cells and the PNS by Schwann cells. An axon with its glial covering is called nerve fiber. Depending on the presence or absence of myelin, the fibers are classified as myelinated or

nonmyelinated. The unmyelinated fibers in the CNS are covered by astrocytes. A certain relation exists between speed of the impulse and fiber caliber.

Table 5: Fiber diameter and speed of signal conduction.

Fiber type	Diameter (μm)	Cond. velocity (m/s)	Blocking agent	Functions
A α (I)	12-20	70-120	Pressure	Proprioception
A β (II)	5-12	30-70	Pressure	Touch, pressure
A γ	3-6	15-30	Pressure	Motor supply to muscle spindle
A δ (III)	2-5	12-30	Pressure	Pain, cold, touch
B	1-3	3-15	Hypoxia	Preganglionic autonomic
C (IV)	0.3-1.3	0.5-2.3	Local anesthetics	Pain, touch, pressure

Peripheral nerve: A bundle of fibers wrapped in a connective tissue sheath is a peripheral nerve. Within each bundle, between the fibers, collagen fibers and a few fibroblasts are situated. This is called endoneurium.

Electric signal in nerve: nerve cells or neurons make up the nervous system (NS), one of the control systems of the body. The nervous system controls body's muscular and glandular activities that are mostly directed towards maintaining homeostasis. Neurons act rapidly for electrical and chemical signaling for communication. Through chemical means neurons pass messages to muscles and glands through intricate pathways from neuron to neuron.

Electric signal: Nerve and muscle are excitable tissues. They are able to develop rapid and transient change in their membrane potentials. These fluctuations serve as signal /

impulse in 2 forms. 1. Graded potentials- serving as short distance signals, and 2. Action potentials- which serve as long distance signals without any change.

Graded potentials: Graded potentials die out over short distances. These are local membrane potentials. Changes occur in varying grades of magnitude or strength. For example, RMP of -70 mV may become -60 mV or -50 mV. This magnitude is related to the magnitude of the triggering event, i.e. the stronger the triggering event, the larger the graded potential.

The triggering event may be one of the following.

- Stimulus - such as light stimulating photoreceptors on the retina
- Interaction of chemical with a receptor on a nerve or muscle cell membrane (neurotransmitter).
- Spontaneous change of potential caused by imbalance in the leak-pump cycle.

Characteristics of Graded potential

- Graded potential change: magnitude varies with the magnitude of triggering event
- Decremental conduction: magnitude diminishes with distance from initial site
- Passive spread to nearby inactive areas of membrane
- No refractory period
- Can be summed (temporal and spatial)
- Can be depolarized or hyperpolarized
- Triggered by stimulus, by combination of neurotransmitter with receptor or by spontaneous shift in leak-pump cycle.
- Occurs in specialized regions of membrane designed to respond to triggering event: egs: end plate potential, receptor/ generator potential, excitatory postsynaptic potentials, inhibitory postsynaptic potentials

THE ACTION POTENTIAL

Characteristics:

- All or none membrane response, magnitude of the triggering event coded in frequency rather than amplitude of action potential
- Propagated through out membrane in undiminished fashion
- Self-generation in nearby inactive areas of membrane
- Refractory period present
- Summation impossible
- Always depolarization to threshold through spread of graded potential
- Occurs in regions of membrane with abundance of voltage-gated sodium channels

Initiation of the Action Potential

Action potential is generated when an axon is stimulated by sufficient strength electric current so that the membrane is suddenly depolarized from -80 to -60 mV, the critical drop initiating further change in potential. As soon as the critical level of depolarized, the threshold is reached, any further increase in the strength of the applied current do not affect size of the potential. It is all- or- none response. The action potential crosses the zero line it is moving from -80 to +30 mV inside the membrane. The action potential is propagated along the whole length of the fiber membrane with a constant speed and amplitude.

Monophasic and diphasic action potential.

When one electrode is kept inside and the other is outside, potential changes across the membrane can be measured and if properly amplified and electrodes connected to a cathode ray oscilloscope, they can be recorded as the monophasic action potentials. Using 2 surface electrodes on the nerve or muscle, a diphasic action potential can be seen on the screen and recorded (see figure 21)

Phases of the action potential:

- Resting membrane potential (RMP): Voltage difference between inside and outside of cell in absence of excitatory or inhibitory stimulation.
- Threshold potential: Membrane potential to which excitable membrane must be depolarized to incite an action potential
- Upstroke or rising phase: This is a very rapid period of change, when the cell is losing its negative resting potential, and becomes depolarized (zero potential) and shows reversal of the membrane potential so that the inside of the membrane is transiently positive.
- Overshoot: The short positive phase is known as overshoot and is usually of about +30 mV- +40 mV in amplitude.
- Repolarization phase: The down stroke of the potential change is the repolarization, a slower process than the initial phase of depolarization.

After potentials

- Depolarization after potentials: The membrane potential for a brief period becomes more positive than the resting membrane potential and the cell, therefore, is slightly more excitable than normal.
- Hyperpolarization after potentials: some cells reflect a fall in the membrane potential below the RMP for a brief period following the action potential. During this time, the cell is less excitable than normal.

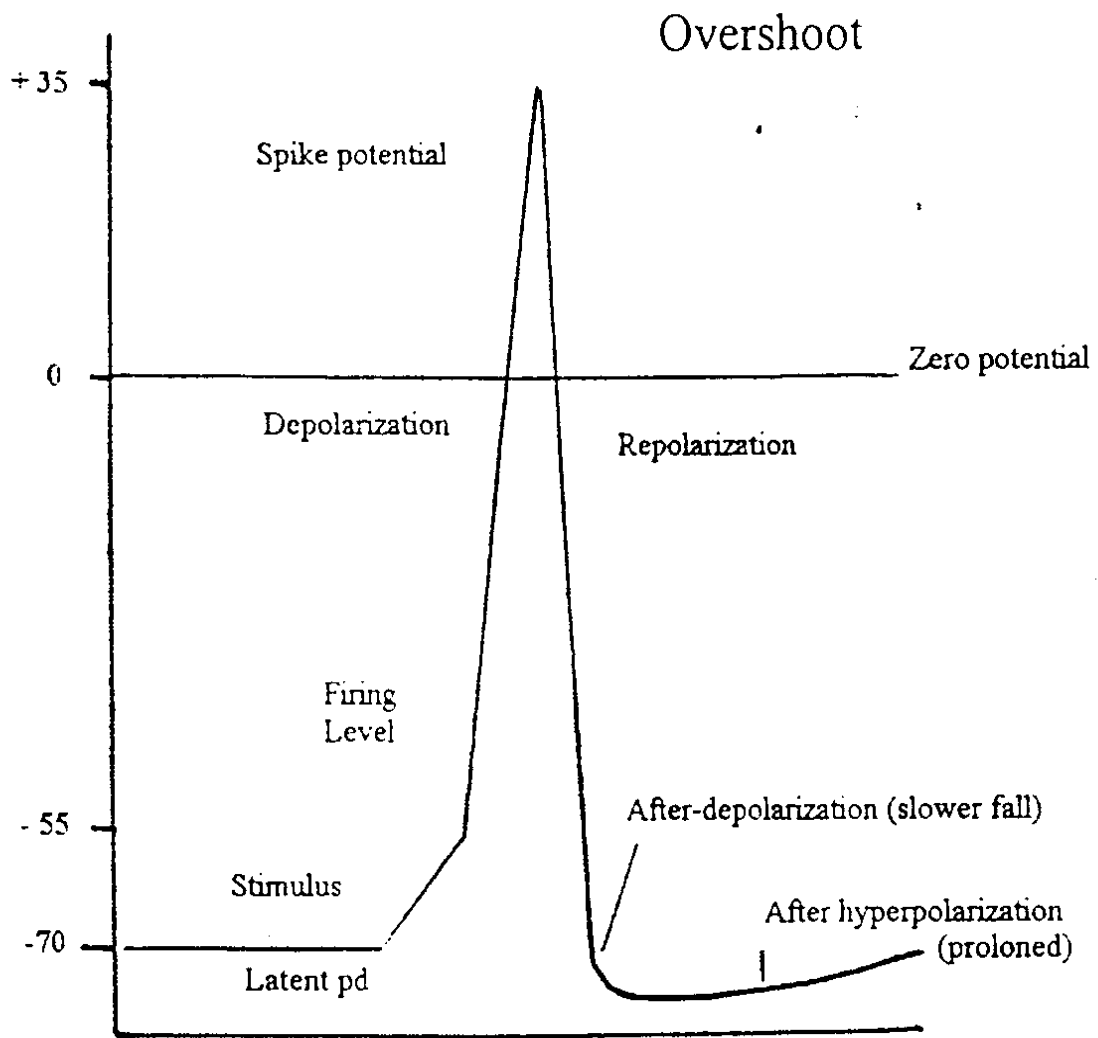

Figure 21. Shows phases of action potential.

Duration of the action potential

Though the peak of the action potential or the overshoot is about the same for most excitable cells, the duration of the action potential varies significantly. Action potentials for nerves are very brief, lasting only about 2-3 milliseconds, and the nerve cell is almost instantly ready again to conduct the next potential. Cardiac muscle cells, on the contrary, have long action potential more than 200 milliseconds, and these cells are not ready to respond to another stimulus until the cell membrane has almost returned to its original polarized state of RMP.

Ionic basis of the action potential

The different phases of the action potential are correlated with the following changes in ionic influxes: (See figure 22 & 23).

- The initial depolarization of the plasma membrane leads to an increase in the permeability of the membrane to sodium ions (sodium conductance)
- The sodium conductance rises very steeply by self-propagating (positive feedback) mechanism, because the more sodium enters, the greater the depolarization and the greater the increase in sodium conductance up to the peak of the impulse. This is the basis of the all or none character of the action potential. During this period the sodium channels are open.
- The potassium channels/gates open a little later than the sodium gates /channels and stay open for long. Consequently, the increase in potassium conductance / permeability starts a little later and lasts longer. The outward flow of the potassium ions slows the rise of the potential, then causes it to fall to its initial level by negative feedback mechanism, the membrane regains its original permeability and is ready to conduct another impulse.
- There is a very small period of less than 1 millisecond during which time the sodium gates are closing and the potassium gates are still open. During this time the nerve fiber is unresponsive to a depolarizing current and, therefore, cannot conduct an impulse. This is the absolute refractory period. This interval is very brief (2 millisecond) and the nerve fibers can carry very fast frequency of impulses. The absolute refractory period is followed by a recovery of excitability

during which time the threshold of the nerve is higher than normal, and so only stimuli of very great strength can evoke a propagated impulse, which is itself smaller and slower. This recovery phase is called relative refractory period. It lasts another 2 milliseconds after the end of the absolute refractory period.

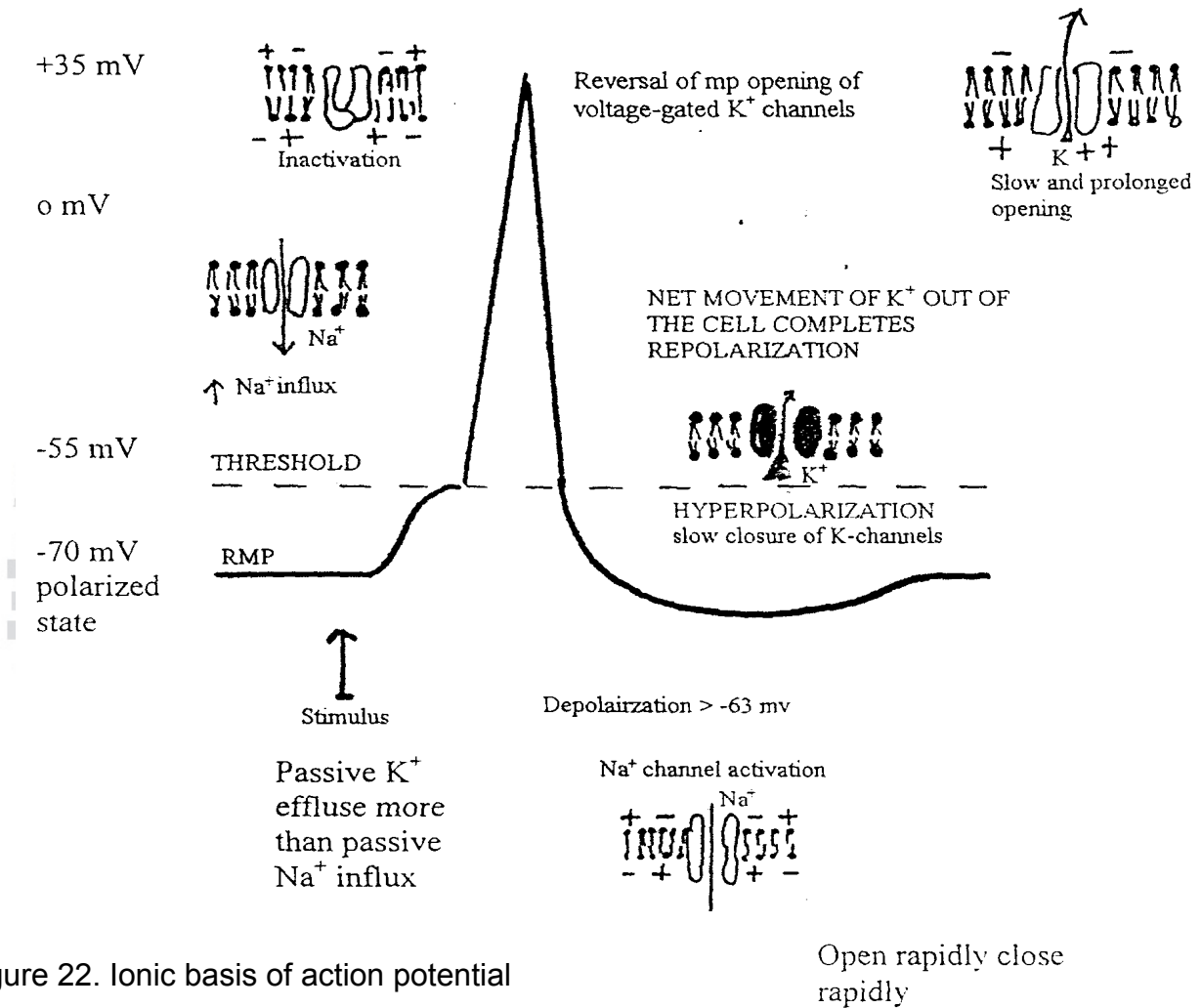

Figure 22. Ionic basis of action potential

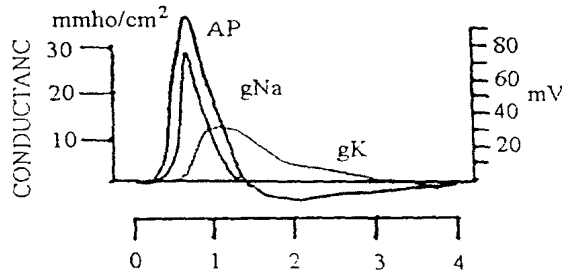

Figure 23. Changes in Na⁺ and K⁺ during action potential.

Conduction of the action potential

Cable conduction: Myelinated and unmyelinated nerves

The action potential is conducted along the nerve fibers by the ionic mechanism of the plasma membrane and also as though the fibers were conducting cables. There exists self regenerative sodium conductance of the stimulated membrane, which changes the initial depolarization to the all or none full-sized action potential that is propagated without loss of amplitude along the entire length of the fiber. Cable conductance is very slow in nerves that lack myelin sheath. Unmyelinated fibers are thin, slow conducting nerves often called "C" fibers on the basis of their diameter of less than 1 micron. Myelinated fibers have the nodes of Ranvier at regular intervals of 1-2 mm. Myelinated fibers are often classified as "A" fibers with diameters of 3-13 μm . The addition of myelin sheath allows an enormous increase in conduction velocity with a relatively small increase in fiber diameter.

Saltatory conduction

Inefficient electrical characteristic are compensated by the wrapping of the axon in concentric layers of myelin, which acts as insulating sheath that increases the resistance and greatly lowers the capacitance of the surface and by nodes of Ranvier at 1 mm distance that lifts the attenuated signals(see fig. 24)

Conduction depends on circular current flow

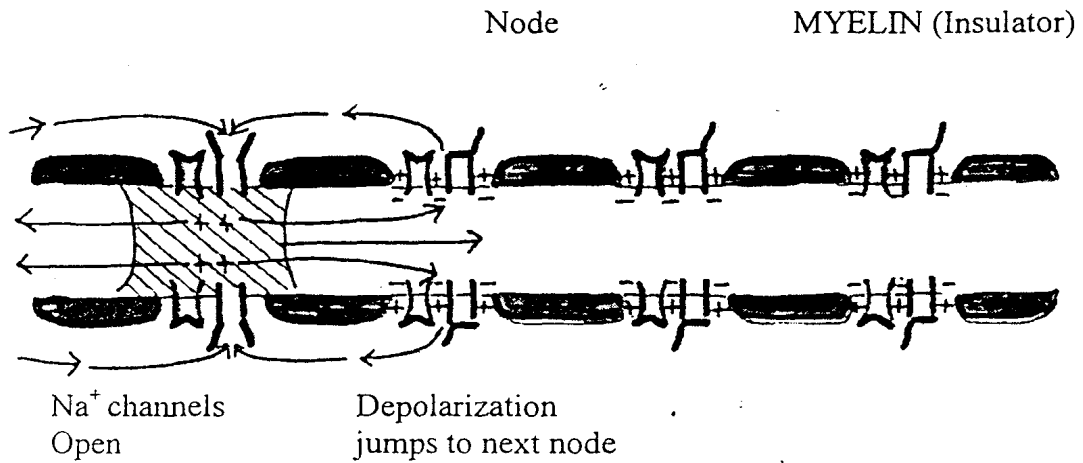

Spread of depolarization along the core of the axon and regeneration of signals at the nodes.

Depolarization jumps from one node to the next

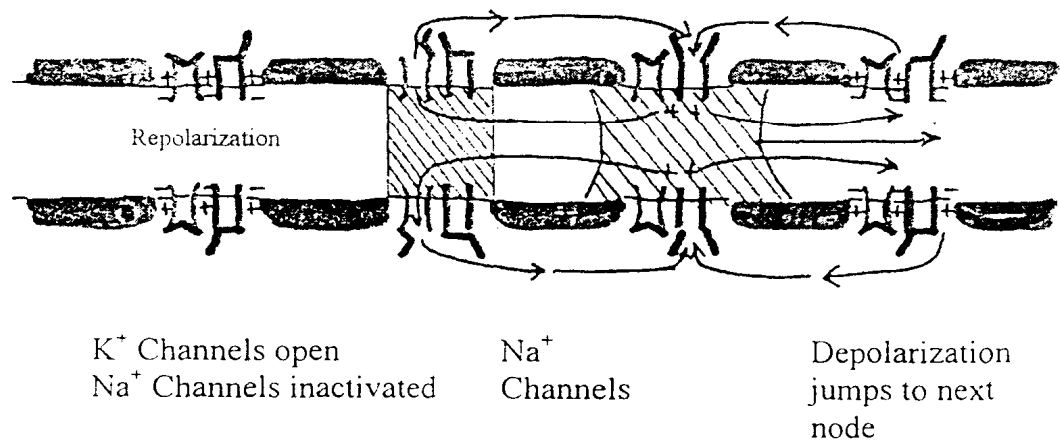
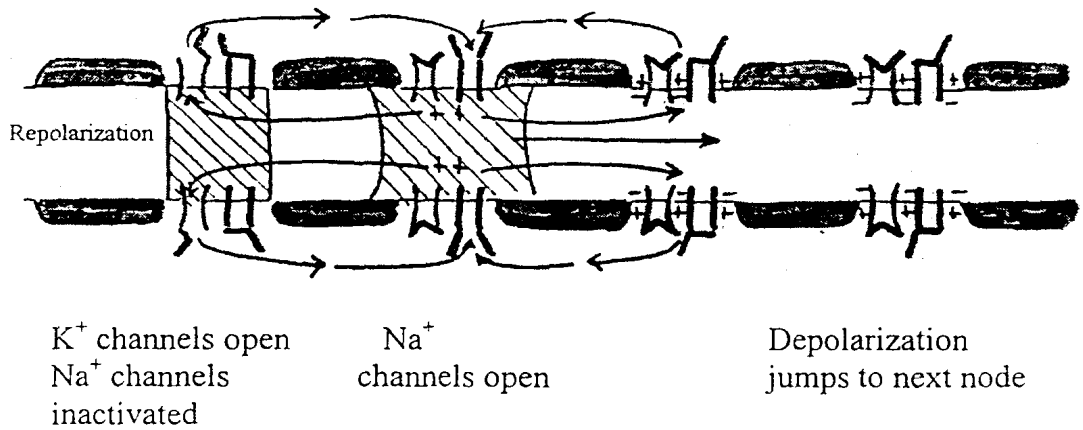

Figure 24. Shows propagation of Nerve impulse in myelinated nerve fibers

The stimulus

A stimulus is any change that can alter the energy state of a tissue sufficiently to depolarize the membrane. A nerve can be stimulated by mechanical, thermal, chemical, osmotic or electrical stimulation. These various stimuli are converted or transduced by the nerve to an electrical response, i.e. an action potential.

Excitability

Excitability may be defined as the ability of a cell to respond to a stimulus with an action potential.

Excitability and parameters of the stimulus

A stimulus must fulfill to evoke response. It involves the following parameters.

- Strength of the stimulus
- Duration of the stimulus
- Rate of rise of the stimulus intensity.

Neuromuscular junction / synapse

The neuromuscular junction is the specialized region of contact between nerve and muscle. Each skeletal muscle fiber receives only one of the many terminal branches of the nerve fiber. All movements are composites of contraction of muscle unit, the motor neuron, its axon, and all the muscle fibers it innervates. The resulting contraction of each muscle fiber of the motor unit is all –or- nothing. Increase in the strength of muscle contractions are obtained through the recruitment of greater number of motor units.

Motor unit: is the motor nerve and all the muscle(s) innervated by the nerve

Functional anatomy of neuromuscular Junction

Presynaptic Structure

The axon terminals in knobs on the membrane surface do not fuse with it. The knob terminals have the spherical synaptic vesicles (40-200 nm diam.) containing acetylcholine, and the many mitochondria needed for synthetic processes occurring in the terminals. There are active zones of the presynaptic membrane, where transmitter

release occurs. The presynaptic membranes have selective ionic gates, voltage gated Ca^{++} channels

The synaptic Cleft: The cleft is a gap of about 40 nm separating the axon terminal and the muscle membrane.

Postsynaptic Structure

At the junction area, there is an enlargement of the sarcoplasm of the muscle fiber, known as the end plate. This is the postsynaptic region where depolarization occurs to give rise to the end-plate potential (EPP). The postsynaptic surface area is markedly increased by deep junctional folds.

The postsynaptic membrane is both structurally and physiologically different from the rest of the muscle membrane. The postsynaptic region responds only to chemical stimulation or inhibition. The region of the muscle surface membrane under the nerve terminal is sensitive to acetylcholine.

PHYSIOLOGY OF THE NEUROMUSCULAR JUNCTION

The EPP is graded in size and at a critical level of depolarization- about 50 mV-it triggers an impulse that travels along the muscle membrane. (See figure 24 & 25).

MECHANISM OF ACTION OF ACETYLCHOLINE

Release: The action potential reaching the nerve terminal depolarizes the membrane to about 30 mV to open the calcium channels permitting the influx of ionic calcium down the steep electrochemical gradient. This triggers the release of Ach from the synaptic vesicles by exogenous Ca^{++} .

Recycling of vesicles: The disrupted vesicles are modified and same vesicles are pinched off and filled. These vesicles store Ach.

Ach activity of the end plate

At the motor end plate, Ach combines with a muscle receptor that results in opening of the ionic gates to cause depolarization, and also it combines with a hydrolytic enzyme - Ach esterase (AChE) which rapidly inactivates it, after its role is over. The Ach receptor is a protein; its conformation changes when Ach binds to it, resulting in the opening of the ionic gates and a change in permeability. Curare also binds to receptor protein but alters it to an inactive form, which does not result in depolarization. Snake venom containing bungarotoxin binds very tightly and specifically to Ach receptor. The receptor density is very high (3×10^7) per end plate, which is enough for the 10^4 quanta of Ach released. There are 12,000 -21,000 molecules of Ach per quanta packed in to one vesicle.

Inactivation of acetylcholine

The concentration of Ach at the end plate remains high briefly for it is hydrolyzed rapidly by the enzyme AChE into choline and acetate.

Synapse and neuronal integration

A neurotransmitter transmits the signal across a synapse. A neuron terminal ends at a muscle, gland or another neuron. The junction between the 2 neurons is a synapse. Classically, a neuron to neuron synapse is a junction between an axon terminal of one neuron and the dendrites or cell body of a second neuron. Some neurons within the CNS receive as many as 100,000 synaptic inputs.

Inhibitory and excitatory synapses

Some synapses excite the post synaptic neuron whereas others inhibit it, so there are 2 types of synapses depending on the permeability changes in the post synaptic neuron by the binding of neurotransmitter with receptor site. At an excitatory synapse, the neurotransmitter receptor combination opens sodium and potassium channels within the subsynaptic membrane, increasing permeability to both ions. Both ions move simultaneously in opposite directions as per their gradients.

A nerve impulse stimulates a muscle cell...all within a few milliseconds

RESTING
NEUROMUSCULAR
JUNCTION

Voltage - gated Ca^{++}
channel

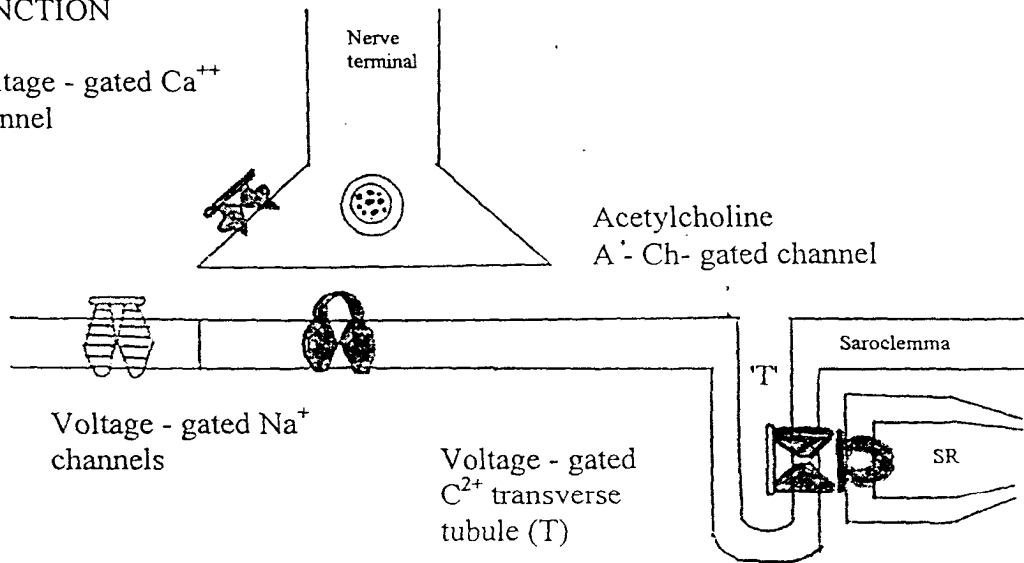

Acetylcholine
A⁺-Ch- gated channel

Voltage - gated Na^+
channels

Voltage - gated
 Ca^{2+} transverse
tubule (T)

Sarcolemma

SR

ACTIVATED NEUROMUSCULAR JUNCTION

Outside Ca^{2+}
concentration is >
1000 times

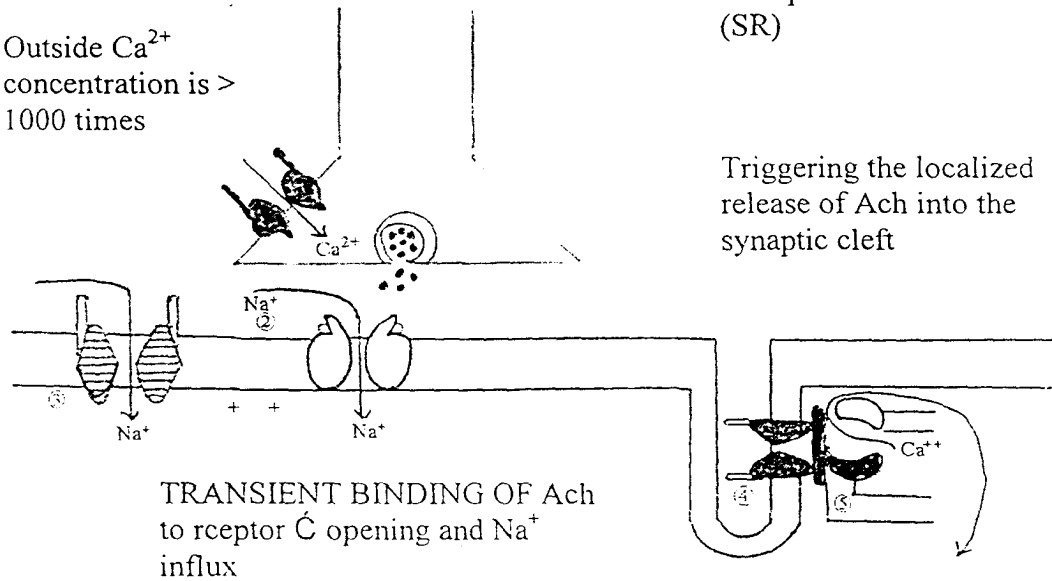

Ca^{2+} release channel in
sarcoplasmic reticulum
(SR)

Triggering the localized
release of Ach into the
synaptic cleft

TRANSIENT BINDING OF Ach
to receptor C opening and Na^+
influx

Transient opening
of Ca^{2+} release
channel.

Local depolarization opens Na^+
voltage - gated channel \rightarrow more
depolarization \rightarrow opens neighboring channels \rightarrow
self-propagated AP

Figure 25. Shows neurotransmission at neuromuscular junction.

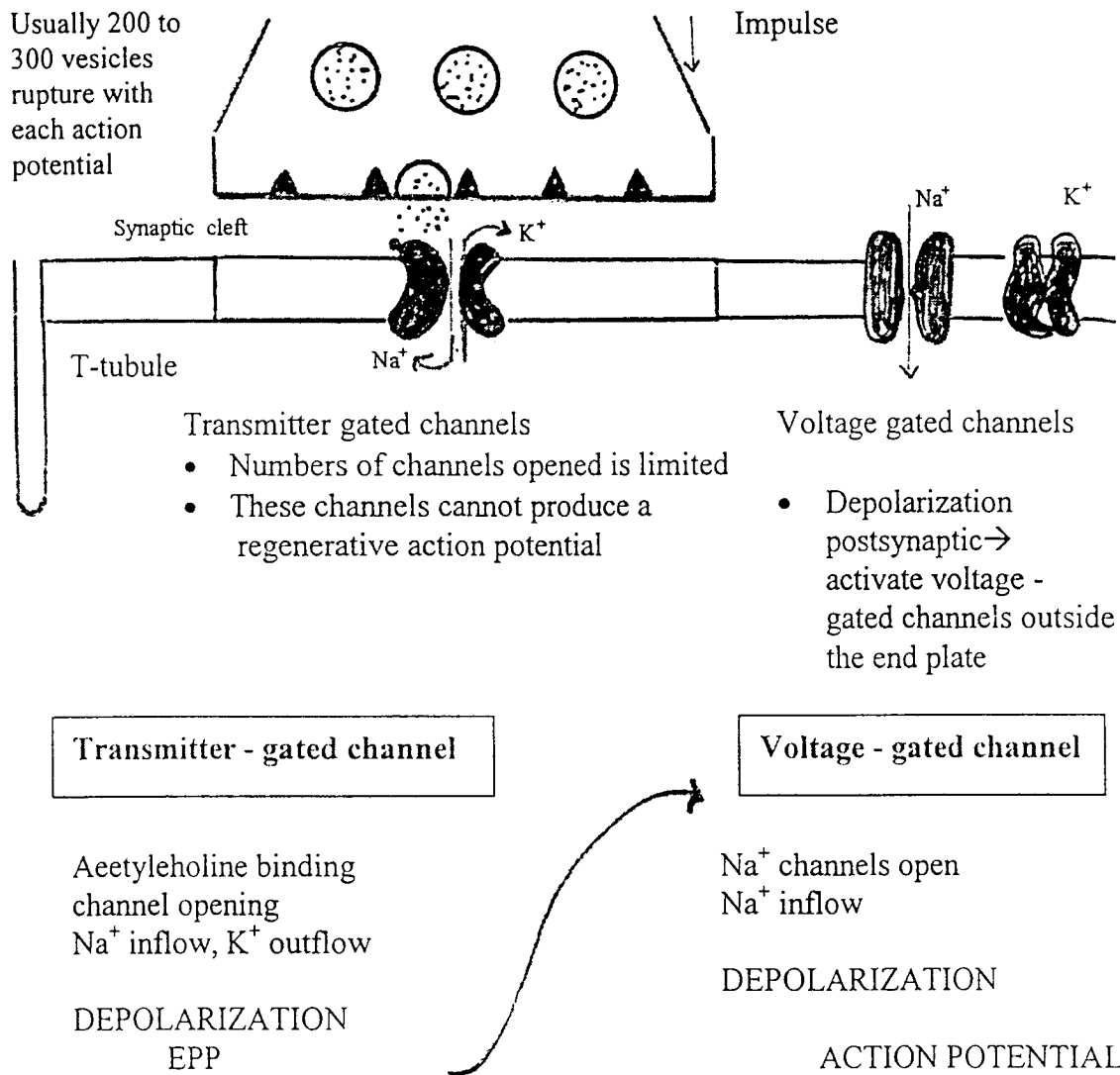

Figure 26. Shows generation of endplate potential

CHEMICAL NEUROTRANSMITTER (small, rapidly acting molecules)

Acetylcholine (Ach), dopamine, epinephrine, norepinephrine, serotonin, histamine, glycine, glutamate, aspartate, gamma-aminobutyric acid:

Neuropeptides (large, slow-acting molecules)

Beta-endorphin, ACTH, MSH, TRH, GnRH, somatostatin, VIP, CCK, gastrin, substance P, neurotensin, leucine, enkephalin, methionine enkephalin, motilin, insulin, glucagons, angiotensin-II, bradykinin, vasopressin, oxytocin, carnosine, bombesin.

Removal of neurotransmitter

It is important that neurotransmitter be inactivated or removed after it has produced desired response in the postsynaptic neuron, leaving it ready to receive additional message from the same or other neuron inputs. The neurotransmitter may diffuse away from the cleft, be inactivated by specific enzyme within the subsynaptic membrane, or be actively taken back up in to the axon terminal by transport mechanism in the presynaptic neuron for storage and release at another time.

Characteristics of chemical transmission

- Chemical transmission is unidirectional
- Chemical transmission is graded, with the amount of transmission chemical released dependent on the frequency of stimulation of the presynaptic neuron.
- The effect of chemical transmitter can be summed so that the final state of the postsynaptic potential will depend on the amount of excitatory transmitter reaching the postsynaptic membrane.(temporal and spatial summation)
- There is delay at the synapse
- There are means of inactivating the transmitter by enzyme.
- There has to be rapid, efficient means of synthesizing the NT at the nerve terminals.
- Chemical transmission is variable, susceptible to change in physiological conditions such as fatigue and disease

SKELETAL MUSCLE

Body's skeletal muscles play a major role in producing food, breathing, heat generation for maintenance of body temperature and diverse movements including movement away from harm; thus, this contribute to homeostasis by their versatile movements.

Skeletal muscles attached to the bones contract allowing the body to perform a variety of motor activities; these activities are needed for acquisition, chewing and swallowing of food, and that move the chest for breathing. They also contract in defending the body by protective movements. Smooth muscles are present in all hollow organs and the vascular conduits. Regulated contractions of smooth muscles make the blood flow through the vessels, food through the GIT, air through the respiratory passages, and urine to the out side. Cardiac muscle pumps life sustaining blood throughout the body.

The muscle cells are the real specialists having contractile proteins present in skeletal, cardiac and smooth muscle cells. They are capable of shortening and developing tension that enables them to produce movement and do work. Muscles in response to electric signals convert chemical energy (ATP) into mechanical energy that helps in purpose movement of the body: driving a car or moving a piece of furniture.

Skeletal muscle is the largest body tissue accounting for almost 40% of the body weight in men and 32% in women. Smooth muscles and skeletal muscles account about 10% of the total weight. Muscles are categorized as striated and non-striated/ smooth muscles and also typed as voluntary and involuntary subject to innervations by somatic or autonomic nerves and whether subject to voluntary or not subject to voluntary control.

Microstructure of Skeletal muscle

Skeletal muscles contract in response to signals from its innervating somatic nerve that releases acetylcholine at its terminals that starts the muscle action potentials. A muscle fiber is fairly large, elongated and cylindrical shaped ranging from 10-100 μm in diameter and up to 2.5 feet in length. A muscle is made up of a number of muscle fibers arranged parallel to each other and wrapped by connective tissue as a bundle. A single muscle cell is multi-nucleated with abundant number of mitochondria to meet its high energy demands. Each cell has numerous contractile myofibrils, constituting about 80% of volume of muscle fibers extending the entire length. Each myofibril consists of the

thick myosin filaments (12-18 nm diameter) and thin actin filaments (1.6 nm in diameter).

A relaxed muscle shows alternating dark bands (A band) and light bands (I band) due to slight overlapping of thick and thin filaments under the microscope. H zone does not have the thin filaments. The "I" band contains only thin actin filaments. In the middle of each I band is a dense vertical Z line, actually a flattened disc like cytoskeletal protein that connects the thin actin filaments of 2 adjoining sarcomers. Relaxed sarcomer is about 2.5 μm in width. (See figure 27).

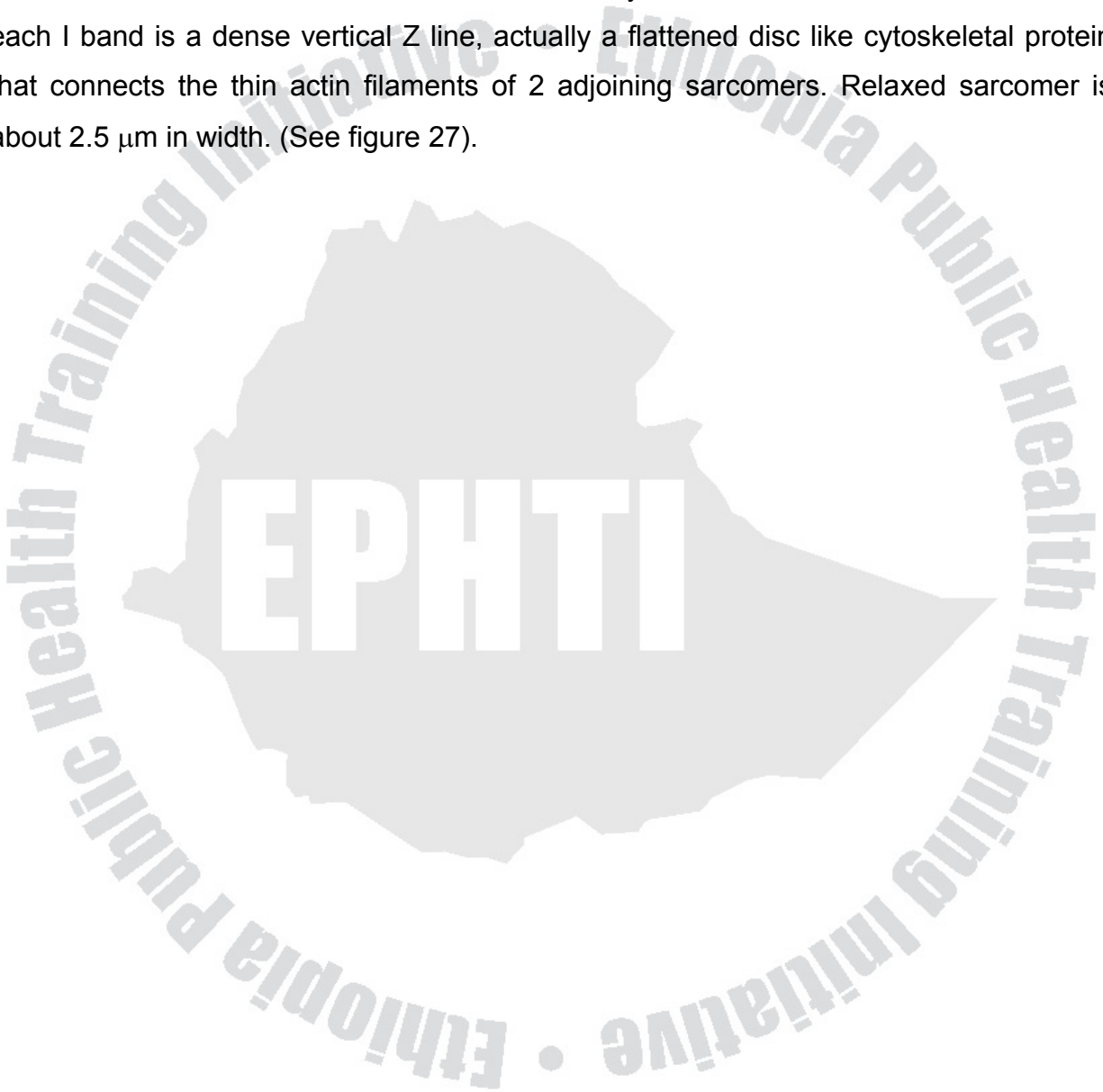

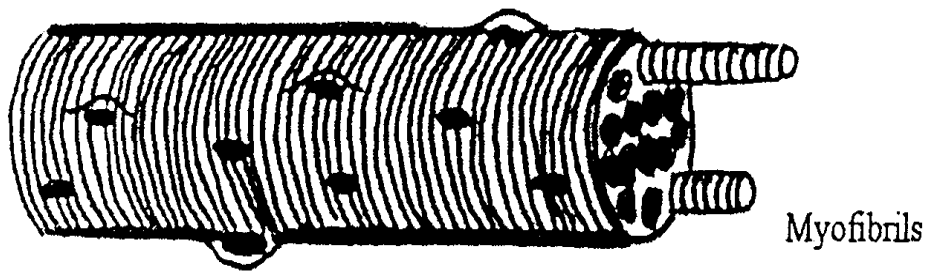

The bulk of the cytoplasm is made up of myofibrils'. which are the contractile elements of the muscle cell they are cylindrical 1-2 μm in diameter and often as long as the muscle itself

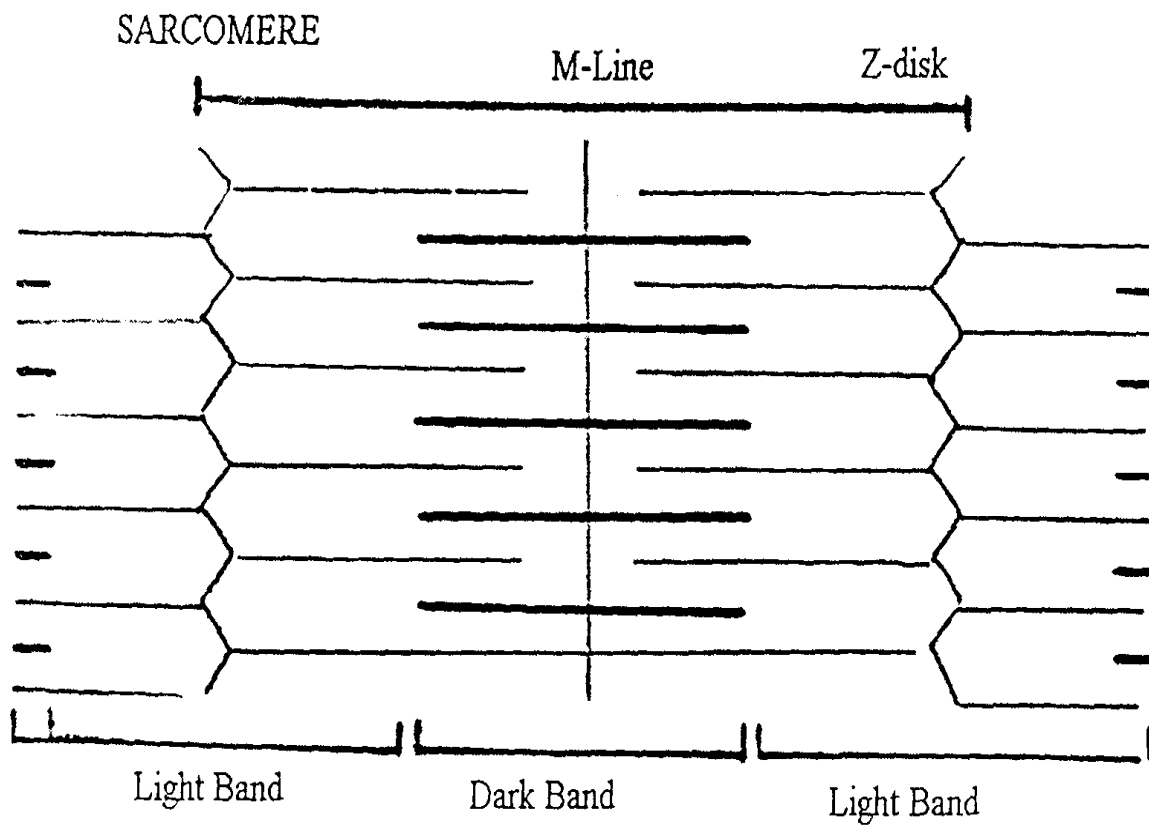

Figure 27. Structure of myofibrils

EXCITATION - CONTRACTION COUPLING

Calcium is the link between muscle excitation and contraction. Excitation - Contraction Coupling refers to the sequence of events linking muscle excitation to mechanical contraction. At neuro-muscular junction of skeletal muscle neurotransmitter Ach released from innervating motor neuron results in muscle contraction. The surface membrane dips in to the muscle fiber to form a 'transverse tubule' which runs from the cell membrane surface in to the central portion of the muscle fiber. The T- tubule also has receptors where it contracts the ryanodine receptors. These T- tubule receptors are known as dihydropyridine receptors. When an action potential travels down the T- tubules, the local depolarization activates the voltage-gated dihydropyridine receptors. Activated T- tubules receptors in turn trigger the opening of the Ca^{++} channels (ryanodine receptors) in the adjacent lateral sacs of the sarcoplasmic reticulum. Calcium is released from lateral sacs. Tropomyosin-troponin complex is repositioned; the released Ca^{++} binds with troponin C exposing the binding sites on the actin molecule so that they can attach with the myosin cross bridges at their specific sites. (See figure 28). A myosin cross bridge has an actin binding site and an ATPase site. In skeletal muscle, Mg^{++} must be attached to ATP before myosin ATPase can split the ATP yielding energy in the process. It is to be noted that fresh ATP must attach to myosin to permit the cross bridges link between myosin and actin to be broken down at the end of the cycle. The necessity for ATP for separation of myosin and actin is well evidenced by rigor mortis. This stiffness of death is a generalized locking in place of skeletal muscle beginning 3-4 hours after death and completed in about 12 hours.

A single action potential in skeletal muscle fiber lasts only 1-2 msec. The onset of the resultant contraction response lags behind the action potential because the excitation-contraction coupling process must occur before cross bridges activity begins. As a matter of fact, the action potential ends before the contraction mechanism even becomes operational. This time delay of a few msec between stimulation and onset of contraction is known as the 'latent period'. This is also needed for generating tension within the muscle fiber. The contraction time lasts about 50 msec, although it varies with

the type of muscle fiber. The relaxation time lasts slightly longer than contraction time, another 50 msec or more.

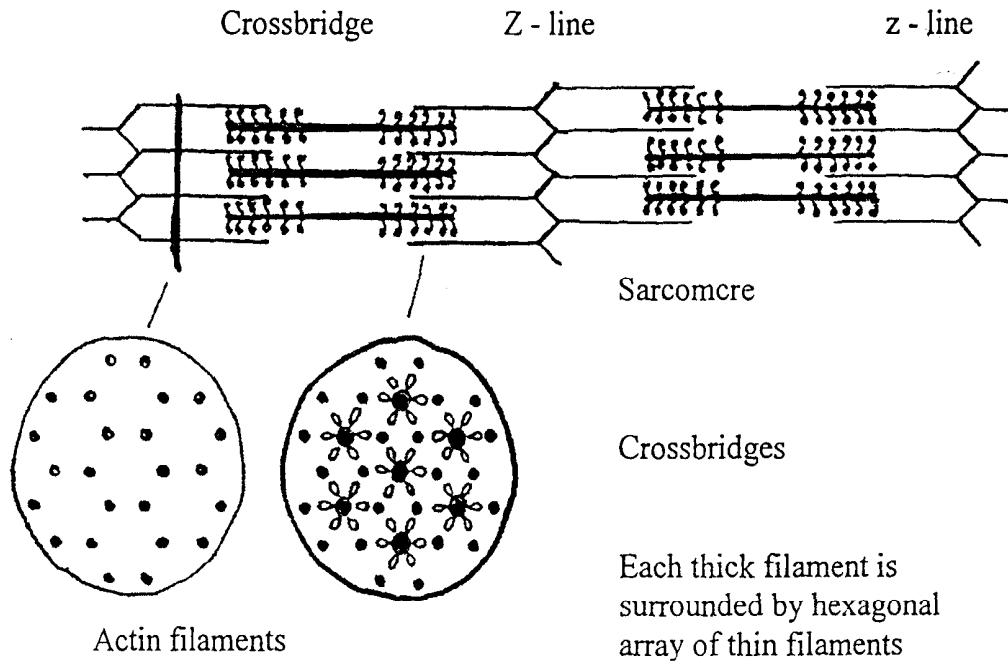
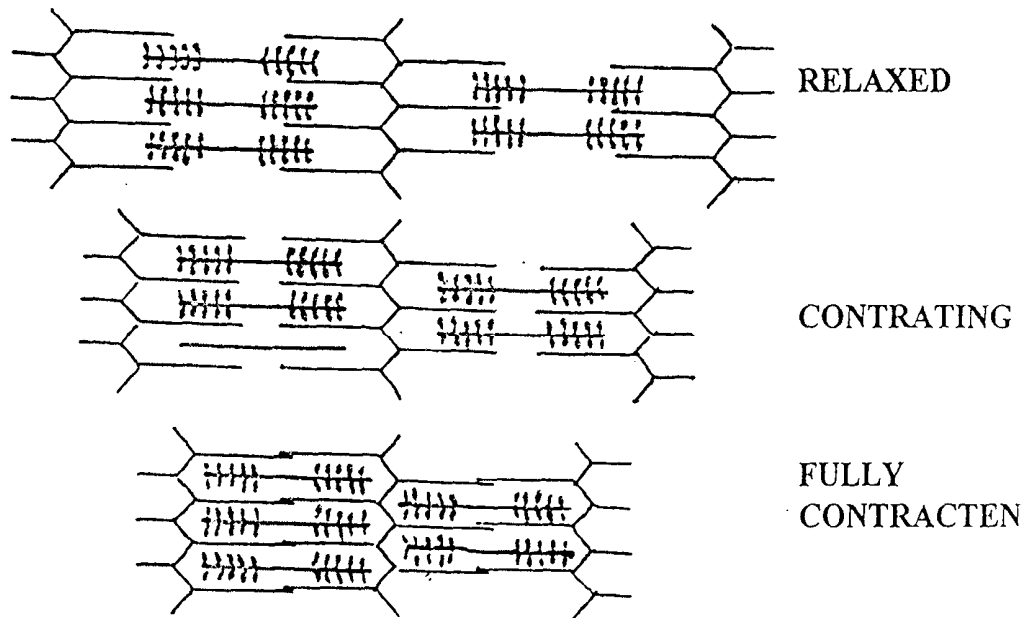

Figure 28. shows sarcomere shortening in response to crossbridge formation



Myasthenia gravis

Myasthenia gravis is an autoimmune disease. It occurs in about one of every 20,000 persons, causes the person to become paralyzed because of inability of the NMJ to transmit signals from the nerve fibers to the muscle fibers.

Clinical symptoms

- (a) Profound muscular weakness and rapid onset of fatigue.
- (b) Weakness of levator palpebrae superioris muscle (muscle of the upper eyelid) leads to drooping eyelids, which is the early prominent sign.
- (c) If the disease is intense enough, the patient dies of paralysis, in particular, of paralysis of the respiratory muscles.
- (d) In many cases, the thymus is enlarged

Etiology

Binding of antibodies to ACh-receptors

It is due to the failure of NMJ transmission which results from binding of antibodies to the ACh receptor on the post-synaptic membrane. This binding stimulates integration and degradation of the receptors. Therefore, there are fewer receptors available for binding with ACh. When an action potential depolarizes the presynaptic membrane, the transmitter cannot activate enough receptors to evoke an action potential in the muscle fiber. The sarcolemal depolarization is insufficient.

Autoimmune thymitis

Enlarged thymus may also be another cause of myasthenia gravis. Autoimmune thymitis associated with the release of a hormone called thymopoietin (or thymine). Thymopoietin is a polypeptide (MW=5562) which cause neuromuscular block in experimental animal.

Treatment

Anticholinesterase drugs

The disease can usually be ameliorated by administering anticholinesterase drugs like physostigmine, neostigmine. This allows far more ACh to accumulate in the NMJ. High concentration of ACh are able to displace antibodies from the ACh receptor-antibody complex and thereby overcome the neuromuscular block. Within minutes, some of these paralyzed persons can begin to function normally

Muscle twitch

Contraction of a whole muscle can be of varying strength. A twitch, which is too short and too weak for any use in the body, is produced as a result of a single action potential in a muscle fiber. Muscle fibers are arranged into a whole muscle and function with cooperation producing contraction of varying grades of strength stronger than a twitch.

Two factors accomplish gradation of whole muscle tension.

The number of muscle fibers contracting within a muscle

The tension developed by each contracting fiber.

Motor unit: Each whole muscle is innervated by a number of different motor neurons. One motor neuron innervates a number of muscle fibers, but each muscle fiber is supplied by only one motor neuron. On activation of a motor neuron, all of the supplied fibers are stimulated to contract simultaneously - the team of concurrently activated component is a 'motor unit'. For stronger contraction, motor units are recruited or stimulated to contract.

Muscles producing very precise, delicate movement such as extraocular eye muscles and the hand digit muscles contain a few dozen muscle fibers. These small motor units allow a very fine degree of control over muscle fibers. Muscles designed for powerful, coarsely controlled movement such as those of legs, a single motor unit may have 1500-2000 muscle fibers.

Isometric and Isotonic contraction

As a result of cross bridge activity and the resultant sliding of filaments, a tension is developed internally within the sarcomere. This tension generated by the contractile elements is transmitted to the bone via the connective tissue and tendon before the bone can be moved. Intracellular components of the muscle such as the elastic fiber proteins and connective tissue collagen fibers have a certain degree of passive elasticity. These non-contractile elements are the 'series-elastic-components' of the muscle, behaving like a spring placed between the tension generating contractile proteins and the bone that is to be moved against an external load. Shortening of the sarcomere stretches the 'series- elastic-component' and the muscle tension is passed to the bone by their tightening. This tension application moves the bone against a load.

There are 2 primary types of movement depending on whether the muscle changes length during contraction.

Isotonic contraction: In this type, muscle tension remains constant as the muscle changes length.

Isometric contraction: In this type, the muscle is prevented from shortening, so tension developed at constant muscle length. The same internal events occur in both types of contractions. Isotonic contractions are used for body movements and for moving external objects. The submaximal isometric contractions are important for maintaining posture and for supporting the object in a fixed position. (See figure 29). During a given movement, a muscle may shift between Isotonic and isometric contractions.

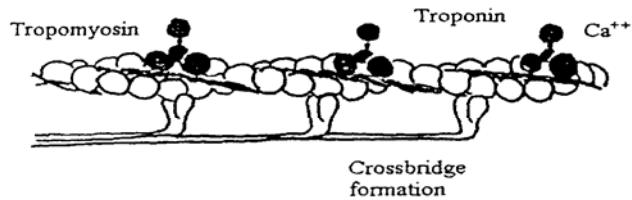

The tropomyosin moves deeper into the groove, exposing active site on actin.

- Crossbridge formation increases the tension of the muscle.
- Activated muscle does not shorten
- No change in the length of sarcomere
- A contraction can change from isotonic to isotonic and vice versa.

Body in an upright, balanced position

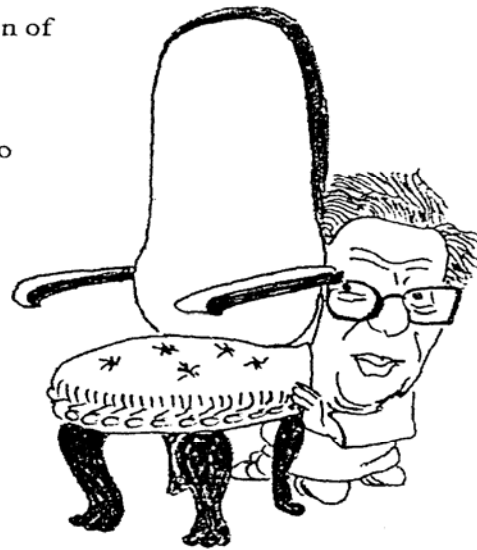

Force generation without shortening is a normal activity for postural muscle.

During isometric contraction, an the extra energy output is converted to heat

With the start of isometric exercise the heart rate rises, largely due to decreased vagal tone; SBP, DBP↑, SV changes little

Figure 29. Isometric (constant length) contraction

An isotonic contraction occurs if the loaded muscle contracts and lifts the weight.

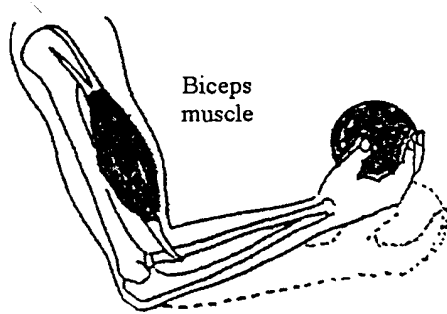

Contraction against a constant load, with approximation of the ends of the muscle.

Muscle varies in length when activated isotonic (dynamic) contraction.

It is more correct to use the term 'dynamic, exercise' than isotonic exercise when there is a movement in joints involved

ISOMETRIC TETANIC TENSION

The length tension relationship is based on the sliding filament theory of muscle contraction.

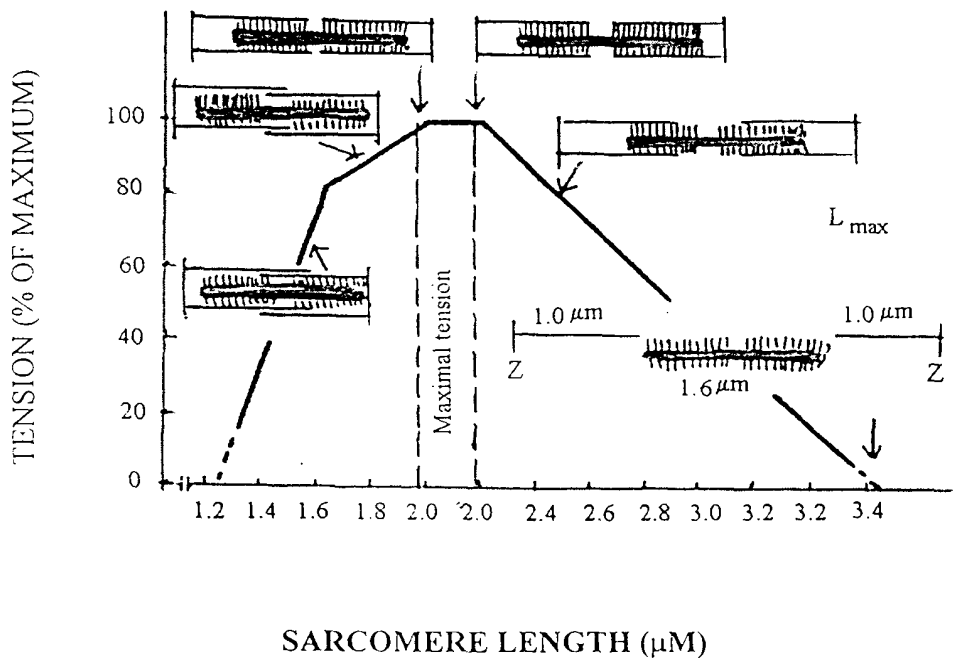

Figure 30. Isotonic contraction

Steps of Excitation-contraction coupling and relaxation

- Ach released from a motor neuron terminal initiates an action potential in the muscle cell that is conducted over the entire surface of the muscle cell membrane.
- The surface electrical activity is carried in to the central portion of the muscle fiber by the T-tubule.
- Spread of the action potential down the T- tubules triggers the release of Ca^{++} ions from the adjacent lateral sacs of sarcoplasmic reticulum.
- Released of Ca^{++} binds with troponin and changes its shape so that the tropomyosin-troponin complex is pulled aside, exposing actin's cross bridge binding site.
- Exposed actin binding site bind with myosin cross bridges which have previously been energized by the splitting of ATP in to $\text{ADP} + \text{Pi}$ energy by the myosin ATPase site on the cross bridge.
- Binding of actin and myosin at a cross bridge causes the cross bridge to bond producing a power stroke that pulls the thin filament
 - ADP and Pi are released from the cross bridge during the power stroke.
 - Attachment of a new molecule of ATP permits detachment of the cross bridge, which returns to its original conformation.
 - Splitting of the fresh ATP molecule by myosin ATPase energizes the cross bridge once again.
 - If Ca^{++} is still present so that the tropomyosin-troponin complex remains pulled aside.

Skeletal muscle metabolism

Three steps in the contractile process require ATP

1. Splitting of ATP by myosin ATPase providing energy for the power stroke of the cross bridge

2. Binding of a fresh molecule of ATP to myosin permitting detachment of the cross bridge from actin at the end of the power stroke so that the cycle could be repeated. This ATP provides energy for the next stroke of the cross bridge.
3. The active transport of Ca^{++} ions back in to the sarcoplasmic reticulum, is energy dependent.

Therefore, ATP must be continuously supplied for contraction activity to continue.

The muscle has small and limited source of ATP for its immediate needs. Three pathways provide additional ATP needed during muscle contraction.

1. Creatinine phosphate transfers high energy phosphate bonds to ADP
2. Oxidative phosphorylation - the citric acid cycle (Kreb's cycle) and electron transport system
3. Glycolysis - aerobic and anaerobic

SMOOTH AND CARDIAC MUSCLE

Smooth muscle shares some basic properties with skeletal muscle and also have some distinctive properties. The same is true for cardiac muscle.

Common features of the 3 muscles:

- All have specialized contractile proteins and made up of actin and myosin that slide past in response to rise in cytosolic calcium to achieve contraction
- All use ATP for cross bridge cycling

Different features:

- Structure variation as well as excitation
- The means by which excitation - contraction is coupled.
- There are distinct contractile responses.

Smooth muscle

The majority of these muscles are present in the walls of hollow organs, blood vessels and tubular structures in the body. Their contraction exerts pressure on the contents and regulates the forward movement of contents of these structures. Smooth muscles are spindle-shaped, have 1 nucleus and are much smaller in size (2-10 μm in diameter

and 50-100 μm in length). Groups of smooth muscles are typically arranged in sheets.

Three types of filaments present in smooth muscles are

- Thin actin filaments, which have tropomyosin but lack troponin
- Thick myosin filaments, longer than those found in skeletal muscles.
- Filaments of intermediate size - serve as part of the cytoskeleton framework that supports the shape of the cell, but does not directly participate in contraction.

Smooth muscles do not form myofibril and are not arranged in sarcomere pattern of skeletal muscle. Smooth muscles don't display striation. (See figure 31).

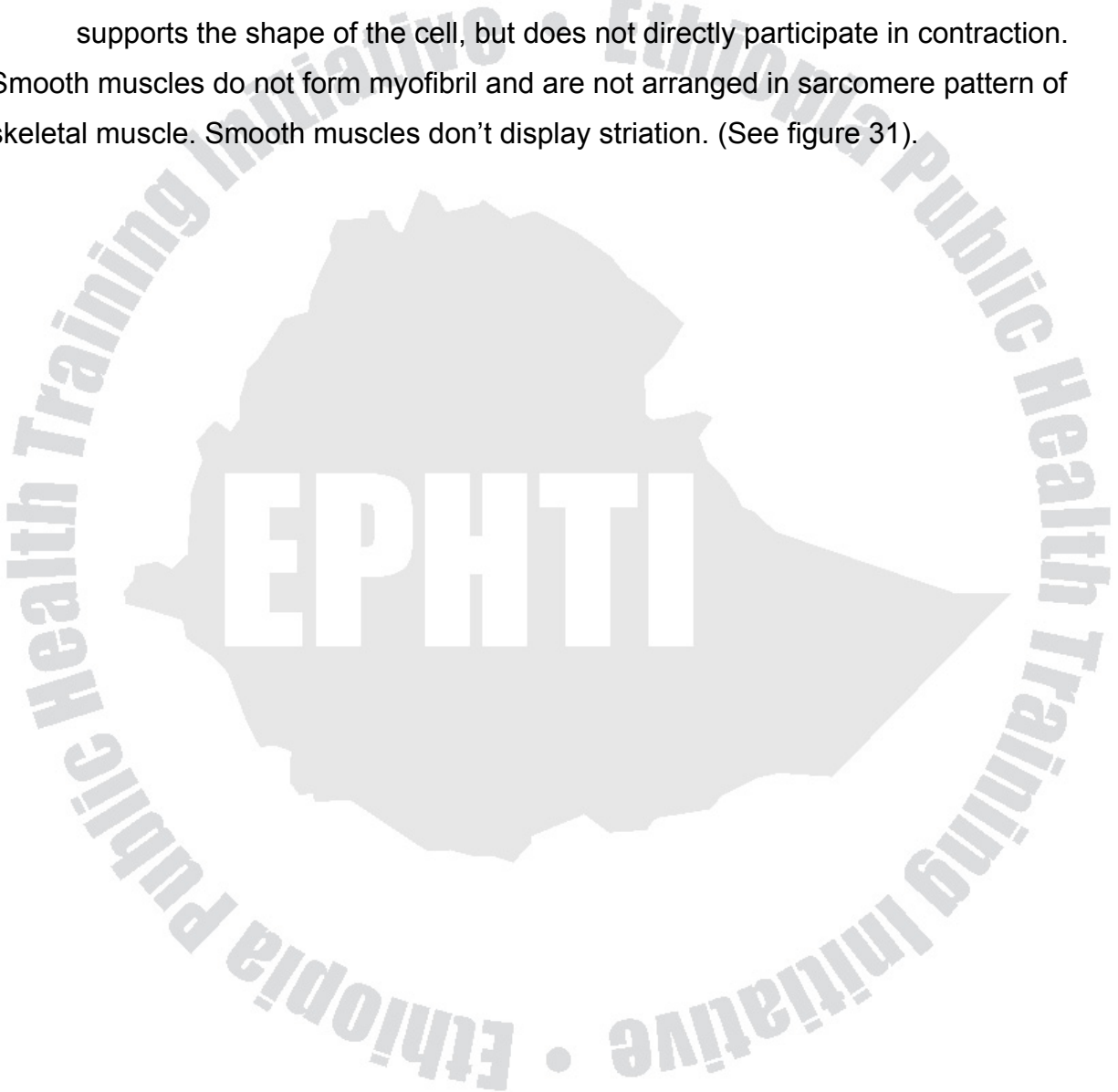

Dense bodis with noncontractile bundles of intermediate filaments.

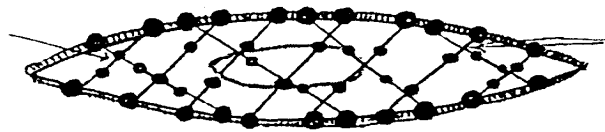

Contractile filaments containing actin and myosin anchored to sites in the plasma membrane

- Filaments form a loosely arranged contractile apparatus
- Filaments attached obliquely to the plasma membrane at disk like junctions connecting adjacent cells together
- Co
- Contains myosin and actin filaments; myosin has two heads and a long tail
- Most contain 10 to 15 actin filaments per myosin filament

Plasma membrane
Attachment side

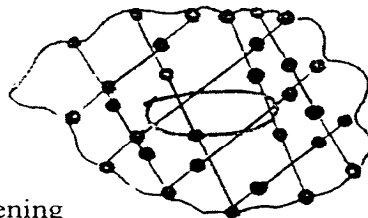

Cell shortening

CONTRACTION

Cytoplasmic dense bodies

Slow contraction than that of skeletal muscle high degree of shortening producing larg movements

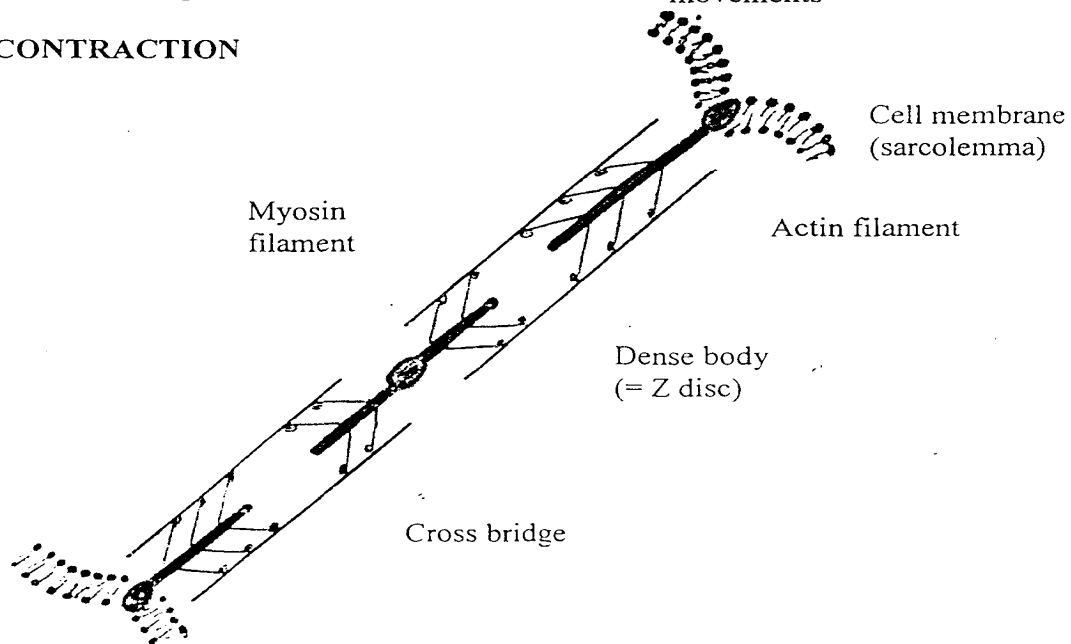

Figure 31. The contraction apparatus in a smooth muscle cell.

Calcium dependent phosphorylation of myosin

Smooth muscles do not have troponin and tropomyosin and do not block actin's cross bridge blocking sites, yet actin and myosin are prevented from binding in the resting state. Smooth muscle myosin interacts with actin only when the myosin is phosphorylated. During excitation, cytosolic Ca^{++} increases, that acts as an intracellular messenger, initiating a series of biochemical events that result in phosphorylation of myosin. In Smooth muscles Ca^{++} binds with calmodulin and intracellular protein similar to troponin in structure. This calcium- calmodulin complex binds to and activates another protein, myosin kinase, which in turn phosphorylates myosin. Phosphorylated myosin then binds with actin thin filament starting cross bridge cycle. (See figure 32).

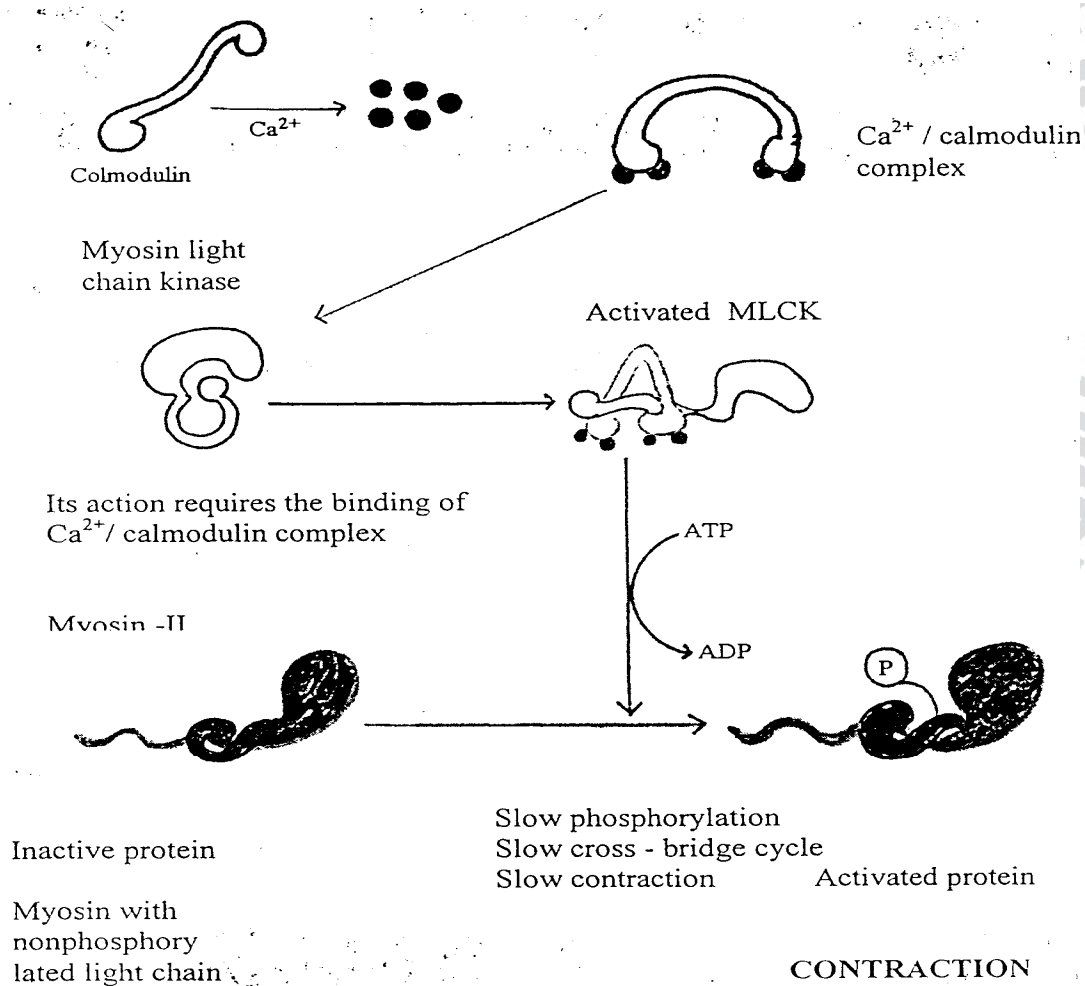

Figure 32. Regulation of smooth muscle contraction by Ca^{++}

MULTI-UNIT AND SINGLE UNIT SMOOTH MUSCLE

Multi- unit smooth muscle

- Multi- unit are discrete units that function independently of each other and separately contract, similar to skeletal muscle motor units.
- Contraction activity is neurogenic
- Innervated by autonomic nerves
- These types of smooth muscles are found in the large body vessels, in large airways to the lung, in ciliary muscles (the eye), that adjust the lens for near or far vision, in the iris of the eye, base of hair follicles.

Single- unit smooth muscle (visceral smooth muscles)

- Found in the walls of hollow organs/viscera - digestive, reproductive, urinary tract and small blood vessels.
- Single-unit is self excitable rather than needing nerve stimulation for contraction
- Cluster of cells show spontaneous electrical activity, undergoing action potential without any external stimulation
- Have 2 major types of spontaneous depolarization
 1. Pacemaker activity
 2. Slow wave potential

Slow contractile response of smooth muscle

A smooth muscle contractile response is slower than of muscle twitch. A single smooth muscle contraction may last as long as 3 sec (3000 msec) compared to the maximum of 100 msec for a single contraction response skeletal muscle. Smooth muscle also relax slowly because of slower rate of calcium removal.

CARDIAC MUSCLE

Cardiac muscle shares structural and functional characters with both skeletal and single unit smooth muscle.

- It is striated like skeletal muscle with highly organized actin and myosin in regularly banding pattern
- Cardiac muscle contain tropomyosin and troponin providing the site for calcium
- Have abundant mitochondria, myoglobin and T-tubules like skeletal muscles
- Like smooth muscles Ca^{++} enters both ECF and SR
- It has pacemaker activity but not slow wave action like single unit smooth muscle
- Cardiac muscle has gap junction for enhancing the spread of action potential throughout the heart
- Innervated by both ANS components.

References

1. Benett MVL, ed. Synaptic transmission and neuronal interaction
2. .Katz B. Nerve, muscle and synapse.
3. Ballock TH. Introduction to nervous system
4. Eccles JC. Physiology of Nerve cells
5. Eccles JC. The understanding of the brain
6. Kuffer SW and JG Nicholls. From neuron to brain.
7. Schmidt RF. Fundamentals of neurophysiology

STUDY QUESTIONS

1. Explain the ionic basis of resting membrane potential
2. Describe the genesis of graded potential and its characteristics and basis of IPSP and EPSP
3. Describe the generation of action potential, its phases, ionic basis and mode of propagation
4. What is a chemical synapse?
5. Describe the transmission of neural signals at the neuromuscular junction of skeletal muscle.
6. Describe the structure of skeletal and smooth muscles.
7. Discuss Excitation-contraction coupling

8. Discuss mechanism of contraction in striated and smooth muscles



CHAPTER THREE

THE CARDIOVASCULAR SYSTEM

Learning Objectives

After completing this chapter, the student is expected to know the following.

- Know the functions of plasma as carried out by plasma proteins.
- Know the structure and functions of erythrocytes, leucocytes
- Know the causes of the different types of anemia
- Understand the functions of platelets and vasopressin in injured blood vessel.
 1. Know the non-specific and specific immune response in immune system

THE BLOOD

Blood is the vehicle for long-distance, bulk transport of materials between cells and the external environment or between themselves. Such transport of substances is essential for maintaining homeostasis. It transports substances from place to place, buffers pH changes, carries excess heat to the body surface for loss, plays a very crucial role in the body's defense against microbes and minimizes blood loss by evoking homeostatic responses when a blood vessel is injured. Cells need a constant supply of oxygen to execute energy-producing chemical reactions that produce carbon dioxide that must be eliminated continuously.

Blood is about 8% of total body weight and has an average volume of 5 liters in women and 5.5 in men. It is estimated that there are perhaps 60,000 miles of blood vessels in an adult. A very tiny portion of the cardiac output passes through each capillary, bringing oxygen, nutrients, and hormones to each cell and removing carbon dioxide and metabolic end products (waste products).

Blood composition

Blood consists of erythrocytes, leukocytes, and platelets suspended in liquid called plasma. (Plasma= 5% of body weight). Because over 99% of the cells are

erythrocytes, the hematocrit, or packed cell volume (Hct or PCV), actually represents the total cell volume occupied by red cells. The white cells and platelet after centrifugation are packed in a thin, cream colored layer because they are colorless, the “buffy coat”, on top of the packed red cell column. The hematocrit averages 42% for women, 45% for men, with average volume occupied by plasma being 58% for women and 55% for men.

Functions of plasma proteins

Plasma proteins have a wide range of functions

- the colloidal osmotic pressure is the major force responsible for preventing excessive loss of plasma from the capillaries into the interstitial fluid and thus help maintain plasma volume
- Partially responsible to buffer pH changes
- Contribute to blood viscosity (RBC are more important)
- Plasma proteins are normally not used as metabolic fuels, but in a state of starvation they can be utilized to provide energy for cells

Each protein also provides a very specific function, such as

- Binding of substances for transport and contributes to the pressure
- Specific alpha & beta globulin transport thyroid hormone, cholesterol, iron
- Many clotting factors are globulins
- Inactive factors (precursor protein molecules) such as angiotensinogen is activated to angiotensin.
- Gamma globulin as antibodies, have a crucial role in body defense
- Fibrinogen provides the meshwork in clotting cascade.

Table 6. Blood constituents and their functions.

Constituent	Functions
I. Plasma (55%)	
(a) Water (91.5%) -----	<ul style="list-style-type: none"> ▪Acts as a solvent of different solutes ▪Carries heat
proteins (7%) -----	<ul style="list-style-type: none"> ▪Maintain osmotic pressure of blood ▪Participate in blood clotting ▪Defense against foreign invaders ▪Act as carriers for steroid hormones ▪Act as enzymes
Albumins (54%)	
Globulins (38%)	
Fibrinogen (7%)	
Others (1%)	
(c) Other solutes (1.5%)	
Waste products -----	<ul style="list-style-type: none"> ▪Excretion
Urea, uric acid, creatinine, bilirubin	
Nutrients -----	<ul style="list-style-type: none"> ▪Energy source
Amino acids, glucose fatty acids, glycerol	
Regulatory substances	
Enzymes	
Hormones	
Electrolytes -----	<ul style="list-style-type: none"> ▪Osmotic distribution of fluid between ECF & ICF ▪Acid-base balance
Cations: Na ⁺⁺ , K ⁺ , Ca ⁺⁺ , Mg ⁺⁺	
Anions: Cl ⁻ , HCO ₃ ⁻ , SO ₄ ²⁻ , HPO ₄ ²⁻	
II. Cellular elements (45%)	
(a) Erythrocytes -----	<ul style="list-style-type: none"> ▪Transport O₂ and CO₂
(b) Leukocytes	
Granulocytes -----	<ul style="list-style-type: none"> ▪Phagocytose bacteria and cellular debris ▪Attack parasitic worms
Neutrophils	
Eosinophils	
Basophils	
Agranulocytes	
Monocytes -----	<ul style="list-style-type: none"> ▪Phagocytic activity
Lymphocytes	
T-lymphocytes -----	<ul style="list-style-type: none"> ▪Cell-mediated immunity
B-lymphocytes -----	<ul style="list-style-type: none"> ▪Antibody-mediated immunity
(c) Platelets -----	<ul style="list-style-type: none"> ▪Hemostasis

Table 7: Elements of the blood

Cell	Normal range (cells/ μ l)
Total WBC	Average: 9000 Range: 4,000-11,000
Neutrophils	Average: 5400 Range: 3000-6000 (50-70% of total WBC)
Eosinophils	Average: 275 Range: 150- 300 (1 – 4% of total WBC)
Basophils	Average: 35 Range: 0 – 100
Lymphocytes	(20-40% of total WBC) Average: 2750 Range: 1500 – 4000
Monocytes	(5-8% of total WBC) Average: 540 Range: 300 – 600 (2 – 8% of total WBC)
Erythrocytes	
Females	4.8 million
Males	5.4 “
Platelets (thrombocytes)	Average: 300,000 Range: 200,000 – 500,000

Table 8: Plasma components and other characters

Water	91.5% of plasma volume
Proteins	7.0% “
Total (S)	6.0-8.0 g/dL
Albumin (S)	3.5-5.0 g/dL
Globulin (S)	2.3-3.5 g/dL
Fibrinogen	0.2-0.4 g/dL
Glucose (fasting)	70-110 mg/dL
Cholesterol (S)	120 –220 mg/dL (P)
Cholesterol esters	60 – 70% of total cholesterol
Lipids, total (S)	450 – 1000 mg/dL
Bilirubin (S)	up to 0.4 mg/dL - conjugated Up to 1.0 mg/dL - conjugated & free
Creatinine (S)	0.6-1.5 mg/dL
Urea nitrogen (BUN)	8-25 mg/dL
Uric acid (S)	
Women	2.3-6.6 mg/dL
Men	3.6-8.5 mg/dL
Lactic acid (B)	0.5-2.2 meq/L
Pyruvic acid (P)	0-0.11 meq/L
Osmolality (S)	280 –296 mosm/kg of water
pH (B)	7.35-7.45
Other solutes:	
Bicarbonate	21-27 mEq/L
Calcium (S)	8.5-10.5 mg/dL; 4.3-5.3 mEq/L
Chloride (S)	100-108 mEq/L
Iron (S)	50 – 150 µg/dL (S)
Iodine, Protein –bound	3.5 – 8.µg/dL (S)
Magnesium (S)	1.5 – 2.0 mEq/dL
Phosphatase	1.8-2.6 mEq/dL

Potassium	4.0-4.8 mEq/dL
Sodium (S)	135 – 145 mEq/dL
Sulfate (S)	2.9 – 3.5 mg/dL

Some enzymes:

Amylase (S)	53 – 123 U/L
Phosphates, acid (S)	0-0.8 U/L (prostatic)
“ , alkaline	13-39 U/L (adults)
Transaminase (S)	7 – 27 U/L (SGOT)

Arterial tension of blood gases:

Carbon dioxide (B)	35-45 mm Hg
Oxygen (B)	75 – 100 mm Hg.

Table 9: Important Carrier Proteins of Plasma

Protein	Materials bound
Albumin	Fatty acids, bilirubin, many drugs, heme, thyroxine
Apolipoproteins	Triglycerides, phospholipids, cholesterol
Haptoglobin	Plasma hemoglobin from lysed red blood cells
Hemopexin	Heme from plasma hemoglobin
Transferrin	Iron
Ceruloplasmin	Copper
Prealbumin	Thyroxine, vitamin A
Transcortin	Cortisol
Transcobalamin	Cobalamin (vitamin B ₁₂)

ERYTHROCYTES

The red blood cells (erythrocytes) harbour millions of hemoglobin molecules and thus carry them in circulation. They are biconcave disks, manufactured in the red bone marrow, losing their nuclei before entering the peripheral circulation. In human body, they have a life of an average 120 days. Red cells having nuclei seen on the peripheral smear suggest an underlying disease state. Their biconcave shape gives them enough

flexibility so they can easily pass through small capillaries to deliver oxygen to the tissues.

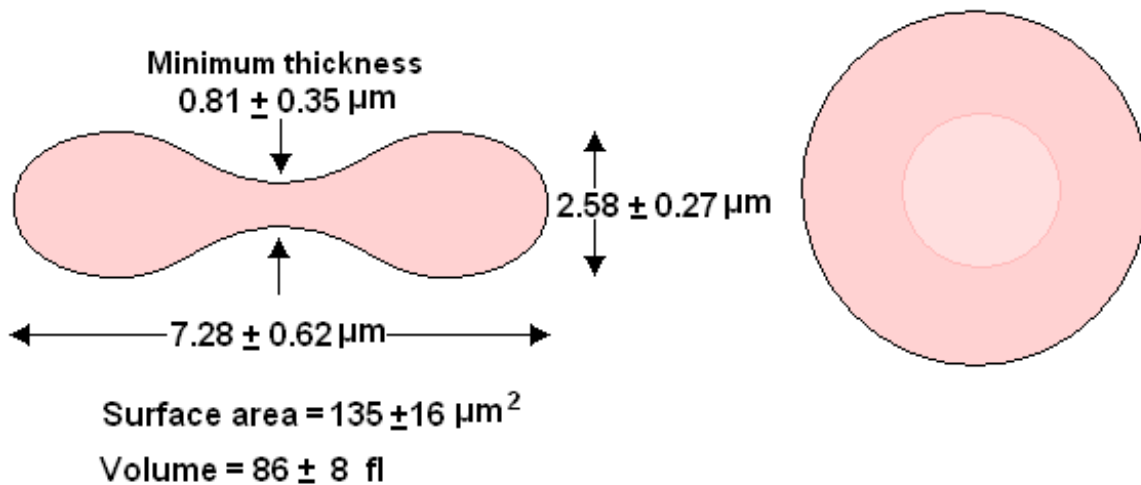

Figure 33. Shape and dimensions of a mature RBC

RBC Morphology and Other Features (see figure 33)

Hemoglobin (gm/dL) Mean= 16.0 (males); 14.0 (females)

Range= 14.0-18.0 (95% range in men; 12.0-16.0 (85% in women)

Packed cell volume (PCV, L/L)

Males = mean 0.46; range 0.41-0.51 (95% range)

Females= mean 4.8; range 4.2-5.5 (85% range)

Erythrocyte indices in normal adults:

MCV (mean cell volume) = 82 – 101 femoliters per cell

MCH (mean cell hemoglobin) = 27 – 34 picogram per cell

MCHC (mean cell hemoglobin concentration) = 31.5 – 36.0 grams/deciliter

The structure of erythrocytes is well suited to their primary function of oxygen transport in the blood.

Hemoglobin

It is the major constituent of the red cell cytoplasm, accounting for about 90% of the dry weight of the mature cell. (see fig. 34)

Functions

- (1) Transports oxygen and carbon dioxide in the blood
- (2) Maintains acid-base balance in the blood by its buffering action.
- (3) By its inclusion in the RBC, it reduces the viscosity of the blood

Structure

Hemoglobin is a conjugated protein with mol wt of approximately 64,500. Heme makes up 3% of the molecule whereas globin makes up remaining 97%. Heme contains a **porphyrin** molecule namely **protoporphyrin** with iron at its center. **Protoporphyrin IX** consists of 4 **pyrrole rings** to which 4 methyl, 2 propionyl and 2 vinyl groups are attached. The iron atom is in **ferrous (Fe^{++}) state** in the heme of functional hemoglobin. Iron is held at the center of the heme by 4 nitrogen of porphyrin ring. The iron can form 6 coordinated bonds. The other 2 bonds (besides 4 nitrogen) are formed on either side of the planar porphyrin ring. On one side, iron binds with the globin. On the other side, it binds with oxygen. The affinity of hemoglobin for oxygen is affected by *pH*, *temperature*, and *2, 3-diphosphoglycerate* concentration. These factors facilitate oxygen uptake in the lungs and its release in the tissues.

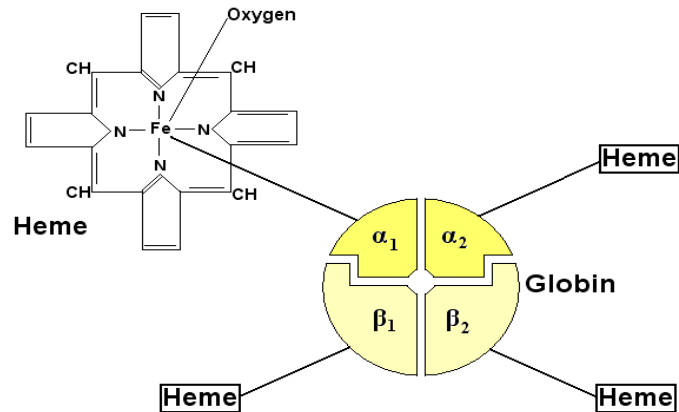

Figure 34. Structure of a hemoglobin molecule

Globin is a tetramer, consisting of two pairs of polypeptide chains. To each of the 4 chains is attached heme. Changes in the polypeptide subunits of globin can also affect the affinity of hemoglobin for oxygen. The major normal variants of hemoglobin, depending on its variation of globin chain is as follows:

Table 10. The major normal variants of hemoglobin

Name	Designation	pl. structure	Adults	Newborns
Adult hemoglobin	HbA	β_2	>95%	20%
Hemoglobin A ₂	HbA ₂	δ_2	<5%	0.5%
Fetal Hemoglobin	HbF	γ_2	<5%	80%
Glycosylated hemoglobin	HbA _{1C}	β_2 -glucose	<5%	0
Portland		γ_2	0	0
Gower I		ϵ_2	0	0
Gower II		ϵ_2	0	0

Abnormal or genetic variants of hemoglobin (Hemoglobinopathies)

Sickle cell hemoglobin (HbS)

This is the most common disorder of Hb. It primarily occurs in the black population affecting 1 in 500 newborn black infants in USA. A molecule of HbS contains two normal α -chains and two mutant β -globin chains (β^s) in which glutamate at position 6 has been replaced with valine.

Hemoglobin C (HbC) or Cooley's Hemoglobinemia

It is characterized by substitution of glutamate by lysine in the 6th position of β chain. HbC occurs mainly in blacks. Both homozygous and heterozygous individuals of HbC are known. This disease is characterized by mild hemolytic anemia. No specific therapy is recommended.

Thalassemias

The thalassemias are the result of absent or defective synthesis of either the α or β -chain of the Hb molecule. Thalassemia is also inherited as an autosomal co-dominated (recessive) trait.

(1) β -Thalassemia (Cooley's anemia or Mediterranean anemia)

In β -thalassemia, *β -globin chain synthesis is either markedly deficient (β^+ thalassemia) or absent (β^0 -thalassemia)*. The β -thalassemias, sometimes, called Cooley's anemia or Mediterranean anemia, are most common in the Mediterranean populations e.g., southern Italy and Greece.

(a) β^+ thalassemia

This is the commonest type of β thalassemia and is associated with reduced synthesis of β -globin chains having the normal sequence of amino acids. The deficiency in β -globin synthesis (5 to 30% of normal level) is closely paralleled by a deficiency in β globin mRNA.

(b) β^0 -thalassemia

In this form of thalassemia, there is total absence of β -chain synthesis.

(2) α -thalassemia

The molecular basis of α -thalassemia is quite distinct from that of β -thalassemia. A majority of the α -thalassemias are due to *deletion of α -globin gene loci*. Since in most populations there seem to be two α -globin genes per chromosome, there are 4 possible severities of α -thalassemia based on loss of 1 to 4 α globin genes. On one end, a single α -gene loss is associated with a silent carrier state, whereas, deletion of all four α -genes is associated with fetal death in utero.

Catabolism of hemoglobin: degradation of heme, formation of bilirubin.

Old red blood cells at the end of their life span are destroyed in the tissue macrophage system of the spleen, the globin portion of the hemoglobin molecule is split off, iron is retrieved and stored for further use, and the heme is converted to biliverdin, most of which is changed to bilirubin. Heme degradation occurs in the reticuloendothelial cells, particularly in the spleen and liver. Bilirubin and its derivatives are termed bile pigments. Bilirubin binds noncovalently to albumin for transport in plasma. It dissociates from the carrier albumin and enters a hepatocyte, where it undergoes conjugation with glucuronic acid that increases the solubility of albumin in aqueous solution. This leads to formation of conjugated bilirubin comprising both mono- and diglucuronides which have high water solubility. The bilirubin is taken to the small intestine for fecal excretion.

Hematopoiesis

The blood contains several different types of blood cells. Each of these cell types is quite distinct in appearance and each has a specific biological function. Despite the extreme structural differences among the cells of the blood, strong evidence exists that all of the blood cells are the progeny of a single type of cell: the ***hematopoietic stem cell*** (or ***pluripotent hematopoietic stem cell*** or ***hemocytoblast***). The process in the production of all the various cells of the blood from the hematopoietic stem cells is called ***hematopoiesis***. Hematopoiesis begins early during embryogenesis, and the process undergoes many changes through fetal and neonatal development. Unlike organ systems that are formed in early life and continuously replaced, the hematopoietic systems undergo turnover and replenishment throughout life.

Hematopoietic organs

The organs, in which blood cells are produced, are called hematopoietic organs. The hematopoietic organs change from time to time in different stages of our life.

Early embryogenesis: **Yolk sac**

Early fetal life: **Liver and spleen**

Late fetal life- **bone marrow**

After birth:

Before adolescence- the bone marrow of all the bones

After adolescence - the bone marrow of only the spine, ribs, pelvis, and upper parts of humerus and femur

Formation of different blood cells from stem cells

Figure 35 shows the successive divisions of the hematopoietic stem cells from which all the cells in the circulating blood are derived. As these stem cells reproduce, continuing throughout the life, a portion of them remains exactly like the original stem cell (PHSC) and is retained in the bone marrow to maintain a supply of these. The larger portion of the reproduced stem cells, however, differentiates to form other cells. The early offspring still cannot be recognized as different from the PHSC, even though they have already been committed to a particular line of cells. These early offspring of cells are called committed hematopoietic cells. The different committed hematopoietic cells, when grown in culture, will produce colonies of specific types. A committed stem cell that produces erythrocytes is called a colony forming unit-erythrocyte (CFU-E). Likewise, colony-forming units that form granulocytes and monocytes are called CFU-GM.

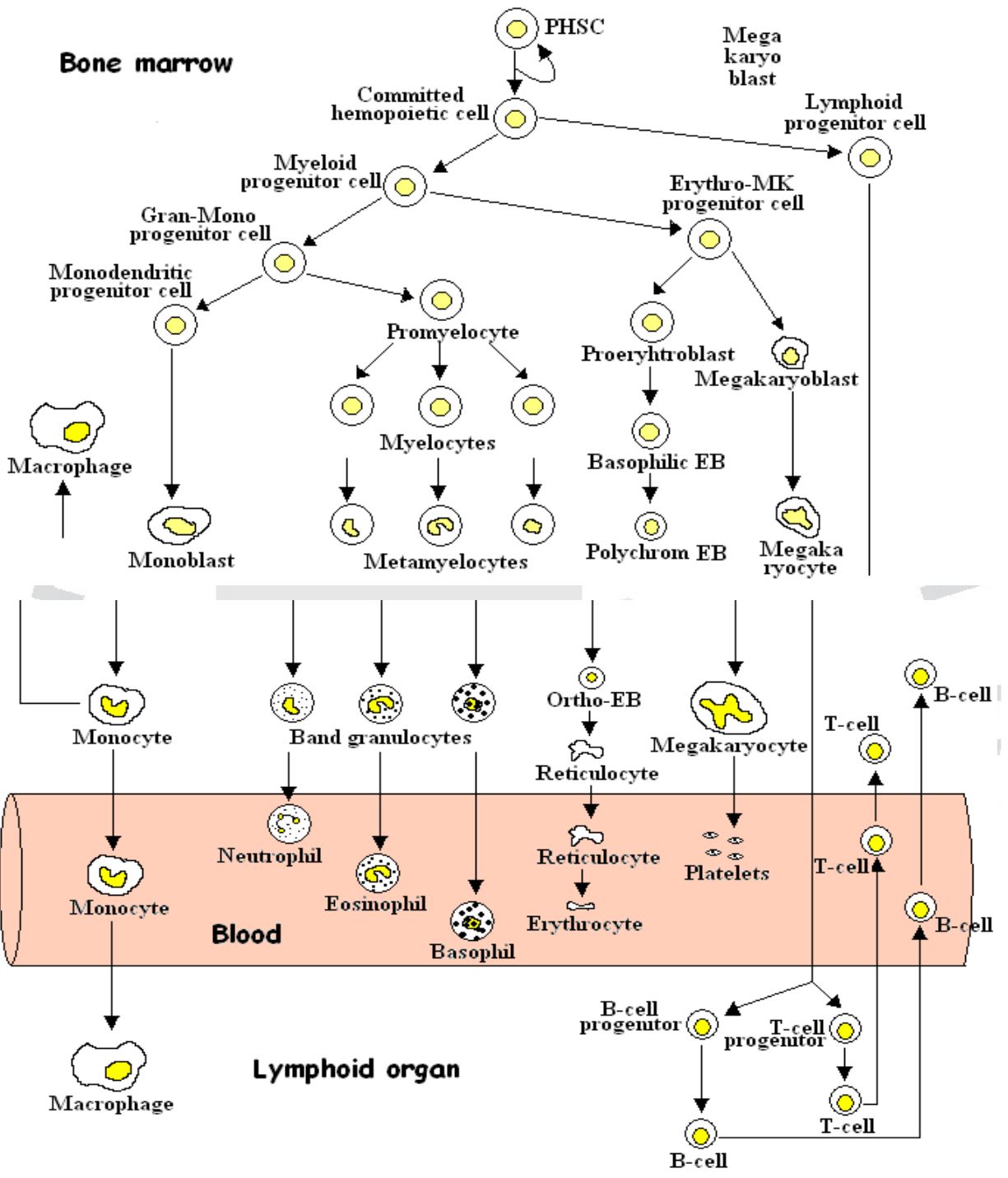

Figure 35. Hematopoiesis

Erythropoiesis:

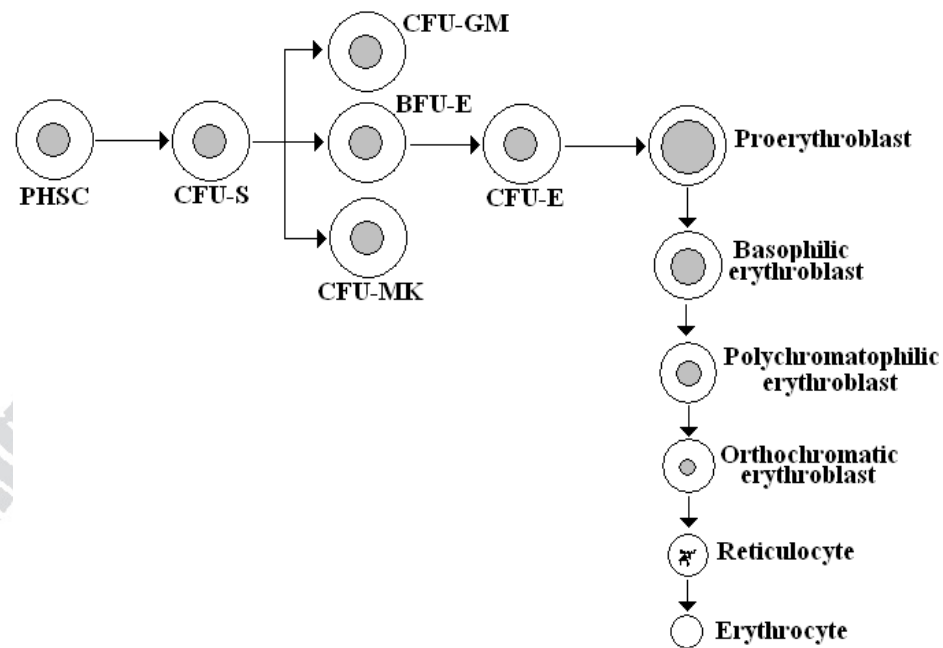

Figure 36. Stages of erythropoiesis

Factors stimulating/assisting erythropoiesis

- (1) Tissue hypoxia
- (2) Erythropoietin (EPO)
- (3) Nutritional factors
 - Protein and amino acids
 - Vitamin B₁₂ and Folic acid
 - Other vitamins
 - Vitamin B₆
 - Vitamin B₂
 - Nicotinic acid (niacin)
 - Vitamin C
 - Vitamin A
 - Vitamin E
 - Minerals
 - Iron
 - Copper

- Cobalt

(4) Other hormones

- Androgens
- Estrogens
- Thyroxine, cortisol, and growth hormone

BLOOD GROUPS AND BLOOD TRANSFUSION

The ABO System

It is most important system for transfusion therapy. Each antigen has a chain of sugars at its terminal free end. Group ‘O’ cells have large amounts of the ‘H’ antigen, which is precursors of all ABO antigens. ABO antigens are widely distributed on all tissues through out the body, and are found in body fluids. ABO antigens are inherited. Each person inherits two genes.

Table 11: Summary of ABO system

Blood type	Agglutinins In plasma	Frequency in USA	Plasma agglutinates red cells of: Type
O	Anti-A & Anti-B	45%	A, B, AB
A	Anti-B	41%	B, AB
B	Anti-A	10%	A, AB
AB	None	4%	None

Rh System

The system is important both because the antigens are potent immunogens compared to other blood groups and the antibodies are clinically significant. Among whites 85% are Rh-positive and 15% are Rh-negative. Rh antigens are inherited almost as one gene. This is helpful in predicting the Rh type of a fetus carried by an Rh-negative mother, and in paternity testing. Rh antigens are presumed to be proteins and are important in providing the stability of the red cells membrane.

Antibodies to Rh system antigen occur only after a person has been sensitized to the antigen 'D' through blood transfusion or pregnancy. Because D antigen is the strongest antigen (immunogen) of red cell antigen, this may occur in up to 70% of such persons. Sensitization may also occur in an Rh-negative mother carrying an Rh-positive fetus, most commonly at the time of birth, when fetal cells escape into the maternal circulation. All of these immune antibodies are IgG. Fortunately these antibodies do not fix complement and the red cell destruction is mild and extra vascular.

Kell, Duffy, and Kidd Blood Group Systems

Antigens in these systems may each lead to the development of immune antibodies after an antigen-negative individual is exposed through transfusion or pregnancy. These antibodies at times can cause severe hemolysis. Such patients must be given antigen-negative transfusion.

Compatibility Testing

Because most patients have naturally occurring antibodies, and some develop immune antibodies in other blood group systems that are clinically significant, the choice of red cells for transfusion is to be done carefully to avoid life-threatening hemolytic transfusion reactions.

Red Cell Typing

The patient's ABO typing is determined from both forward and backward typing. In Rh forward typing is done, because very few have anti-D.

Antibody Screen

The patient's serum is tested for "unexpected" (i.e. non-ABO). Antibodies at room temperature (for IgM) as well as at 37 Celsius (for IgG). It is some times called the "indirect Combs test".

Cross match

The absence of agglutination is important for a compatible cross match. Potential donor components are chosen to match the patient's red cell type. If any other antibodies have been found, the donor's red cells must be negative for the corresponding antigens. Finally, two drops of the donor's cells must be mixed with the patient's serum at room temperature, at 37°C, and after the additions of the Coombs reagent.

Table 12: ABO Blood Groups: genotype and phenotype

Phenotype	Genotype	Antibody	Forward type patient		Back type patient	
			Cell with Anti-A	Cell with Anti-B	Serum with A cells	Serum with B cells
A	AO	Anti-B	+	+	+	+
	AA					
B	BO	Anti-A	-	-	-	-
	BB					
AB	AB	None	+	+	+	+
O	OO	Anti-A & Anti-B	-	-	-	-

+ = positive: - =negative

Table 13: Choosing ABO-compatible red cells for transfusion

Patient blood type	Safe donor types			
	A	B	AB	O
A	Yes	Yes	Yes	Yes
B	No	No	No	No
O	No	No	No	No
AB	yes	yes	yes	Yes

Blood Component Therapy

Components preparation allows better storage of individual components. E.g. red cells are stored at 1 to 6 C while platelets require room temperature. Factors from plasma can be concentrated

Whole Blood

Platelets and plasma are separated from the red cells shortly after donation, and plasma may be further fractionated. Each unit is 450-50 ml blood mixed with 63 ml anticoagulant and red cell preservative solution such as CPDA -1. Such preservatives include citrate, which binds with calcium, and phosphate, dextrose, and adenine, to improve red cell survival.

Packed Red Cells: Most anemic should be transfused with packed red cells, after removing 80% of the plasma, so that the volume of the component is about 150 ml. One unit of packed red cells raises recipient's hematocrit by 3 percent.

White-cell-poor Red cells

Packed cell still contain WBC, which may cause development of HLA-antibodies in response to previous transfusions or pregnancy may have febrile transfusion reactions because of the presence of donor white cells. WBC can be removed by centrifugation, or with the use of special filters.

Washed Red Cells

Such preparations are needed for individuals who are IgA deficient and have had a life-threatening reaction to plasma containing IgA. The washing procedure also removes WBC. The washed red cells must be used within 24 hours to avoid growth of contaminating bacteria.

Frozen Red Cells

Packed red cells can be stored for 42 days. Membrane and metabolic changes occur to the red cells during this storage 1 - 6⁰C. It is possible to freeze cells at -70⁰C for as

long 10 years. Freezing requires the addition of glycerol, a cryoprotectant that enters the cells and limits the formation of intracellular crystals. Glycerol is removed before transfusion.

Platelets

Platelets are concentrated by centrifugation and stored at 20-24°C since refrigeration destroys their ability to aggregate. Storage is allowed up to 5 days.

Granulocytes

Pheresis techniques are used to obtain concentrates of WBC from normal donors for treating severely neutropenic patients. Granulocytes must be transfused as soon as collected, since it is not possible to preserve their function by storage at any temperature. Granulocyte transfusions are frequently accompanied by fever and respiratory symptoms in the recipient; these reactions can often be fatal.

Fresh Frozen Plasma

FFP is used to correct severe coagulopathies due to multiple factor deficiencies. It is not practical for treating hemophilia A.

Cryoprecipitate

The preparation of cryoprecipitate concentrates factor VIII is used for treating hemophilia A and von Willebrand's disease. The half-life of transfused factor VIII is 8 to 12 hours. Cryoprecipitate also corrects bleeding in uremia.

Clotting Factor Concentrate

Specific factors such as F VIII can be concentrated; factor IX has been made available by this method. It may cause thrombosis and DIC and so must be used with caution.

Albumin

It is used as a replacement fluid during plasma exchange. It is prepared by heating plasma at 60°C over a long period to make it free from infections

LEUKOCYTES

Leukocytes primarily function outside the blood. Leukocytes are the mobile components of the body's defense immune system. Immunity means the body's ability to resist or eliminate harmful foreign materials or abnormal cells.

The leukocytes and their derivatives defend against invasion by disease-causing microorganisms by phagocytizing the invaders or causing their destruction by more complex means; identify and destroy cancer cells that arise within the body phagocytize cellular debris resulting from dead or injured cells; it is essential for wound healing and tissue repair.

The leukocytes go to sites of tissue damage or invasion. They are present in the blood as transit passengers. They can be rapidly transferred from their site of production or storage to where ever they are needed

There are five different types of leukocytes

Leukocytes vary in number, function, and structure. Five different cells - neutrophils, eosinophils, basophiles, monocytes and lymphocytes - each have different characteristic **morphology and function**.

Neutrophils, eosinophils, and basophiles are classed as polymorphonuclear granulocytes. (See figure 38). They are classified on the basis of varying affinity of their granules to the red dye eosin and basic dye methylene blue. Monocytes and lymphocytes are mononuclear agranulocytes

Leukocytes are produced at varying rates depending on the changing needs for defense of the body

All leukocytes originate from the same undifferentiated pluripotential stem cells in the red bone marrow that also produce erythrocytes and platelets

The bone marrow produces all circulating blood cells except lymphocytes, which are produced by lymphocyte colonies in lymphoid tissues. Precursor cells for the colonies are from the bone marrow.

Erythrocytes.
hemoglobin
CO₂ and O₂ transport

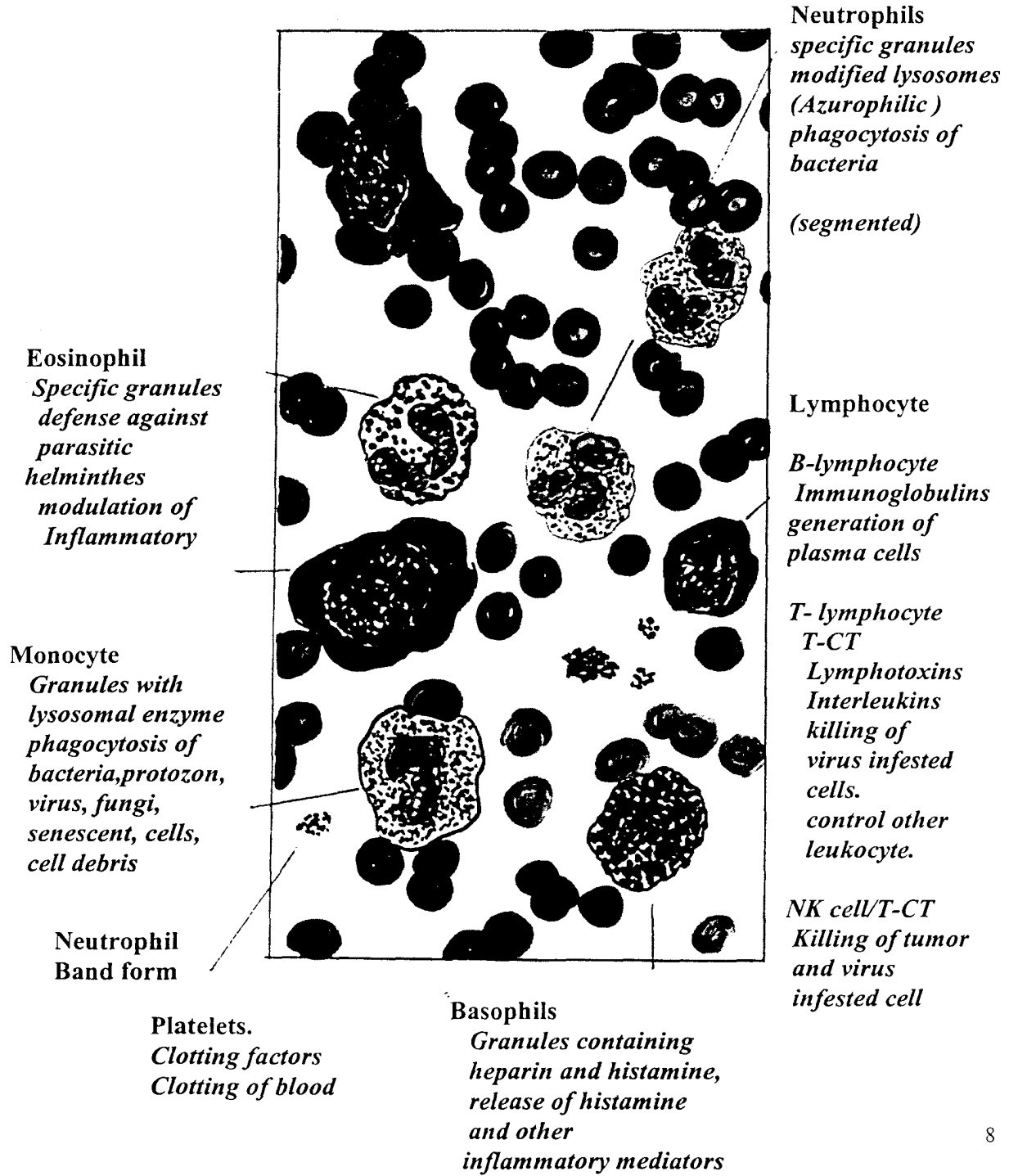

Figure 37. Products and functions of blood cells

Neutrophilic
granulocyte
60-70%

2-5 lobes (usually
3) of a nucleus

12-15um dia.
1/2t 6-7hrs in blood
1-4 days in CT
Terminal cells

Phagocytic
Survive in anerobic environment (e.g.
inflamed/ necrotic tissue)

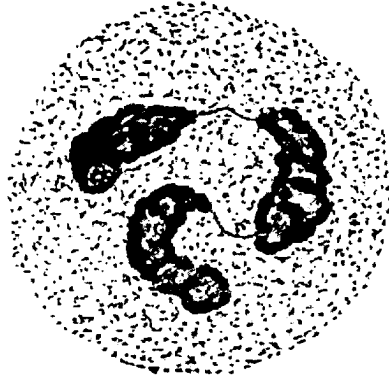

Specific grnules (round to elongated)

Alkaline phosphatase
Collagenase
Lactoferrin
Lysozyme

Azurophilic granules (~0.5um dia)

Acid phosphatase
-Mannosidase
Arylsulfactors
B-Galactosidase
B-glucuronidase
Cathepsin
5-Nucleotidase
Elastase, collagenase
Myeloperoxidase
Lysozyme
Acidic mucosubstances
Cationic antibacterial proteins

Eosinophil 2-4
%



12-15um dia.

Specific granules (~200/cell)

Acid phosphatase
Arylsulfatase
B-Glucuronidase
Cathepsin
Phospholipase
RNAase
Eosinophilic peroxidas
Major basic protein
(arginine residues)

Basophil
0-1%

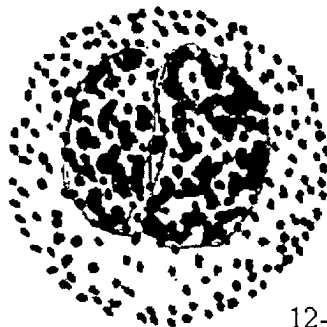

12-15um dia

Specific granules

Eosinophilic chemotactic factor
Heparin
Histamine
Peroxidase

Figure 38A. Granulocytes

Granulocytopoiesis and Monocytopoiesis

Neutrophils and monocyte, which transform into macrophages into the tissues, arise from a common committed progenitor the CFU-GM. The myeloblast is the earliest recognizable precursor in the granulocyte series that is present in the red bone marrow. A series of four to five divisions are associated and the mature neutrophil, cytoplasmic granules develop. The cell division and maturation sequence continues. The bone marrow contains a large form of band forms and mature neutrophils. On entering the peripheral blood, neutrophils are almost equally divided into circulating and marginal pools, which are in a dynamic equilibrium. Thus, a large reserve capacity of phagocytes is available in the bone marrow, and a large fraction of the neutrophils present in the peripheral blood; they are ready for egress into the tissues in response to infection or inflammation. The average time from the start of granulopoiesis to the entry of the mature neutrophil into circulation is 10 to 13 days. The mature neutrophil remain in the blood for only about 10 to 14 hours before entering the tissues, where it soon dies after performing phagocytic function.

There is no reserve pool of monocytes in the bone marrow. Monocytes spend a short time in the circulating blood before entering the tissues. However, they survive in tissues for variably long period; they become transformed into macrophages, long-lived phagocytic cells that retain some capacity for continuing cell division. The so-called mononuclear phagocyte system, include alveolar macrophages. Kupffer's cells, osteoclasts are derived from monocytes

Table 14: The major hematopoietic growth factors for leukocytes

Growth factor	Target cells
	Early stem / progenitor cells
Stem cell factor	CFU-GM,CFU-eos,CFU-G CFU-M
Interleukin-3	CFU-GM,CFU-eos, CFU-G,CFU-M,
GM-CSF	Maturing neutrophils, monocyte, eosinophils
G-CSF	CFU-G, maturing neutrophils
M-CSF	CFU-M, maturing monocytes, macrophages

Hematopoietic growth factors enhance the growth of the corresponding progenitor cells but also increase the rate of mitosis of the precursor cells. They cause differentiation and preparation for their phagocytic function. IL-5 and IL-6 have effect on more than one lineage. There are other growth factors that promote the growth and differentiation of eosinophils and lymphoid cells. The mechanism that regulates the production of GM-CSF, G-CSF, and M-CSF and other growth factors are complex. Activated monocytes and macrophages in areas of infection or inflammation release these factors, such as IL-3, TNF, and other “monokines”. These intermediates in turn act on T lymphocytes, endothelial cells, and fibroblasts for the production of the various types of CSF that influence the functional capacity of phagocytes in battles with infection or inflammation. Negative regulatory factors also play a role. Lactoferrin produced by neutrophils in inflammatory exudates acts as an inhibitor of CFU-GM development. Prostaglandin E produced by macrophages inhibit the production of monocytes, and to some extent of neutrophils.



Health Trust

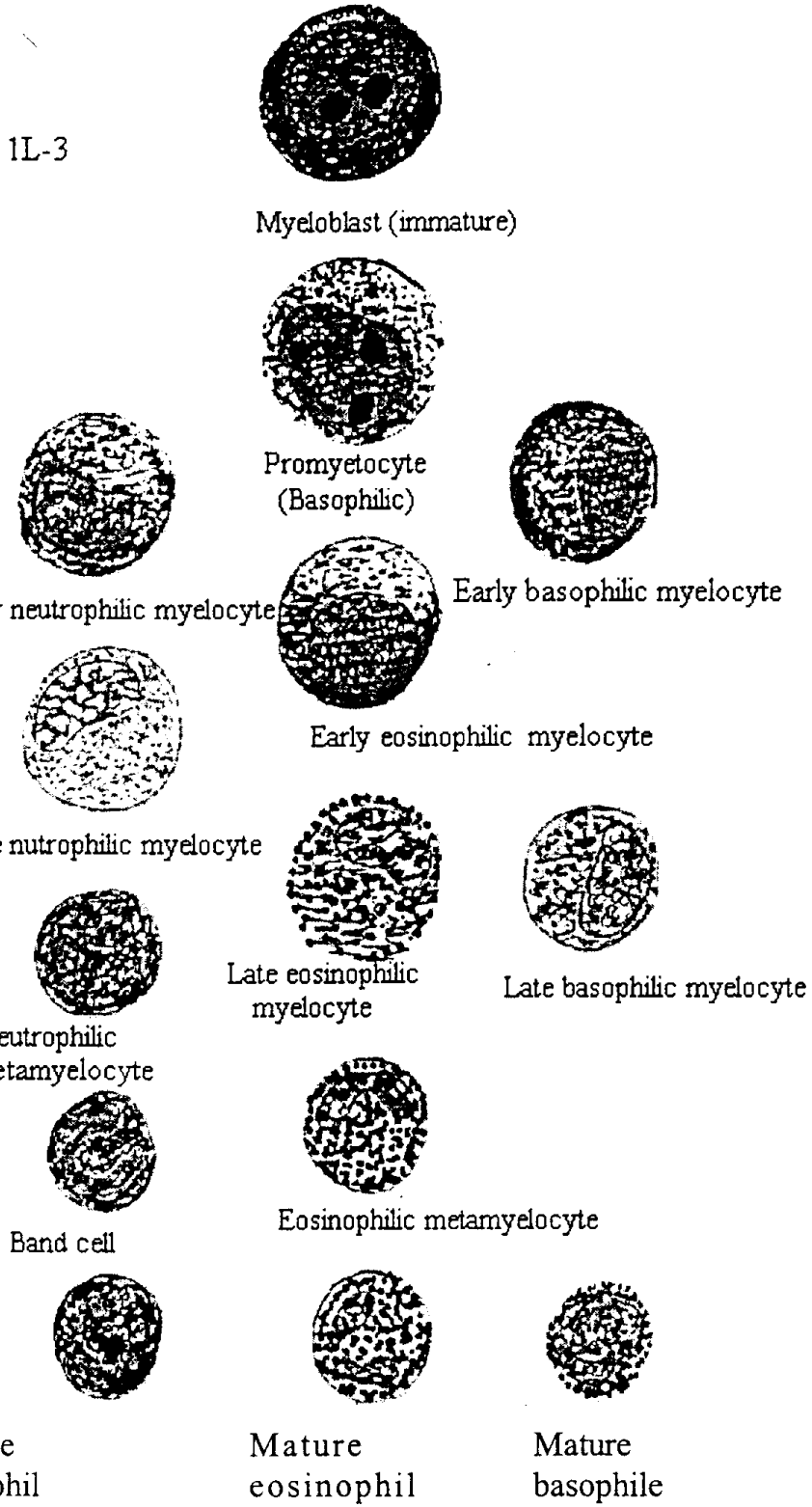

Figure 38B. Stages of development of granulocytes

Table 15: Normal values for Leukocytes

Cell	Cells/uL	Approximate range	Percent
Total WBC	9000	4000-11000	
Neutrophils	5400	3000-6000	50-70
Eosinophils	275	150-300	1-4
Basophils	35	0-100	0-4
Lymphocytes	2750	1500-4000	20-40
Monocytes	540	300-600	2-8

NEUTROPHILS

- neutrophils are phagocytic cells and are the first defenders in combating bacterial invasion and are thus, very important in inflammatory responses
- they scavenge to clean up debris
- to maintain their normal circulating levels, over 100 billions neutrophils are produced daily, they enter tissues by first adhering to the endothelium by binding to adhesion molecules of the integrin family; they then migrate between the endothelial cells by 'diapedesis'
- chemotactic agents released during inflammation attract neutrophils to the infected area (chemotaxis); chemotactic agents include C5A, leukotrienes, and polypeptides from mast cells, basophiles, and lymphocytes
- coated bacteria by opsonins (IgG and complement protein C3) are endocytosed by neutrophils - phagocytosis
- activated neutrophils result in degranulation
- in sensitized neutrophils NADPH oxidize inactivated, with the production of toxic oxygen metabolites; these metabolic oxidants and the proteolytic enzymes from the neutrophil granules are responsible for killing ingested bacteria
- O₂ and hydrogen peroxide are very potent bactericidal agents
- Hypothalal acids are produced by catalytic action of the enzyme myeloperoxidase, which are very potent oxidants
- Neutrophil granules contain variety of proteases which cooperate with metabolic oxidants in killing bacteria; neutrophils also cause local destruction of host tissue

EOSINOPHILS

The eosinophils undergo same stages of development as neutrophils, but content and types of granules are different

Eosinophils are recruited to sites of allergic reactions by chemotactic factors, the most potent of which is the lipid called platelet-activating factor. In addition, lymphokines and interleukin-5 can cause accumulation of eosinophils in tissues. Eosinophils release several granule derived cationic proteins, including major basic proteins that cause local tissue damage in diseases such as asthma and the hypereosinophilic syndrome. These cationic proteins are beneficial when released as part of eosinophil count is found during most bacterial and viral infections. Stress, endogenous secretion of corticosteroids and exogenous glucocorticoids suppress the number of blood eosinophils

Eosinophils cannot engulf a much larger parasitic worm, but they do attach to the worm and secrete substances that kill it.

BASOPHILS

Another type of leukocyte with specific granule is the basophil. Basophil granules have a high content of histamine and play a role in acute, allergic reactions. They have high affinity Fc receptors for IgE. Binding of antigen to adjacent cell-bound IgE triggers the release of mediators from basophils. They are quite structurally and functionally similar to mast cells. Both synthesize and store histamine and heparin. Mast cells, however, are not present in the blood, but are found in the bone marrow and in mucosal and connective tissues. Basophilia is most often found with myelocytic leukemia and other myeloproliferative disorders.

The events resulting from the release of contents of basophil or mast cells include:

- increased vascular permeability
- smooth muscle spasm
- mucus secretion
- eosinophil and neutrophil chemotaxis

- pruritis, and
- vasodilatation

Urticaria, rhinitis, asthma, dermatographism, may result from this process

LYMPHOCYTES

The primitive multipotential stem cell that gives rise to the granulocytes, red cells, and platelets, is also the precursor of the lymphocyte. The lymphoid precursor cells travel to lymphoreticular organs, where they differentiate into cells capable of either expressing cell-mediated immune responses or secreting immunoglobulin. Antibody-producing cells probably processed by the tonsils or bone marrow (bursa of Fabricius) and T cells differentiate in the thymus gland. B cells ultimately differentiate into antibody-producing plasma cells. In normal person both small and large lymphocytes are found in the peripheral blood; the former far exceed the latter cell types. Atypical lymphocytes are seen in viral illnesses such as infectious mononucleosis.

MONOCYTES

The monocyte is produced from a committed progenitor cell, the CFU-M, which is derived from the CFU-GM, the common progenitor cell for both the granulocytic and monocytic series. Mature monocyte are released into the circulation, enter the tissues, and there transform into the macrophages of the mononuclear phagocytic system also called reticuloendothelial system. Monocyte and macrophages are more efficient at phagocytizing mycobacterium, fungi, macromolecules, and sensitized erythrocytes and less effective in ingesting pyogenic bacteria. They have a long life span and can synthesize digestive enzymes. Complement components, transferrin, interferon, endogenous pyrogen, lysozyme, colony-stimulating factors, and many other substances can be produced and secreted by the monocyte-macrophage system. The cells in the monocyte-macrophage system assist in the removal of aged or damaged cells, such as red cells and tumor cells, and also interact with lymphocytes in cellular immunity and antibody production.

Monocytosis is often found with chronic infections, such as tuberculosis and sub acute bacterial endocarditis, and in inflammatory diseases, including collagen vascular conditions and inflammatory bowel disease. Other causes are preleukemia, myelocytic leukemias, lymphomas, and the myeloproliferative diseases. 'Histiocytosis X' is indolent form of neoplasia of the mononuclear-phagocytic system. The bone marrow, skin, and lungs are the organs most commonly affected.

Table 16: Some humoral mediators (lymphokines) produced by T- lymphocytes

Lymphokine	Regulatory functions
Interleukin-1	Activates resting T cell Hematopoietic growth factor Mediates inflammatory reactions Endogenous pyrogen
Interleukin-2	Growth factor for activated T cells
Interleukin-3	Growth factor for stem cells
Granulocyte-macrophage stimulating factor (GM-CSF)	Promotes growth of hematopoietic cells of different lineage, Activates mature granulocytes& monocytes Promotes neutrophil growth and function
Granulocyte CSF (G-CSF)	Promotes monocyte growth and function
Monocyte CSF (M-CSF)	Growth factor for activated B cells and resting T cell
Interleukin-4	Enhances cytotoxic T cells
Interleukin -6	Induces differentiation of B cells to plasma cell Promotes megakaryocyte and other hematopoietic cell growth
Interferon (alpha, beta, gamma)	Antiviral activity? I NK activity
Tumor necrosis factor	Suppresses hematopoietic cell growth, Direct cytotoxin to some tumors cells, Stimulates production of lymphokines,

Activates macrophages, Mediates inflammatory reaction
 Mediates septic shock

- Only some of the known functions are included.

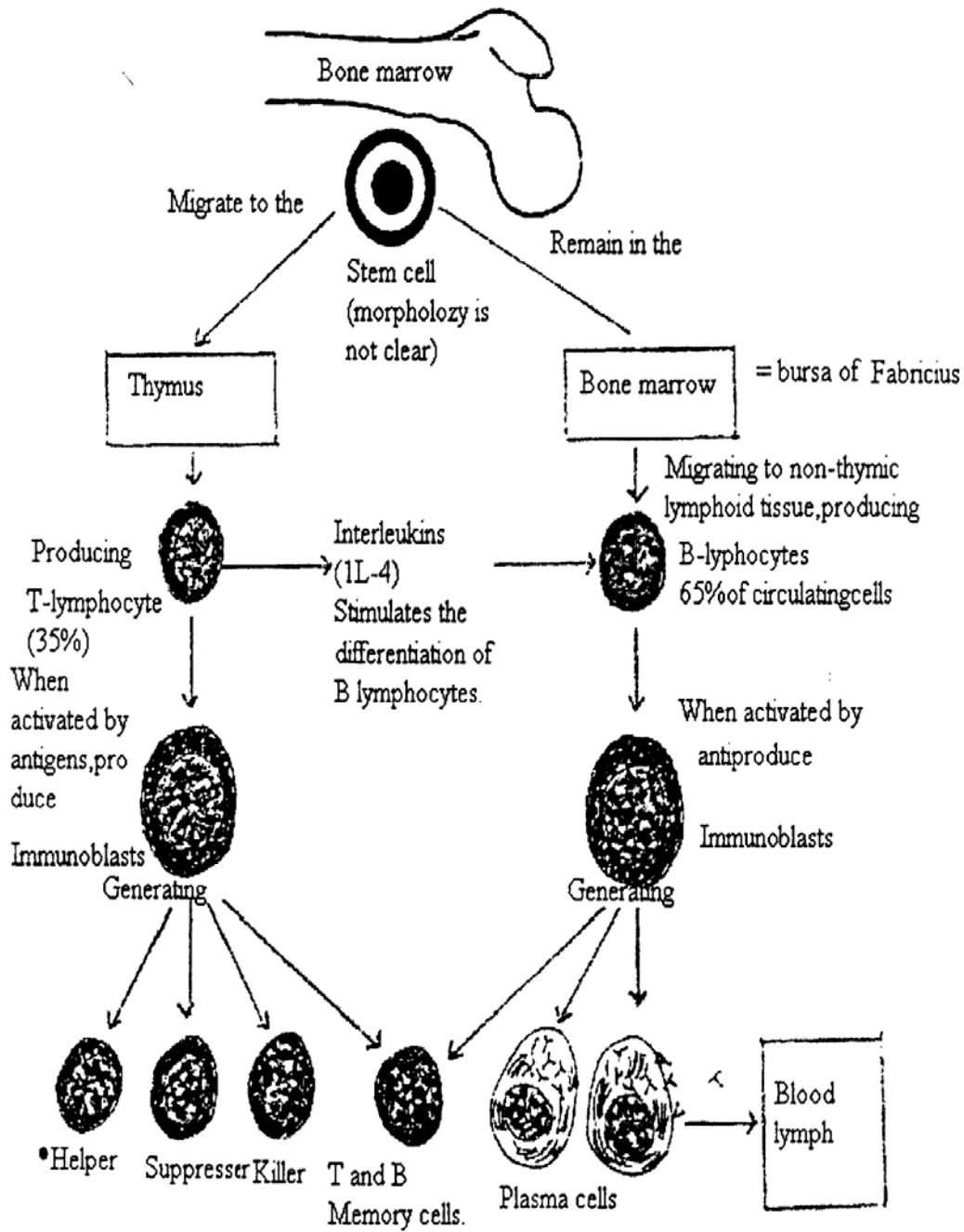

Figure 39. Origin of lymphocytes

THE BODY DEFENCES

The immune system protects against microbes and cancer cells and contributes to tissue repair. The man is exposed to external environment that abounds in external agents that could harm the body if they enter the body. Many such agents are disease causing microbes. The body responds through complex, multiple defense strategy - the 'immune system' - which provides effective protection against attack by foreign agents. The immune defense system either destroys such agents on recognition or neutralizes foreign material that are different to the 'normal self'

Defense against pathogens

removal of worn out cells such as aged erythrocytes and tissue debris i.e. tissue damaged by trauma or disease

recognition and destruction of abnormal or mutant cells that have originated in the body - the immune surveillance is the very crucial internal defense against cancer

Inappropriate immune response may lead to allergy or to 'autoimmune diseases' in which antibodies are produced against 'itself' leading to destruction of a particular type of the body's own cells

Immune system is also responsible for rejection of tissue cells of foreign origin

Pathogenic bacteria and viruses are the major targets of the immune defense system. Bacteria are well equipped with its own machinery necessary for their own growth, multiplication and survival. But, the viruses have only DNA or RNA enclosed by a protein coat; they do not have organelles and therefore, can not synthesize proteins and are unable to carry out metabolism, energy production, and reproduction, unless they invade a host cell. They enter a cell; take over its cellular biochemical facilities for their own purpose. The viral nucleic acids also dictate the host cell/infested cell to produce proteins needed for viral replication.

Leukocytes are the effector cells of the immune defense system. Effective humoral immune response requires macrophage and T cell interactions as well as B cells. Macrophages engulf foreign matter and also contribute to antibody response in different ways: (See figure 40).

they store antigen intracellular and retain processed antigen on their membranes for presentation to lymphocytes;

they process antigen to make them more immunogenic, and they activate helper-T cells, which by their interaction with B cells or by production of soluble factors enhance B cell differentiation, antibody production, and switch from IgM to IgG antibody synthesis

Suppression and modulation of antibody production depends on suppresser-T cells. These cells interact directly with other T cells and elaborate soluble suppressor factors that modulate the humoral immune response. Macrophages also suppress immune response by removing antigens. Loss of T helper or suppressor function may cause immunodeficiency.

T cell Function

The T cells are involved in cellular immunity, resulting from sensitization of lymphocytes following interaction with cell surface antigens. Induction of cell-mediated immunity involves the production of cytotoxic T cells that kills antigen-bearing target cells such as tumor cells or foreign (e.g., grafted) cells with complex interactions with macrophages and subsets of T cells results in proliferation of T cells, production of lymphokines of cell-mediated immunity, and capacity of cytotoxic T cell to kill antigen-bearing target cells on contact

Lymphocytes are responsible for clearing foreign materials (i.e. antigen-bearing cells and microbes) from the body. B cells produce specific antibodies that coats foreign cells or agents, making them susceptible to lymphocytotoxicity or phagocytosis by PMN and macrophages.

Table 17: Functions of Lymphoid tissues

Lymphoid tissue	Function
Bone marrow	Supply of stem cells; Site of maturational processing of B cells
Lymph nodes, tonsils, adenoids, appendix, mucosa-associated lymphoid tissue	Exchange lymphocytes with the lymph resident lymphocytes, produce antibodies and sensitized T cells, remove microbes and other particulate debris from the lymph
Spleen	Exchange lymphocytes with the blood Resident lymphocytes produce antibodies and sensitized T cells, which are released into the blood Resident macrophages, remove microbes, worn out red cells and other particulate debris, from the blood
Thymus	site of maturational processing of T lymphocytes Secretion of hormone thymosin

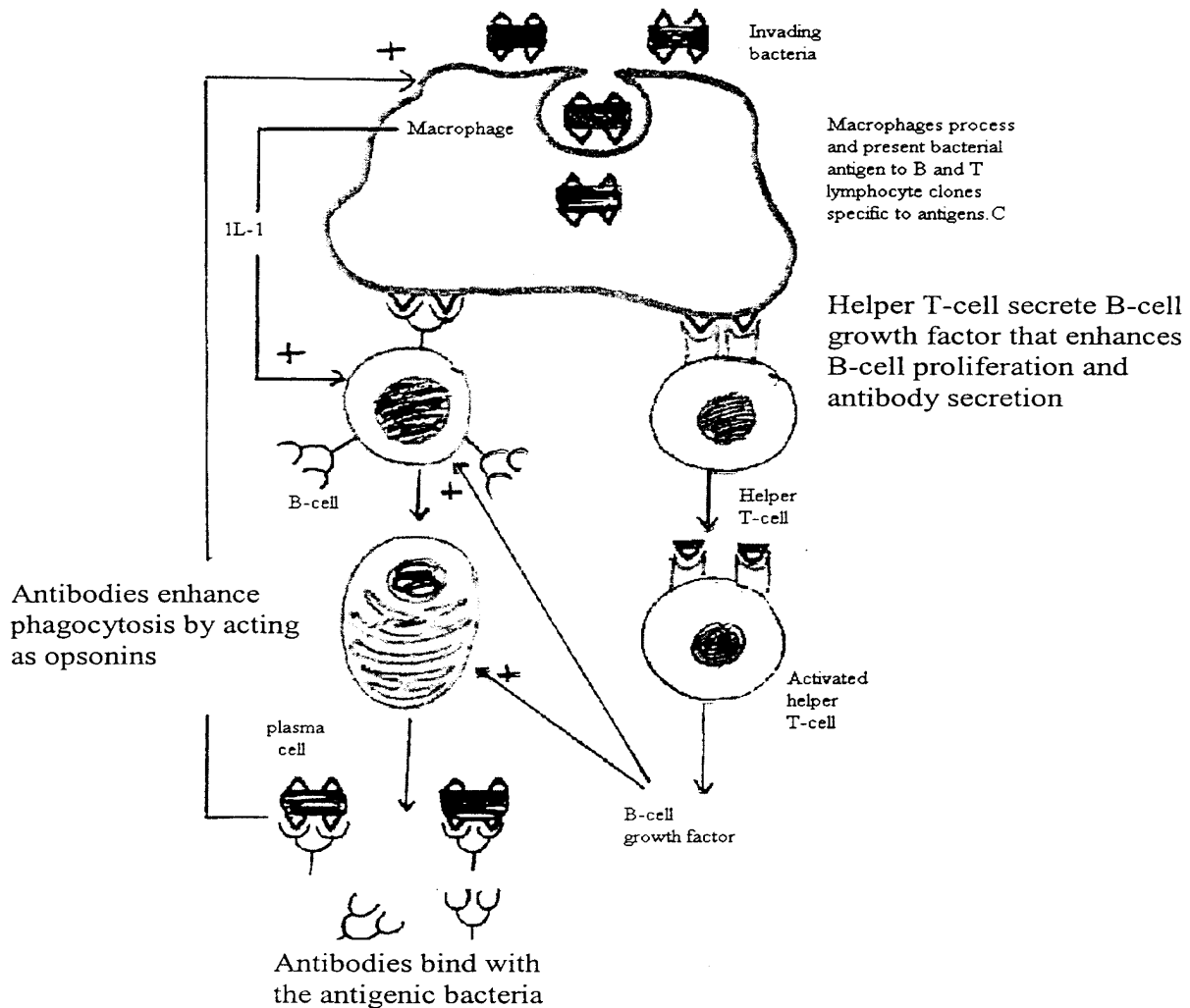

Figure 40. Response of lymphocytes.

Hemostasis

Hemostasis is a collective term for mechanisms, which prevent or minimize blood loss when a blood vessel is opened. Hemostasis is vital because unchecked hemorrhage eventually leads to cardiovascular collapse and death. Hemostasis can be viewed as four separate but interrelated events:

1. Local vasoconstriction
2. Formation of a platelet aggregate (platelet aggregation)
3. Formation of a blood clot

4. Retraction of clot
5. Dissolution of clot

Stages of hemostasis

1 Vasoconstriction

When a blood vessel is injured, its immediate response is to constrict and thereby reduce blood flow. This initial vasoconstriction is due to the local spasm of the smooth muscle in the wall of the blood vessel and to sympathetic reflexes.

2 Platelet aggregations

Platelet aggregation, at the site of injury, serves as a poor but prompt stopper, which tends to stop the bleeding efficiently.

3 Blood Coagulation

The third mechanism for hemostasis is formation of the blood clot. Coagulation is the process by which some of the blood loses its fluid consistency and become a semisolid mass (clot).

4 Clot retraction

Within a few minutes after a clot is formed, it begins to contract and usually expresses most of the fluid from the clot within 20 to 60 minutes.

5 Dissolution of clot (Fibrinolysis)

After hemorrhage has been checked and tissue repair has proceeded, a clot is gradually dissolved by breaking down fibrin into soluble fragments. The enzyme that degrades fibrin is called plasmin.

Blood coagulation

More than 50 important substances that affect blood coagulation have been found in the blood and in the tissues. Some of these substances promote coagulation, called

procoagulants (clotting factors), and the others that inhibit coagulation called **anticoagulants**. Whether blood will coagulate depends on the balance between these two groups of substances. In the blood stream, the anticoagulants normally predominate, so that the blood does not coagulate while it is circulating in the blood vessels. But when a vessel is ruptured, procoagulants in that area of tissue damage become “activated” and override the anticoagulants. Thus, a clot develops.

Clotting factors

Blood clotting is mediated by the sequential activation of a series of coagulation factors, proteins synthesized in the liver that circulate in the plasma in an inactive state. They are referred to by numbers (designated by a Roman numeral) in a sequence based on the order of the discovery of each factor

Factor	Common name	Other names
I	Fibrinogen	
II	Prothrombin	
III	Thromboplastin	
IV	Calcium	
V	Proaccelerin	Labile factor
VII	Proconvertin	Stable factor
VIII	Antihemophilic factor (AHF)	Antihemophilic globulin Antihemophilic factor A
IX	Plasma thromboplastic component	Christmas factor Antihemophilic factor B
X	Stuart power factor	
XI	Plasma thromboplastin antecedent	Antihemophilic factor C
XII	Hageman factor	Glass factor
XIII	Fibrin stabilizing factor	Laki-Lorand factor
HMW-K	High molecular weight kininogen	Fitzgerald factor
Pre-Ka	Prekallikrein	Fletcher factor

Ka	Kallikrein	
PL	Platelet phospholipid	

Stages of blood coagulation

The complex sequence of chemical events that produce clot (fibrin) is divided into three stages

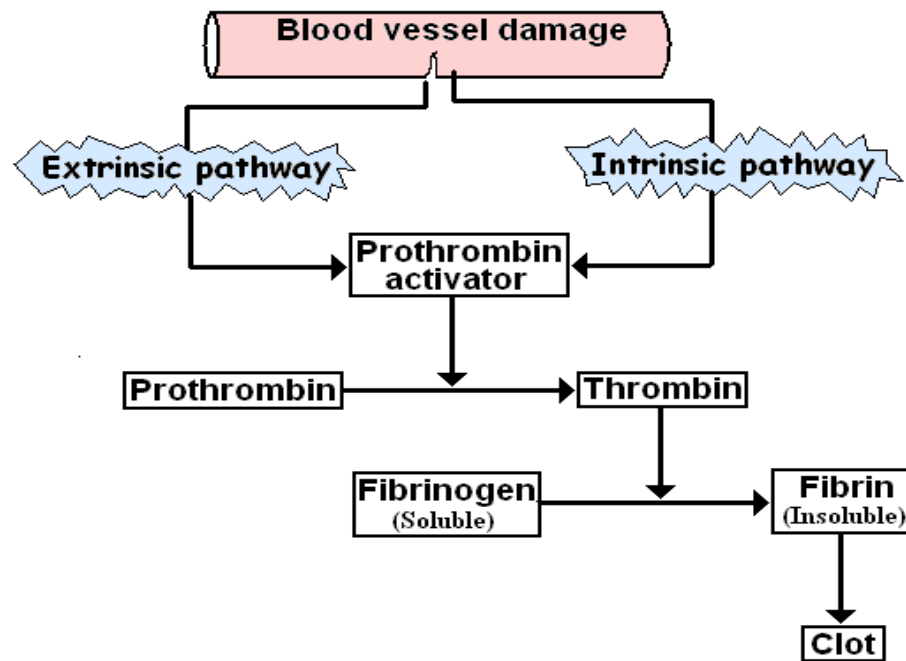

Figure 41: An overview of blood coagulation

Stage I: Formation of prothrombin activator (or prothrombinase)

1 Extrinsic pathway

It begins with trauma to the vascular wall and surrounding tissues.

(a) Release of tissue thromboplastin (Tissue factor/Factor III)

Traumatized tissue releases a complex of several factors called tissue factor or tissue thromboplastin or factor III. This is composed of mainly phospholipids from the membranes of the tissue plus a lipoprotein complex.

(b) Activation of factor X (Stuart factor)

The tissue factor (III) further complexes with factor VII, and in the presence of Ca^{++} , acts enzymatically on factor X to form activated factor X.

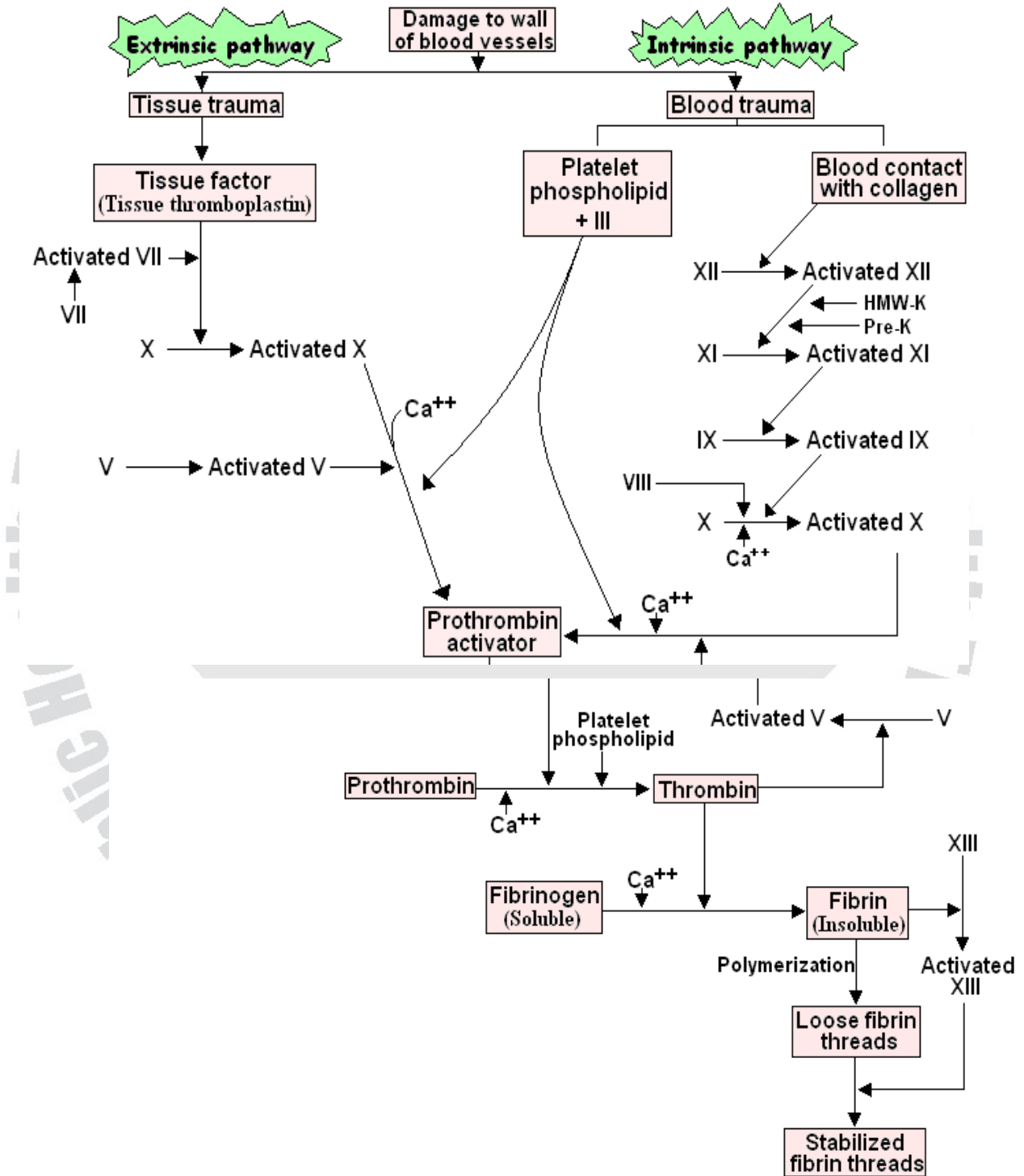

Figure 42: Stages of blood coagulation

(c) Effect of activated factor X (Xa) to form prothrombin activator

The factor Xa combines immediately with tissue phospholipids that are part of tissue factor or combine with factor V to form the complex called prothrombin activator.

2 Intrinsic pathways

It begins in the blood itself, i.e., trauma to the blood or contact with damaged endothelial cells or with collagen. The intrinsic pathway is more complex than the extrinsic pathway.

(a) Activation of factor XII and release of platelet phospholipids

Trauma to the blood or exposure of blood to collagen or to wettable surface such as glass alters the molecular configuration of factor XII. Simultaneously, the blood trauma also damages the platelets and releases phospholipids that contain the lipoprotein called platelet phospholipids

(b) Activation of factor XI

The activated factor XII acts enzymatically on factor XI to activate this factor. This reaction also requires *kininogen* and is accelerated by *prekallikrein*.

(c) Activation of factor IX by activated factor XI

The activated factor XI then acts enzymatically on factor IX to activate this factor also.

(d) Activation of factor X

The activated factor IX, acting in concert with activated factor VIII and with platelet phospholipids from the traumatized platelets, activates factor X.

(d) Action of activated factor X to form prothrombin activator

This step in the intrinsic pathway is same as the last step in the extrinsic pathway. That is, activated factor X combines with factor V and platelet/tissue phospholipids to form the complex called prothrombin activator.

Stage II: Conversion of prothrombin to thrombin

The prothrombin activator, in the presence of sufficient amounts of Ca^{++} , causes conversion of prothrombin to thrombin. Prothrombin is enzymatically split into two

fragments: one inert and the other possessing the properties of thrombin. Initially the conversion of prothrombin proceeds too slowly to produce significant amounts of thrombin needed for coagulation. Thrombin itself, however, increases its own rate of formation by converting proaccelerin (factor V) into accelerin which then accelerates the formation of thrombin.

Stage III: Conversion of fibrinogen to fibrin

- (a) Thrombin acts on fibrinogen to remove four low mol wt peptides from each molecule of fibrinogen, forming a molecule of fibrin monomer. Fibrin is insoluble in plasma.
- (b) Fibrin monomer has the automatic capability to polymerize with other fibrin monomers, thus forming fibrin thread within seconds
- (c) Many fibrin fibers constitute the reticulum of the clot. The clot is composed of a meshwork of fibrin fibers running in all directions and entrapping blood cells, platelets and plasma proteins.

Disorders of hemostasis

I. Excessive bleeding

Excessive bleeding can result from deficiency of any of the many blood-clotting factors. With few exceptions, almost all the blood clotting factors are formed by the liver. Therefore, diseases of the liver such as hepatitis, and cirrhosis can sometimes depress the clotting system.

(a) Vitamin K deficiency

Vitamin K is necessary for the liver formation of five important clotting factors namely prothrombin, factor VII, factor X, and protein C. In absence of vitamin-K, subsequent insufficiency of these coagulation factors in the blood can lead to serious bleeding tendencies.

(b) Hemophilia

Hemophilia is an inability of the blood to properly coagulate due to a genetic lack of a coagulation factor. It occurs almost exclusively in males. Females are carrier of this disorder.

(i) Hemophilia A: involves deficiency of factor VIII. It is genetically transmitted. About 85% of hemophilia is type A.

(ii) Hemophilia B (Christmas disease): It involves the deficiency in factor IX. Clinically it is indistinguishable from hemophilia A

(iii) Hemophilia C: It is not sex linked and results from a deficiency in factor XI.

Symptoms

Hemophilia is characterized by spontaneous or traumatic subcutaneous hemorrhage, blood in urine, and bleeding in the mouth, lips, tongue, and within the joints.

(c) Thrombocytopenia

Thrombocytopenia is characterized by a prolonged bleeding time, with a normal coagulation time. A platelet count of 100,000/cu mm or less is generally considered to constitute thrombocytopenia, although the bleeding tendency does not become evident until the count falls below 40,000/cu mm. The drop in platelets may occur because of either of the following reasons:

(2) Thromboembolic conditions

The pathologic converse to hemostasis is called thrombosis. Thrombosis can be thought of as the formation of blood clot (thrombus) in uninjured vessels, or thrombotic occlusion of a vessel after relatively minor injury. Like hemostatic mechanism, thrombosis also depends on three general components: the vascular wall, platelets, and the coagulation cascade.

(1) Endothelial injury

Endothelial injury is the dominant influence and by itself can lead to thrombosis. It is particularly important in thrombus formation in the heart and arterial circulation, for example, within the cardiac chambers when there has been **endocardial injury** (e.g.,

myocardial infarction, vulvulitis). It is important to note that endothelium does not need to be denuded or physically disrupted to contribute to the development of thrombosis; any perturbation in the dynamic balance of prothrombotic and antithrombotic effects can influence local clotting events. Thus, significant endothelial dysfunction may occur from the hemodynamic stresses of **hypertension**, or **bacterial endotoxins**.

(2) Alterations in normal blood flow

Turbulence contributes to arterial and cardiac thrombosis by causing endothelial injury or dysfunction, as well as by forming countercurrents and local pockets of stasis. Normal blood flow is laminar such that the platelets elements flow centrally in the vessel lumen separated from the endothelium by a slower-moving clear zone of plasma. Stasis and turbulence therefore:

- (a) Disrupt laminar flow and bring platelets into contact with the endothelium
- (b) Prevent dilution of activated clotting factors by fresh-flowing blood
- (c) Retard the inflow of clotting inhibitors and permit the build-up of thrombi
- (d) Promote endothelial cell activation.

(3) Hypercoagulability

Hypercoagulability generally contributes less frequently to thrombotic states but is nevertheless component in the equation. It is loosely defined as any alteration of the coagulation pathways that predisposes thrombosis, and it can be divided into primary (genetic) and secondary (acquired) disorders.

(a) Inherited: Of the inherited causes of hypercoagulability, *mutations in the factor V gene* and prothrombin gene are the most common. The characteristic alteration is a mutant factor Va that cannot be inactivated by protein C; as a result, an important antithrombotic counter-regulatory pathway is lost.

(b) Inherited: Among acquired causes, hypercoagulability may be related to increased hepatic synthesis of coagulation factors and reduced synthesis of antithrombin III. *Use of oral contraceptives* and the hyperestrogenic state of *pregnancy* are some common examples of this category.

Disseminated intravascular coagulation

It is characterized by activation of the coagulation sequence, leading to formation of thrombi throughout the microcirculation. As a consequence of the widespread thromboses, there is consumption of platelets and coagulation factors and, secondarily, activation of fibrinolysis

THE HEART

INTRODUCTION

Blood carrying nutrients and oxygen reaches the tissues through a system of vessels of different diameters, elasticity, capacity, and permeability. The systemic circulation, which supplies all the tissues, is a high-resistance system with a large pressure difference between the arteries and veins. The arteries are highly elastic and muscular; they distribute blood to the smaller arterioles and ultimately to the network of capillaries, where exchange of fluid, small molecules and nutrients occurs across the thin walls. Blood returns to the heart through the venules, wide, thin walled veins.

Human heart is a four chambered pump, well adapted to separation of oxygen rich and oxygen poor blood handled by left and the right side of the heart respectively. Thin wall atria receive blood, which reaches into thick-walled ventricles that pump blood into systemic and pulmonary circuits through great vessels.

The pulmonary circulation is a low-pressure, low-resistance system handling the same amount of blood at the same time as systemic circulation to keep the same amount of blood in the right and left side of the heart. The left ventricle is more muscular and heavier than the right ventricle, which pumps against the low resistance of the pulmonary circulation; the left pumps against the high resistance of the systemic circulation.

The mean systemic arterial pressure is 90-100 mmHg, whereas the mean pulmonary pressure is only 8 to 24 mm Hg. The low arterial pulmonary pressure eliminates the need for much supporting tissue in the lungs so that it can have millions of thin-walled

alveoli. And highly specialized pulmonary capillaries, facilitating the rapid exchange of gases between the blood and alveolar air.

Functional anatomy of the heart

The adult heart is enclosed in a double walled sac, the pericardium that attaches it to the mediastinum. The apex is rounded and formed by the left ventricle and located behind the sixth rib, about 3 inches to the left of the midline of the body.

The myocardium is about half of the tissue of the heart, the other half is connective tissue, the fibrous skeleton, valves, tendons, blood vessels, lymphatics and nerves. The chambers of the heart are lined by endothelium, a thin smooth layer of cells. The main conducting system of the heart is made up of modified cardiac muscle fibers situated in the interventricular septum and radiating out into the walls of the ventricles. This tissue has lost contractile elements and become specialized for the rapid conduction of electrical impulses. Two nodes/areas, the sinoatrial node, and the atrioventricular node discharge rhythmic impulses that are transmitted through the heart. In humans, the heart and vessels form a closed circulation that assures all the circulating blood returning to the heart. The fluid and proteins that leak out in the tissues are brought back to the blood through the lymphatic circulation.

Blood Vessels of the Heart: Heart has its delivery system for the cardiac muscle fibers; it cannot be nourished by blood flowing through its chambers but are supplied by a specialized 'coronary circulation'.

Heart Valves: The blood flow through the heart is from the large veins into the atria, from the atria to the ventricles, and from the ventricles into elastic, thick-walled arteries. This one-way/unidirectional flow is achieved through the atrioventricular valves that guard entrance to the ventricles and the semilunar valves that guard the arterial openings. These valves are regulated by pressure gradient across them (see figure 43).

Atrioventricular (AV) Valves

Tricuspid is between the right atrium and right ventricle, getting its name from three cusps/ flaps around the opening to the ventricle. The AV valve is the bicuspid or mitral

valve. Both valves are fastened to small conical 'papillary muscles, on the ventricular walls through several tendinous, the 'chordae tendinae'. The papillary muscle and the ventricles contract at the same time to prevent valve's excursion into the atrium.

Aortic and Pulmonary (Semilunar) Valves

Both large arteries are guarded by the semilunar valves at the exit of the two ventricles. Each valve is made up of three half-moon cusps; the cusps are thin but very strong, fitting very closely, enabling them to withstand very high pressures that cause the valves to open and to snap shut during ventricular contraction and at the end of systole. The semilunar valves close during the ventricular relaxation (diastole).

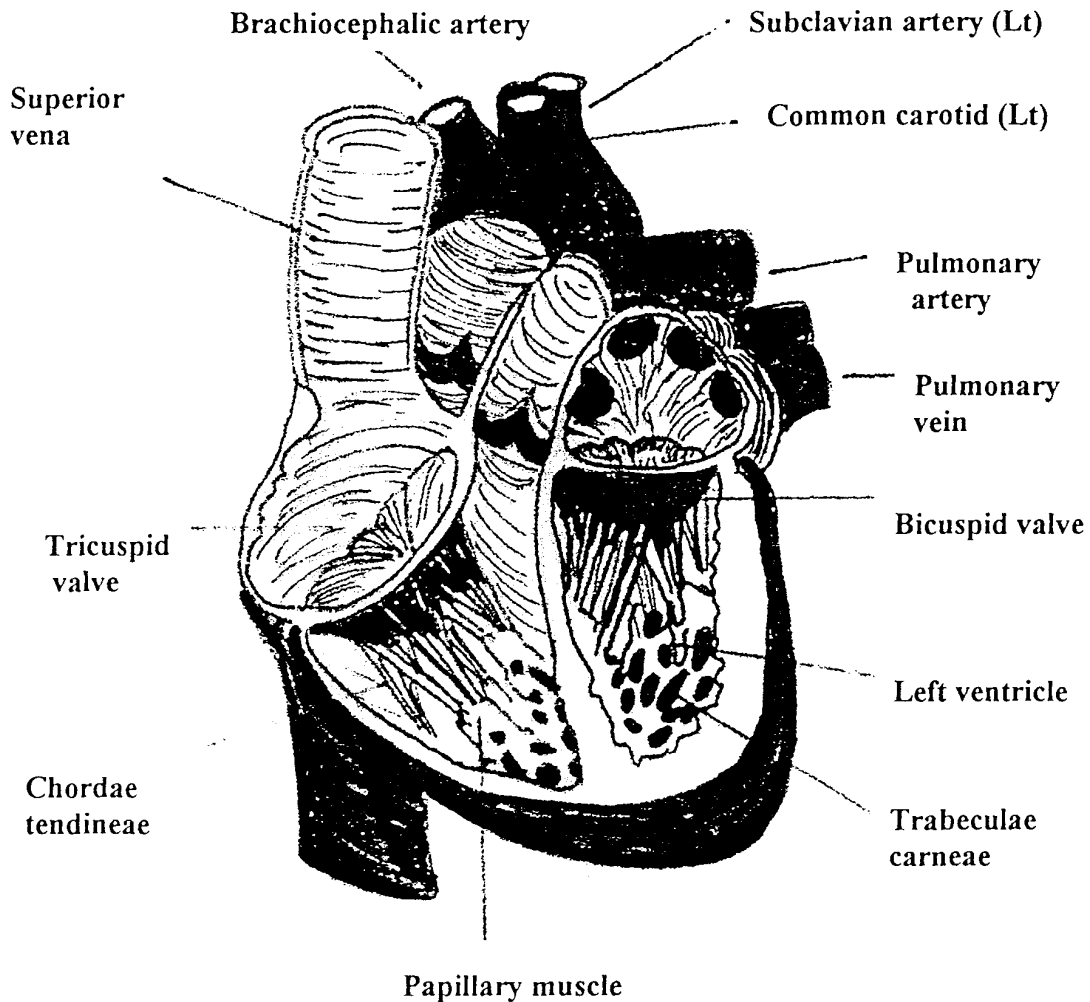
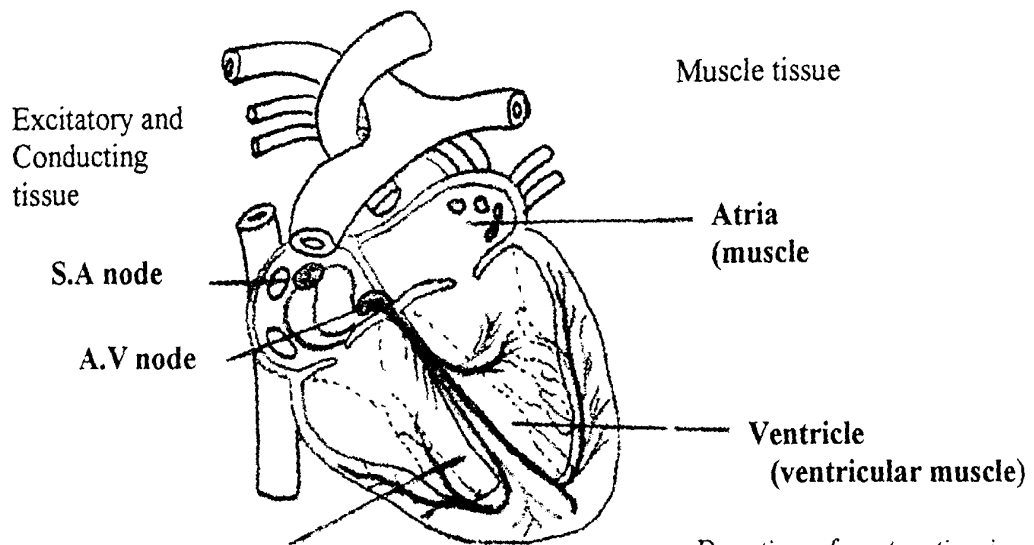

Figure 43. Shows heart chambers and valves.

Pacemaker and Conducting System (see fig. 44)

The heart beat is initiated by the pacemaker (SA Node) lying between the superior vena cava and the right atrium. The rhythmic depolarizations generated by the SA node are conducted through the atria to less rapidly firing AV node lying in the right atrium, close to the interventricular septum. After a short delay in the AV node, the cardiac impulses are conducted through the main conducting system of the heart, for the rapid conduction of electrical impulses. This is interventricular area conduction cells that radiate into the muscle wall of the ventricles.

Myocardium: The atrial myocardium is comprised of two thin muscular sheaths at right angles to each other, permitting the atria to act as receiving and pumping chambers. The ventricular myocardium is divided into spiral muscles and deep constrictor muscles, that looks like a sandglass; the result of complex twisting contraction is the direction of main stream of blood towards the openings of great vessels. The myocardium has specialized areas of sarcolemma called 'intercalated disk', that are cell-to cell junctions close enough to form a gap junction; these gap junctions offer very low electrical resistance, causing the myocardium to respond as 'functional syncytium' and not anatomical. There is no impediment to the passage of an action potential; therefore the excitation spreads to all fibers of a chamber.



Rhythmicity property and rapid conduction of the excitation throughout the heart

Duration of contraction is similar to skeletal muscle, but the duration is longer

THE SYNCYTIAL NATURE OF CARDIAC MUSCLE

Myofibrils containing actin and myosin

*Lattice work of muscle fibers.
(80 μm long; 15 μm diameter)*

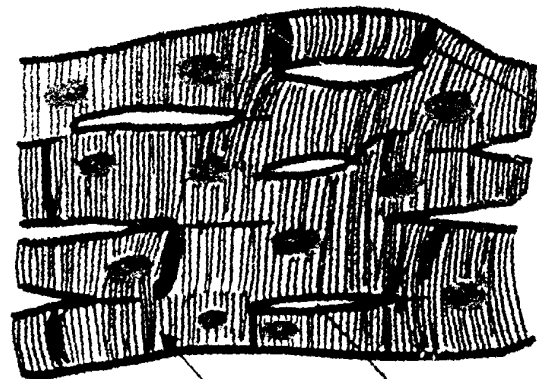

Intercalated

(Cell membranes making junctions between cells)

Endomysium

Striations

Space between the cells containing Fibroblast, collagen Reticulum fibers

Figure.44 shows cardiac muscle cells

Structure of cardiac muscle.

Cardiac muscle has more mitochondria and rich myoglobin than most skeletal muscles. Myoglobin stores oxygen and facilitates its transport from the sarcolemma to the mitochondria.

The transverse tubular system (T system) penetrates into the substance of the muscle fiber and also runs longitudinally within the fiber. The T system is in contact with the ECF space, and permits passage of large molecules. The sarcoplasmic reticulum is adjacent to the T-system. The T-system is associated with the conduction of the action potential; it depolarizes the SR causing the release of ionic calcium that initiates the muscle contraction.

Mechanism of Contraction

The sliding of the contractile elements is brought about through the formation and breaking of 'cross-bridges' between the actin molecules and the heads of the myosin molecules. This process is dependent on rapid changes in intracellular ionic calcium levels. An action potential along the sarcoplasmic reticulum results in the influx of extracellular ionic calcium through the T-system, and the release of calcium from the SR. Calcium binds with troponin, which results in the displacement of the long tropomyosin that has been blocking the binding sites for myosin on actin.

Tropomyosin and troponin are known as regulatory proteins. Actin and myosin are the contractile proteins. ATP provides the energy required for these mechanical actions. Relaxation needs the rapid removal of Ca^{++} from the myofilament environment. The SR uses ATP for actively transporting calcium back into its cisternae and channels. The fall in cytosolic Ca^{++} affects the troponin-tropomyosin complex, pulling tropomyosin molecules back into their blocking position, opening the cross-bridges, and permitting the thin actin filaments to slide apart as the muscle relaxes.

INNERVATION OF THE HEART

The heart gets nerve supply from both the sympathetic & the parasympathetic system that exerts a continuous but changing tonic influence on it. They affect the performance

of the heart by change in heart rate, contractility, refractory period, & excitability and conductivity of the specialized conduction tissue through the heart. The parasympathetic vagi innervate the SA & AV nodes & the atria, & innervations to the ventricles. Sympathetic from the stellate & caudal sympathetic ganglia, innervate the same structures like vagi, with a particularly rich innervations of the ventricles.

Inotropic and Chronotropic Characteristics of the Heart

The force contraction refers to inotropic state and changes in the heart rate refer to the chronotropic characteristic. Autonomic actions of the nerves are affected by changes in blood temperature, pH, & the amount of blood returning to the heart. Both characteristics are sensitive to many drugs, which can alter the effects of nerves activity.

Parasympathetic stimulation

- Acetylcholine has a marked negative inotropic effect on myocardium decreasing contractility.
- ACh also reduces heart rate and makes heart more refractory, and slows conduction through the heart

Sympathetic Stimulation

- Norepinephrine and epinephrine increase myocardial contractility, accelerates heart rate, decrease the refractory period, and shortens the conduction time through the heart.
- Improves synchronous contraction and relaxation of each heart chamber so that maximum ejection is achieved

Characteristics of Cardiac Muscle

The inherent contractility of cardiac muscle is much marked. Striated muscles contract most rapidly and smooth muscle contraction is long and slow.

Inherent Rhythmicity

The heart cells can be divided into “leader-cells” and “follower-cells”. The SA node has the highest rhythmicity (110-120); AV node (60); myocardium (20-40).

All or None Principle

The strength of contraction is not dependent on the strength of the stimulus. Cardiac muscle responds to an adequate stimulus with a maximum strength. This is **all- or-none** principle. Although the heart responds with maximum contraction, the maximum varies with the physiological conditions. The degree of the heart’s filling with blood, hormones, changes in the ionic concentrations, temperature changes - all modify both the rate and the strength of contraction.

Refractory Period

The cardiac muscle has much longer refractory period than that of nerve or skeletal muscle. The absolute refractory period of the heart is about 0.25 second during which it is completely unresponsive to any additional stimulation but can be stimulated by a very strong stimulus during relative refractory period of 0.05 sec. The long absolute refractory period of the heart prevents it from going into sustained contraction, or tetanus, and thus ensures that there is an adequate diastolic period during which the heart fills with blood.

Effect of Temperature

It is up to a certain point the rate and strength of heart beat are increased by a rise in body temperature. This optimum temperature for enzymatic actions in warm-blooded animals is about 40°C. Considerable rise in temperature above this destroys enzymes and structural proteins. Cooling slows the heart, decreases the contractile strengths as the chemical reactions are slowed. Temperature also affects both contractility and the pacemaker (SA Node) activity. Heart rate increases about 10 beats per minute for every one- degree rise in Celsius temperature. Cooling slows the pacemaker and severe cooling is used for some surgical operations.

Effect of Ions

The most important cations are calcium, potassium, and sodium.

- In Hypokalemia, the PR interval is lengthened, the ST segment is depressed, the T wave is inverted, and a prominent 'U' wave is recorded in the ECG/EKG
- Hyperkalemia presents as very tall, slender peaked T wave
- Further elevation of plasma potassium result in ventricular tachycardia and ventricular fibrillation.
- Hyperkalemia decreases resting membrane potential, the intensity of the action potential also decreases, which makes the contraction of the heart weaker.
- Hypokalemia prolongs the relative refractory period; there is increased incidence of bradycardia, and high risk of arrhythmias
- Hypercalcemia results in increased myocardial contractility.

Contractility

Myocardial contractility is affected by the following three factors:

1. Contractile state
2. Stretch or preload
3. after load

Specialized cells or conducting cells:

Sinoatrial Node (SA node): Pacemaker of the Heart

The SA node has most rapidly discharging cells. (See figure 45 & 46). The rhythmic excitation (Depolarization) begins in the SA Node; it is responsible for the subsequent excitation, and consequently contraction, of the atria and ventricles, in that order. The SA node discharges at a heart rate 72 per minute, resulting in heart rate of 72 beats / min. AV node discharges 60 times /min; Atria= 40 times/min: ventricles 10 - 20 times/ min.

Atrial Bundles

Action potentials generated in the SA node rapidly travels through the atria, at about 0.3 meters /sec & conducted very rapidly to the AV node 0.5 meter /sec. Atrial fibers form the atrial bundles; bundle connecting the two nodes is the internodal pathway.

Atrioventricular Node

Its fibers conduct very slowly, about 0.2 & 0.5 meters/second. This delay in conduction creates efficiency of the heart, since the delay allows time for the atria to empty before ventricular depolarization and contraction begins. (See figure 46 & 47).

Bundle of His

This is made up of specialized cardiac fibers, the purkinje fibers that originate in the node and form a bundle in the septum separating the two ventricles.

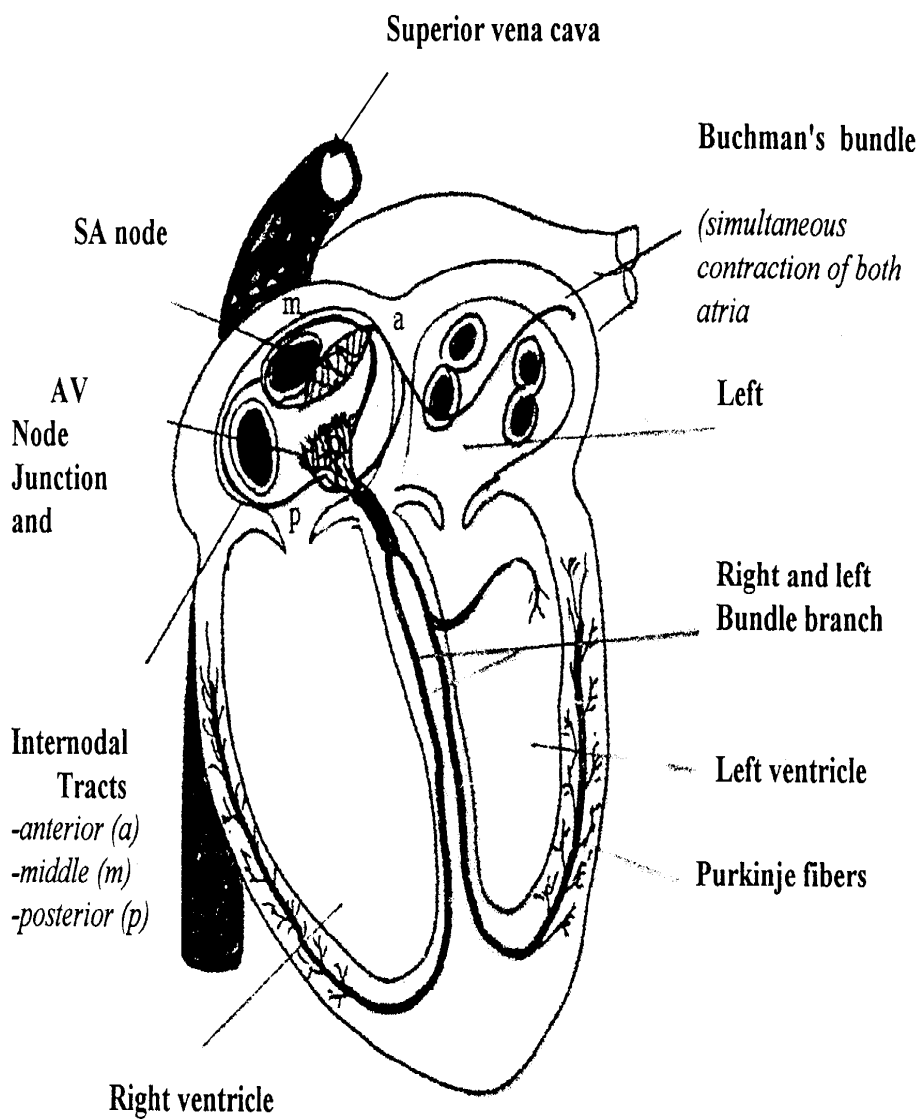
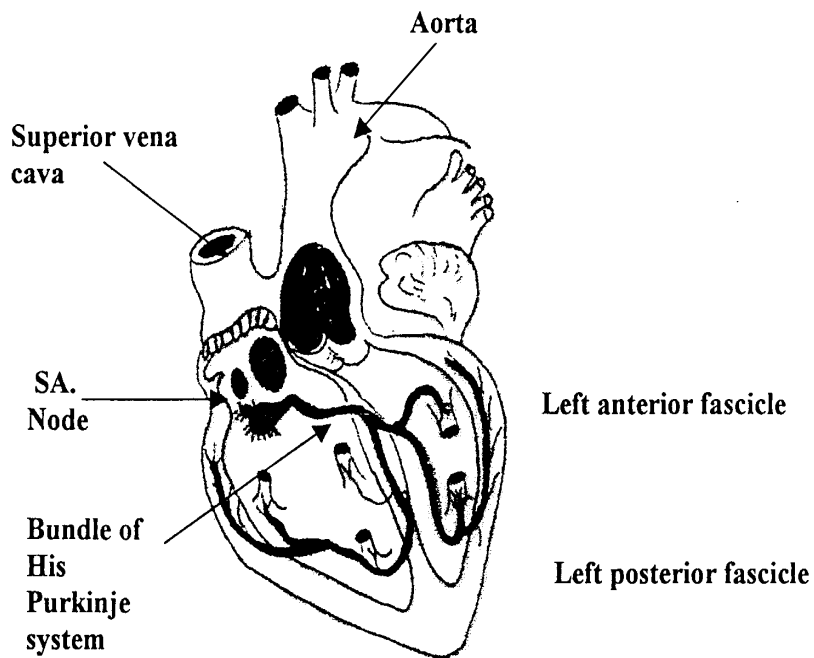

Figure 45. The nodal tissues of the heart.



ACTION POTENTIAL

Typical transmembrane action potentials for SA and AV nodes, other parts of the conducting system, and the atrial and ventricles are shown along with the ECG

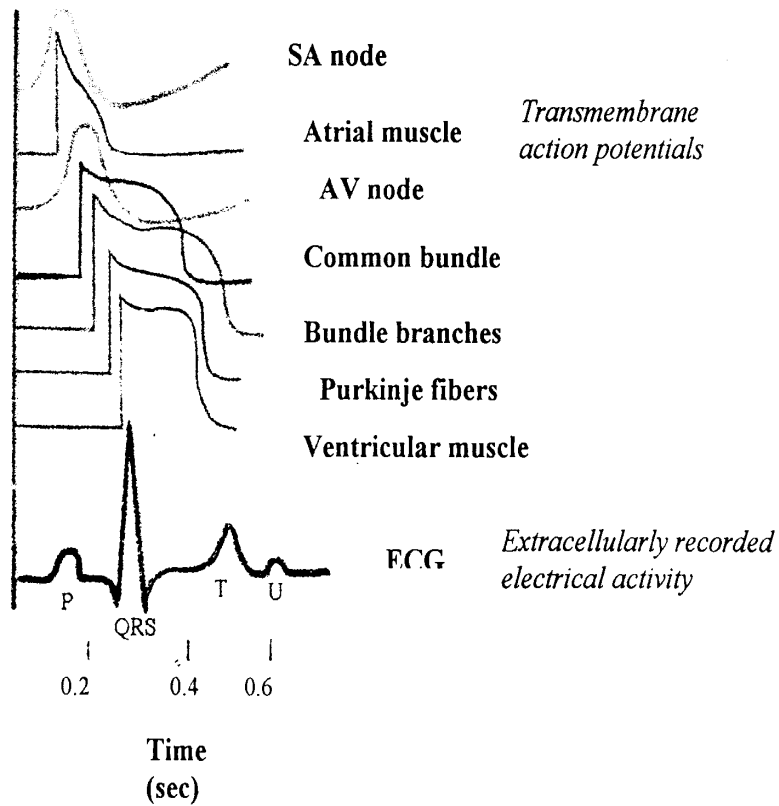

Figure 46. Conducting systems of the heart

The Electrocardiogram (ECG or EKG)

The electrical activity of the heart produces potentials at body surfaces that can be recorded by placing surface electrodes, as the EKG. (See figure 47). The electric currents from the heart pass into the surrounding tissues and spread to the surface of the body. The cardiac activity is obtained in the standard ECG by using 12 leads, six of which are limb leads and six are chest leads.

Clinical application of ECG

ECG is a non-invasive, inexpensive, and highly versatile test. By analyzing the details of these potential fluctuations, the physicians gain valuable insight concerning:

- The anatomical orientation of the heart
- Relative sizes of its chambers
- A variety of disturbances of rhythm of conduction
- The extent, location, and progress of ischemic damage to the myocardium
- The effects of altered electrolyte concentrations (e.g., hyperkalemia)
- The influence of certain drugs (notably digitalis and its derivatives)

Analysis of the EKG:

1. The 'P' wave

- Represents atrial depolarization & precedes contraction of the atria
- Its duration indicates the time taken for the depolarization to spread through the atria from the SA node (0.08-0.10 sec).

2. The QRS Complex: consists of 'Q', 'R' & the 'S' waves.

- The complex represents ventricular depolarization preceding ventricular contraction.
- Duration: 0.06 to 0.09 second.
- It has higher amplitude than that of 'P' wave

- It has a shorter duration than the 'P' wave, because depolarization spreads very quickly through the purkinje network.
- The large QRS complex completely masks obliterates any record of atrial repolarization, which occurs at this time.
- Prolongation of QRS complex: indicates delayed conduction through the ventricles, is often caused by ventricular hypertrophy, with its increased muscle mass, and also increases the voltage of the QRS complex. Another cause is conduction block of one of the bundle branches.

PR interval: it is an important parameter of the ECG; it is the time taken from the start of depolarization of the atria to the beginning of ventricular depolarization. Normal interval 0.12- 0.20 sec.

The S-T segment

- The S-T Segment is the flat base line/isoelectric line between the QRS complex and the T-wave.
- This segment represents the time during which all regions of the ventricles are still depolarized and presents the long plateau phase of the cardiac action potential.
- Has a duration of about 0.09 second
- Is distorted in myocardial infarction

The 'T' wave

- Represents ventricular repolarization.
- Its duration is longer than that of the QRS complex because repolarization is not synchronous throughout the ventricles like depolarization which is more synchronous.

The QT Interval coincides with the beginning and the end of ventricular systole. It lasts about 0.30 second, a time that varies with the heart rate.

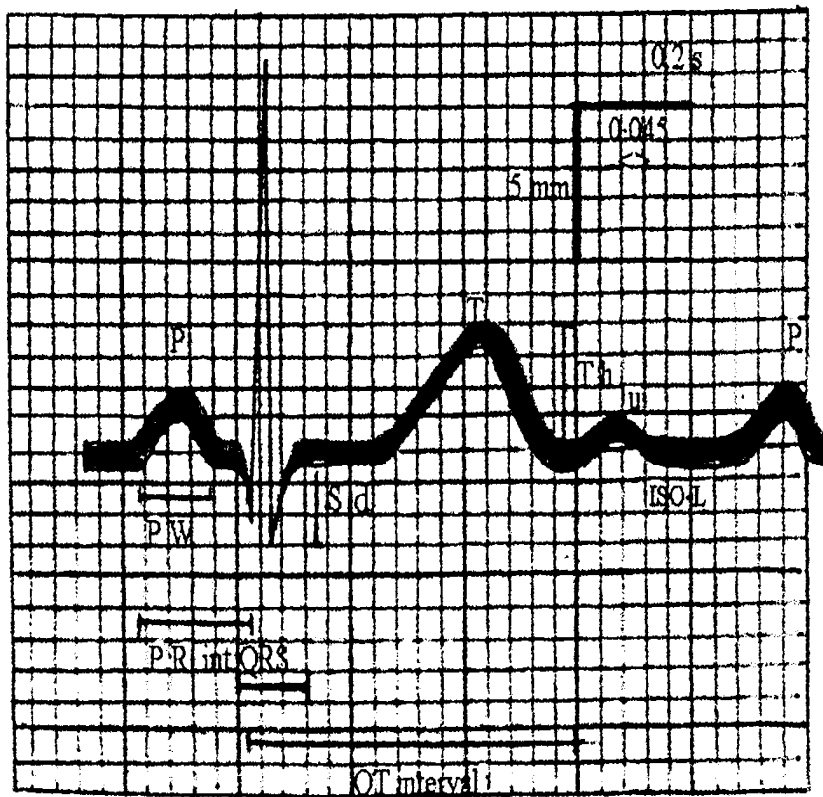

No current is being produced by the heart at the T-P segment.

Figure 47. Normal Electrocardiogram

Interpretation of ECG

An ECG provides information on heart rate and rhythm, conduction velocity, and even the condition of tissues

Within the heart. The interpretation of an ECG begins with the following questions:

(1) What is heart rate?

Heart rate is normally timed from the beginning of one P wave to the beginning of the next P wave, or from

Peak to peak of the QRS complexes. A faster rate is called tachycardia, and a slower rate is called bradycardia.

(2) Does the heartbeat occur at regular interval?

An irregular rhythm, or arrhythmia, can result from a benign extra beat or from more serious conditions such as atrial fibrillation, in which the SA node has lost control of pace making.

(3) Is the voltage normal?

Normally, the voltages in the three standard bipolar limb leads, as measured from the peak of the R wave to the bottom of the S wave, vary between 0.5mV and 2.0mV, with lead III usually recording the lowest and

Lead II, the highest. However, these relations are not invariably true even in the normal heart. In general,

When the sum of the voltages of all the QRS complexes of the three standard leads is greater than 4mV, one considers that the patient has a high-voltage ECG.

High-voltage ECG is common in **ventricular hypertrophy**. Low-voltage ECG is found in cardiac **myopathies**, **fluid in the pericardium**, **pulmonary emphysema** etc.

(4) Relationship of various waves

After determining the heart rate and rhythm, and voltage of ECG, the next stage in analyzing an ECG is to look at the relationship of the various waves. Does a QRS complex follow each P wave and is the PR segment constant in length? If not, a problem with conduction of signals through the AV node may exist. In **heart block**,

action potentials from the SA node sometimes fail to be transmitted through the AV node to the ventricles.

In these conditions, one or more P waves may occur without initiating a QRS complex.

(5) Alterations in the shape or duration of various waves or segments

The more difficult aspects of interpreting an ECG include looking for subtle changes such as

alterations in the shape or duration of various waves or segments.

The cardiac cycle

The cardiac cycle is the period from the end of one heart contraction (Systole) and relaxation (diastole) to the end of next systole and diastole. (See figure 48). Cardiac contraction is preceded by electrical changes initiated by the pacemaker of the heart, the sino-atrial node. The contraction of the heart generates pressures within the heart that regulates the opening and closing of the valves and consequently directs the blood flow through the heart and the arteries. Electrical changes are recorded on the electrocardiogram, and the heart sounds are recorded on a phonocardiogram. Similar events occur in the right and left side of the heart, but ventricular and atrial pressures are lower in the right heart. At a heart rate of 75 beats/min, the total cycle time is about 800 milliseconds, a systolic time of 250 - 300 msec, a diastolic time of 500 - 550 msec.

Systole and diastole

Systole is contraction of the heart, relaxation is diastole. Each of the four chambers of the heart contract and relax rhythmically, filling with blood during diastole, ejecting the blood during systole. The right and left heart contract and relax simultaneously, ejecting equal blood volume at the same time, but with different pressures.

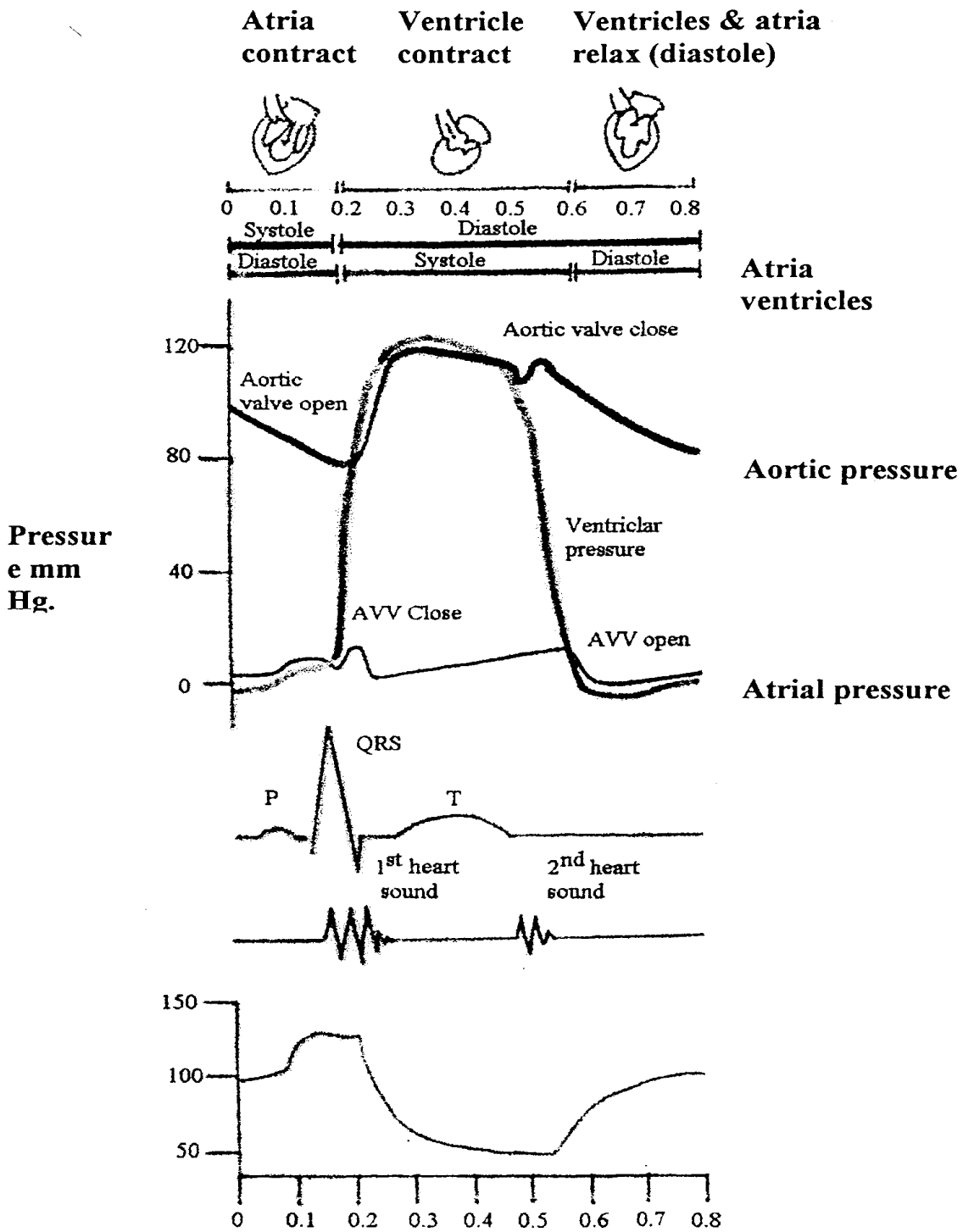

Figure 48. The cardiac cycle

Atrial cycle

The atria have a minor role during normal resting conditions but contribute significantly to the filling of the ventricles during exercise. The thin-walled atria receive blood continuously from the superior and inferior vena cavae. 70% of ventricular blood volume flows directly through the opened atrioventricular valves into the ventricles. Atrial systole initiated by depolarization occurs late in ventricular diastole and adds 30% to total ventricular filling. Pressure in left atria reaches 7 - 8 mmHg, that in the right atrium to 4 - 6 mm Hg, during atrial contraction. Just prior to ventricular systole, rising pressure in the ventricles closes the atrioventricular valves (AVV). During this AVV closure, the atria continue to fill with blood from great veins, resulting in an increase in atrial pressure.

Ventricular cycle

At the end of ventricular systole, the ventricular pressure falls abruptly when blood is ejected into the aorta and pulmonary artery. At this stage, arterial pressures are higher than ventricular, snapping closed the semilunar valves. For a period of 0.03 - 0.06 seconds, AV valves remain closed, and ventricles begin relaxation. This phase of ventricular relaxation without volume change is called isovolumetric relaxation period. Ventricular pressure falls below atrial pressure, causing AV valves to open again. Opening of the valves results in rapid blood flow into the ventricles. This is the passive rapid filling phase of ventricular diastole. In the later diastole phase, the filling of the ventricles is aided by atrial contraction - active rapid filling phase. At the end of diastole, ventricles contain about 120 ml of blood - known as end - diastolic volume (EDV) in each ventricle. Ventricular systole begins with depolarization of the ventricles. The high ventricular pressure closes the AV valves producing the first heart sound. There is a period when ventricles are contracting, there is no change in ventricular volume and is known as isovolumetric contraction period (0.02 to 0.03 second).

During this phase of contraction, the pressure rises in both ventricles, forcing open the semilunar valve. About two-thirds of the ventricular blood is rapidly ejected into the arteries in the first third of systole, the rest of the blood is ejected slowly during the

second two-thirds of systole. The volume of blood remaining in each ventricle at the end of systole is the end-systolic volume, about 50 ml of blood. Therefore the stroke volume of normal heart in resting conditions is $120 - 50 = 70$ ml.

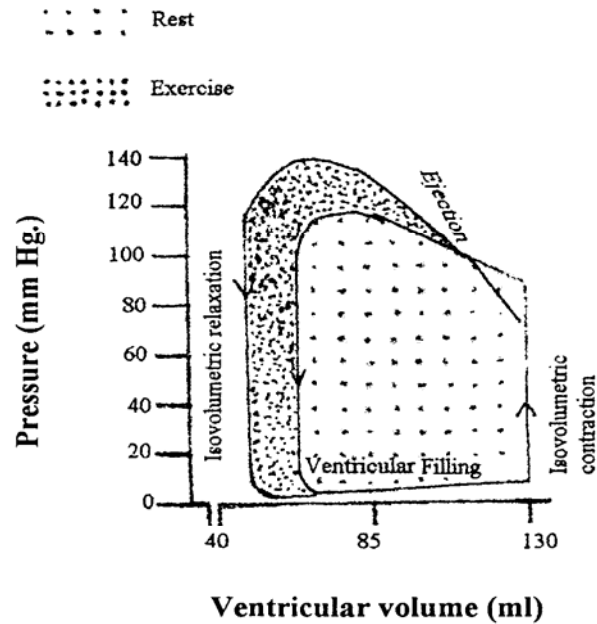

Figure 49. Pressure – Volume Loop of the Cardiac Cycles at Rest and During Exercise.

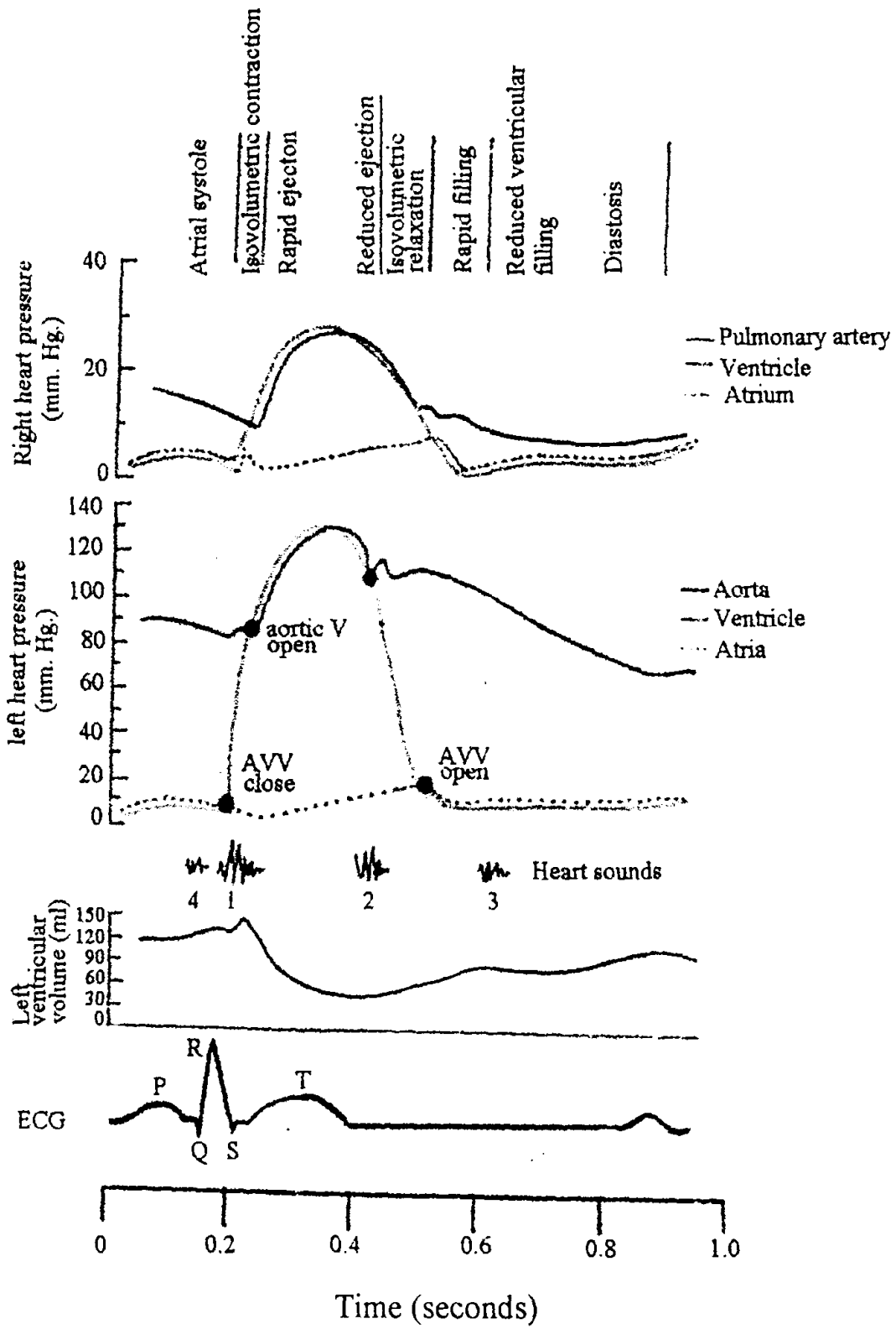

Figure 50. Correlation of events in the cardiac cycle

Heart sounds

During each cardiac cycle, four heart sounds are generated. In a normal heart, however, only the first two (First heart sound and second heart sound) are loud enough to be heard by listening through a stethoscope.

When listening to the heart with a stethoscope, one does not hear the opening of the valves, for this is a relatively slowly developing process that makes no noise. However, when the valves close, the vanes of the valves and the surrounding fluids vibrate under the influence of the sudden pressure differentials that develop, giving off sound that travels in all directions through the chest. Two heart sounds are normally clearly Audible per beat, the first and second heart sounds. They are usually represented as ***lubb-dupp*** followed by a Pause. The heart sounds can be recorded by a microphone placed on the precordium, and a tracing of the sound is called a ***phonocardiogram***. Just as the ECG gives important information about the electrical operation of the heart, heart sounds provide valuable information about its ***mechanical operation***.

Anatomical location for best hearing the heart sounds

Mitral valve: The mitral valve is best heard in the mid-clavicular line of the 4th-5th left intercostals space.

Tricuspid valve: The tricuspid valve in the 5th interspace at the left sternal edge.

Aortic valve: The aortic valve in the 2nd interspace at the right sternal edge.

Pulmonary valve: The pulmonary valve in the 2nd interspace at the left sternal edge.

Types of heart sounds

First heart sound (S1)

Heard by a stethoscope

Frequency: 100Hz

Duration: 0.14s.

Cause: Closure of the tricuspid and mitral valves.

Second heart sound (S2)

Heard by a stethoscope

Frequency: 100Hz

Duration: 0.11s.

Cause: Closure of the semilunar valves.

Third heart sounds (S3)

Generally, not heard by a stethoscope

Recorded by phonocardiogram only one-third to one half of all persons

Very low frequency

Cause: Rushing of blood into the relaxing ventricles during early diastole

Fourth heart sound (S4) or atrial sound

Generally not heard by a stethoscope

Recorded by phonocardiogram only one-fourth of all persons

Very low frequency (about 20 Hz)

Cause: Rushing of blood into the aorta and pulmonary artery from the contracting ventricles.

Disorders of heart sound (Heart murmurs)

Just as the ECG gives important information about the electrical operation of the heart, heart sounds provide valuable information about its mechanical operation. A heart murmur is an abnormal sound that consists of a flow noise that is heard before, between, or after the lubb-dupp or that may mask the normal heart sounds.

Mitral stenosis: Narrowing of the mitral valve by scar formation or a congenital defect

Mitral insufficiency: Back flow or regurgitation of blood from the left ventricle into the atrium due to a damaged mitral valve or ruptured chordae tendinae.

Aortic stenosis: Narrowing of the aortic semilunar valve.

Aortic insufficiency: Backflow of blood from the aorta into the left ventricle.

Mitral valve prolapse: An inherited disorder in which a portion of mitral valve is pushed back too far (Prolapsed) during ventricular systole. Mitral valve prolapse often does not pose a serious threat. In fact, it is found up to 10% of otherwise healthy young persons.

Rheumatic fever: Damage of the bicuspid and aortic semilunar valves.

2nd sound:

Duration: 0.12s

Frequency: 50 Hz.

*Loud & Sharp
(↑DBP)*

Tricuspid valve

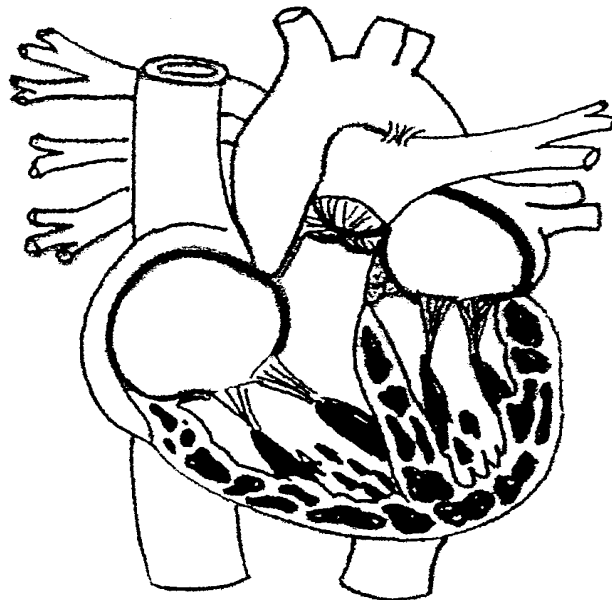

Pulmonary and aortic valve

(fast velocity of blood ejection)

mitral valve

1st sound:

Duration: 0.15s

Frequency: 24.45 Hz

Soft at slow heart rate

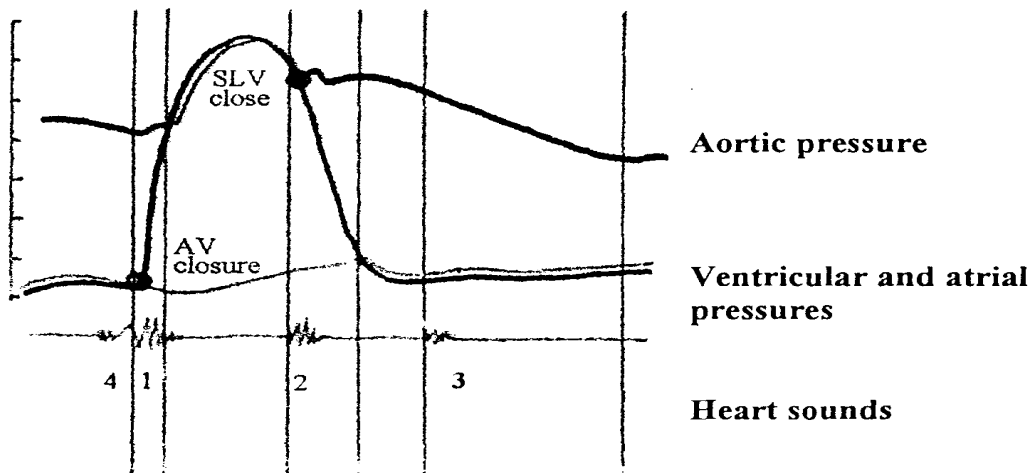

Figure 51. Valves of the heart and heart sounds

Hemodynamics

The science of **hemodynamics** concerns the relation between **blood flow**, **pressure**, and **resistance**. The heart is a complicated pump, and its behavior is affected by a variety of physical and chemical factors.

The blood vessels are multibranched, elastic conduits of continuously varying dimensions. The blood itself is a suspension of red and white corpuscles, platelets, and lipid globules suspended in a colloid solution of proteins. Despite these complicated factors, considerable insight may be gained from understanding the elementary principles of fluid mechanics as they pertain to simpler physical systems. Such principles will be expanded in this chapter to explain the interrelationships among the velocity of blood flow, blood pressure, and dimensions of the various components of the systemic circulation.

Blood flows out of the heart (the region of higher pressure) into the closed loop of blood vessels (a region of lower pressure). As blood moves through the system, pressure is lost because of friction between the fluid and the blood vessel walls. Consequently, pressure falls continuously as blood moves further from the heart. The highest pressure in the vessels of the circulatory system is found in the **aorta** and **systemic arteries** as they receive blood from the left ventricle. The lowest pressure is found in the **venae cavae**, just before they empty into the right atrium.

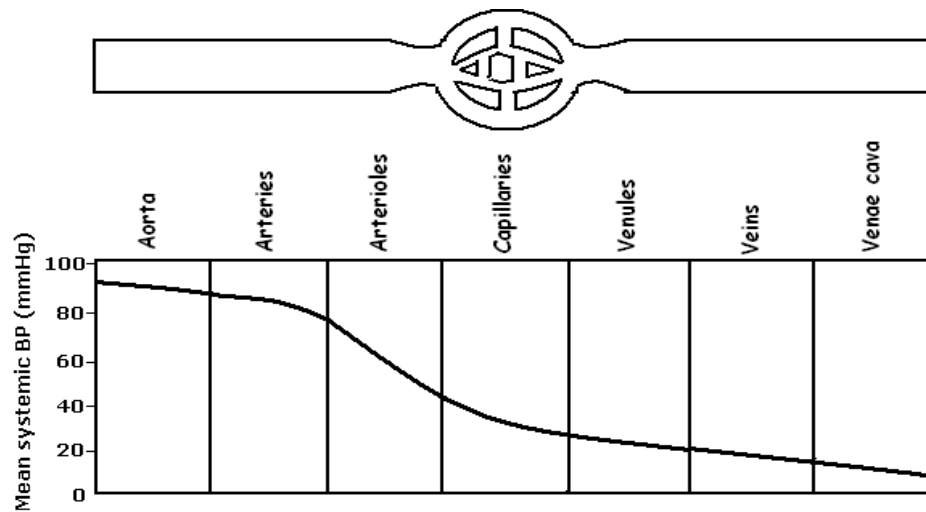

Figure 52. Pressure gradient in the blood vessels

[The mean blood pressure of the systemic circulation ranges from high 93 mmHg in the arteries to a low of a few mmHg in the venae cavae.]

Flow through a vessel is determined entirely by two factors:

- (1) The pressure difference (ΔP) between the two ends of the vessel
- (2) Resistance (R) the impediment to blood flow through the vessel

If, P_1 represents the pressure at the origin of the vessel and P_2 at the other end, the flow through the vessel can be calculated by the following formula, which is called **Ohm's law**:

$$Q = \frac{\Delta P}{R}$$

Where, Q = blood flow, $\Delta P = P_1 - P_2$, R = resistance

It should be noted especially that it is the difference in the pressure between the two ends of the vessel, not the absolute pressure in the vessel that determines the rate of flow. For instance, if the pressure at both ends of the segment were 100 mmHg, there would be no flow. Flow is inversely proportional to resistance i.e. if resistance increases, flow decreases; if resistance decreases, flow increases.

Factors affecting resistance: Poiseuille's law

For fluid flowing through a tube, resistance is influenced by three components: the length of the tube (L), the radius of the tube (r), and the viscosity (η) of the fluid flowing through the tube. The flowing equation, derived by the French physician **Jean Leonard Marie Poiseuille**, shows the relationship between these factors:

$$R = \frac{8 L \eta}{\pi r^4}$$

Because the value of $8/\pi$ is a constant, the relationship can be rewritten as:

$$R \propto \frac{L \eta}{r^4}$$

This expression says that resistance increases as the length of the tube and the viscosity of the fluid increase but decreases as the radius increases. How significant are length, viscosity, and radius to blood flow in a normal individual? The length of the systemic circulation is determined by the anatomy of the system and is essentially constant. The viscosity of blood is determined by the ratio of red blood cells to plasma and by how much protein is in the plasma. Normally, viscosity is constant, and small changes in either length or viscosity have little effect on resistance. This leaves changes in the radius of the blood vessels as the main contributor to variable resistance in the systemic circulation. When the radius of a blood vessel doubles, the resistance increases by 16-fold. Thus, a small change in the radius of a tube will have a large effect on the flow of a liquid through that tube. A decrease in blood vessel diameter is known as vasoconstriction. An increase in diameter of blood vessels is called vasodilation.

Venous system

The venous system completes the circulatory system; blood from the capillaries is drained into the veins for carrying it back to heart. Thus, veins serve as a blood reservoir, as well as transport passage back to the heart. Veins have large lumen, offering very little resistance to blood flow.

Smaller veins converge into fewer but larger radii vessels, the velocity of blood flow increases as the blood moves toward the heart. Veins also serve as a large blood reservoir and because their storage capacity, they are called as “capacitance vessels”. Veins have large lumen, thinner walls with less smooth muscle than do arteries. As they have abundant collagen tissue, veins have little elasticity in comparison to arteries. Because of these properties, veins are highly distensible or stretchable, and have little elastic recoil. They distend well to accommodate additional amount of blood with only a little rise in venous pressure. Veins with extra amount of blood simply stretch to accommodate without tendency to recoil. Recoil tendency in arteries, drives the blood forward.

When demands for blood are low, the veins can store extra blood as ‘reserve’, because of passive dispensability. In resting condition, the veins contain more than 60% of the total blood volume.

When the stored blood is needed, e.g. during exercise, sympathetic stimulation and other extrinsic factors, drive the extra blood from the veins to the heart so that it could be pumped to the active tissue.

As per Frank- Starling’s Law, increased venous return induces an increase in stroke volume of the heart. If too much blood pools into the veins, cardiac output is abnormally diminished. Therefore, a balance exists between the capacity of the veins, the extent of venous return, and the cardiac output. If more blood remains in the veins instead of being returned to the heart, such storage reduces the effective circulating volume. On the contrary, if venous capacity reduces, more blood returns to the heart, and continues circulating. Therefore, venous return is determinant of effective circulatory blood volume. The total blood volume is influenced by factors that control total ECF volume,

such as salt and water balance. Venous return refers to the volume of blood entering each atrium per minute from the veins. The flow is proportional to the pressure gradient. Since atrial pressure is '0' mm Hg, a small but adequate driving force/pressure promotes the blood flow through large diameter and low resistance veins. Pressure gradient for VR is systemic filling pressure of about 7 mm Hg resulting in venous return of about 5.5 liter/min; if this pressure falls to 5.2 mmHg, VR fall to about 4 liter/min and at pressure gradient of 5 mm Hg, cardiac output is less than 4 liter/min. During exercise, this systemic filling pressure exceeds 10 mm Hg, increasing VR and CO. If atrial pressure becomes increased due to some pathological conditions, the veins-to-atria pressure gradient decreases, reducing VR and causing the blood to dam up in the venous system, e.g. in congestive heart failure. Other than this driving pressure of 7 mmHg, and driving pressure imparted by cardiac contraction, five other factors enhance venous return (VR): venous vasoconstriction by sympathetic activation, skeletal muscle activity, the effect of vein's venous valves, respiratory activity, and the effect of cardiac suction. Most of these factors influence the pressure gradient between the veins and the heart.

Effect of Sympathetic Activity on Venous Return

Veins are less muscular, have little muscle tone, but venous smooth muscles are richly supplied with sympathetic adrenergic vasoconstrictor fibers. Sympathetic stimulation produces venous vasoconstriction, elevating venous pressure, which in turn increases the pressure gradient to drive more blood from the veins into the right atrium. Even when constricted, the veins still have large diameter and low resistance. Venos constriction mobilizes the stored blood, enhancing VR by decreasing venous capacity. Less blood coming from the capillaries remains in the veins but continues to flow toward the heart. It is to be noted that arteriolar vasoconstriction reduces blood flow through these vessels, whereas venos constriction increases flow through these veins, because of reduced capacitance, squeezes out more of the stored blood in the veins, thus increasing blood flow.

Effect of Skeletal Muscle Activity on Venous Return

Many large veins in the extremities lie between skeletal muscles, so as muscles contract the veins are compressed; this reduces venous capacity, increases venous pressure, squeezing blood in the veins forward toward the heart. This blood pumping action is known as the 'skeletal muscle pump', returning extra blood stored in the veins to the heart, during exercise. In exercise, venoconstriction and sympathetic activity also accompanying exercise, further enhances venous return.

The skeletal muscle pump also opposes the gravitational effect on the venous system. When a person is lying down in a bed, the force of gravity is uniformly applied. However, when a person stands erect, gravitational effects are not uniform. The vessels below the heart level are subjected to pressure caused by the weight of the column of blood extending from the heart to the level of the vessel.

This increase in pressure has two consequences; the distensible veins give way under the increased hydrostatic pressure, further distending them, so that their capacity to accommodate blood is increased. Arteries are less distensible, so they do not expand like the veins to the same gravitational effects. In erect posture, much of the blood from the capillaries pools into the expanded veins, instead of returning to the heart. As venous return diminishes, cardiac output falls, and the effective circulating volume is decreased. Gravity increases pressure in the capillaries, causing excessive fluid to filter out of capillary beds in the lower limbs, producing edema of feet and ankles.

Two compensatory mechanisms counteract these gravitational effects. Resultant fall in arterial blood pressure on standing from supine position, triggers sympathetic-induced venous vasoconstriction, which moves some of the pooled blood forward. The skeletal muscle pump 'interrupts' the column of blood by completely emptying veins blood segments intermittently so that a portion is not subject to the entire column of venous blood from the heart to its level.

Skeletal muscle pump activity and sympathetically-induced venous Vasoconstriction together completely compensates for gravitational effects. If a person stands still for a long time, blood flow to the brain is reduced because of the decline in effective circulating blood volume, despite reflexes targeted for maintaining arterial blood pressure, Decreased cerebral blood flow leads to fainting, which returns the person to a horizontal position, thereby eliminating the gravitational effects and restoring effective circulating volume toward normal. Fainting is the remedy to the problem, not the problem itself.

Effect of Venous Valves on Venous Return

Both venoconstriction and skeletal muscle pump drive blood in the direction of the heart and not backwards because the large veins have one-way valves spaced at 2 - 4 cm gaps, permitting blood to move forward toward the heart but prevent it from moving backward toward the tissue. They also counteract gravitational effects in upright posture by helping minimizing the backflow of blood that tends to occur as a person stands up. They support the blood column when the skeletal muscle is relaxed.

Role of Respiratory Activity on Venous Return

During respiratory excursions, the pressure within the thoracic cavity averages 5mm Hg less than atmospheric pressure. Blood returning from the lower body parts to heart travels through the chest cavity, where it is exposed to subatmospheric pressure. The venous system of the lower extremity and abdomen is exposed to normal atmospheric pressure. This pressure difference of about 5 mmHg subatmospheric, squeezes blood from lower veins to the chest veins, enhancing venous return. This mechanism of facilitating venous return is known as the Respiratory pump. So during exercise, respiratory pump, skeletal muscle pump and venous vasoconstriction enhance venous return.

Effect of Cardiac Suction on Venous Return

The heart has role in its own filling with blood. During ventricular contraction, the trioventricular valves are pulled downward increasing the atrial cavities, as a result there

is transient drop in the atrial pressure, thus increasing vein-to-atria pressure gradient, so that venous return is facilitated. During ventricular relaxation, a transient negative pressure is created in the ventricle, so that blood is 'sucked in' from the atria and veins; thus the negative ventricular pressure increasing the vein-to-atria-to-ventricles pressure gradient, further enhancing venous return. So heart functions as a "suction pump" for its own filling.

CARDIAC OUTPUT

Cardiac output is the amount of blood ejected by either ventricle per minute. The volume of blood returning to the left atrium from the lungs is the same volume, which was released by the right ventricle to the lungs; the output of the right and left ventricles is normally the same.

Cardiac output of a young adult female 67 kg, reclining = about 5L/min. "male of same age & wt = 10% more = 5.5 L/min.

Cardiac Reserve: Cardiac reserve is the difference between the CO at rest and the maximum amount the heart is capable of pumping per minute. Cardiac output is affected by age, changes in posture, and exercise. It may be 20 –25 L/min in exercise and in very severe strenuous exercise in a trained athlete 35 – 40 L/min.

During anytime, the volume of blood flowing through the pulmonary circulation is the same as flowing through the systemic circulation. The two determinants of cardiac output are heart rate (beats/min) and stroke volume (SV) i.e. volume of blood pumped/beat or stroke.

The average HR= 70 beats/min (established by SA Node rhythmicity)

“ SV =70 ml/beat

“ CO = 70 x 70 = 4900 ml/min or close to 5 liter/min

The body's total blood volume averages 5 to 5.5 liters, each ventricle pumps the equivalent amount of blood/minute; right ventricle to the lungs and the left through the systemic circulation.

FACTORS INFLUENCING CARDIAC OUTPUT

The most important factors influencing CO are of two categories: (See figure 49).

1. Cardiac factors: heart rate & stroke volume, sympathetic stimulation and myocardial contractility;
2. Systemic factors: Venous return is an important controlling factor. The heart is a “demand pump” adjusting its output to the demand of the body organisms.

Heart rate is determined primarily by influence on the SA node. The sino-atrial node (SA Node) is the pacemaker of the heart as it has highest rate of spontaneous depolarization due to a complex interplay of ions: low potassium constantly increasing sodium and increasing calcium Permeability. This action potential spreads through the heart, inducing the heart to contract or have a “heart beat”. This happens at about 70 beats/min.

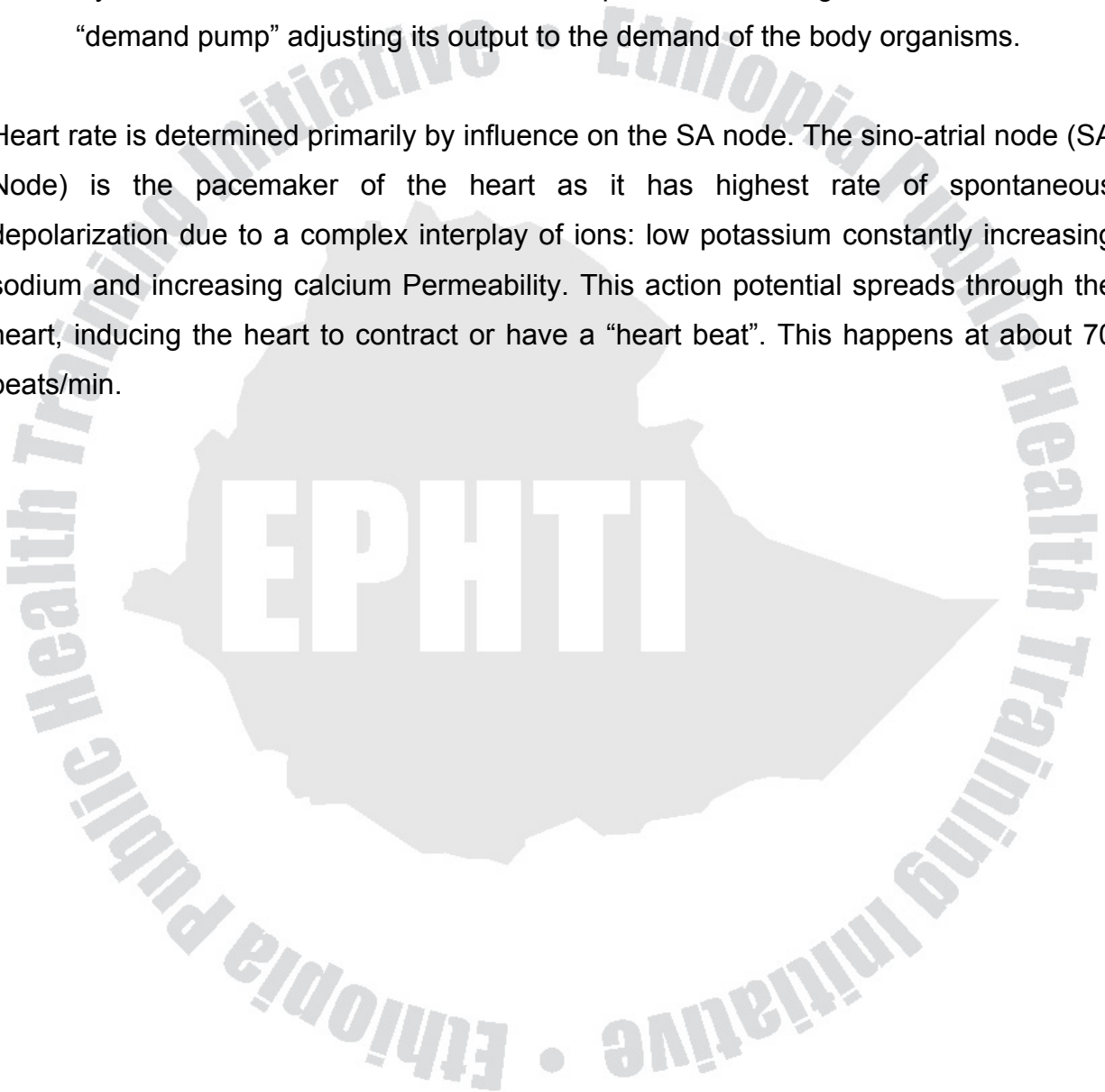

Cardiac Out put in resting/supine position: ~ 5.0L/min (70 mlx72 beats/min)
 Cardiac index: ~3.2L
 CO and VR are inextricably independent

AFTERLOAD

The force, or resistance against which the heart must pump to eject blood.

→ Arterial blood pressure, valves stenosis

CO= volume /unit time

HEART RATE

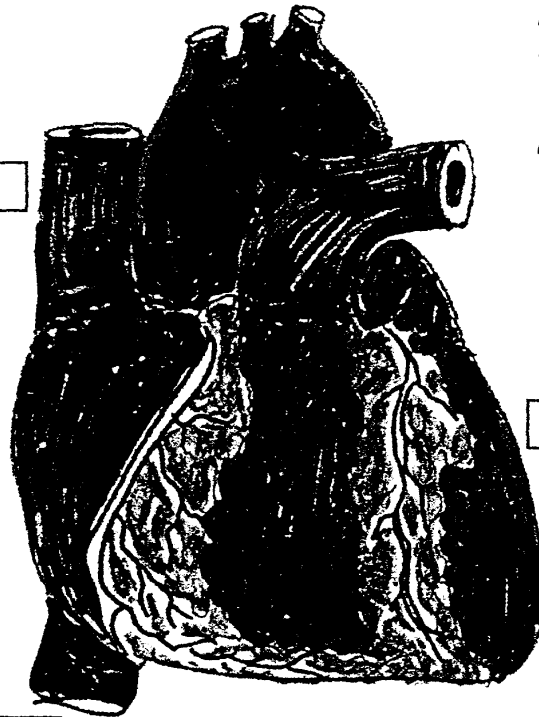

VR=volume/unit time

CARDIAC CONTRACTILITY

- Length-tension relationship (VEDV).
- Heterometric autoregulation.
- Homeometric autoregulation
- ANS control & circulating catecholamines
- Force-Frequency relation

PRELOAD

- Ventricular filling
- Degree to which the myocardium is stretched

VENTRICULAR END DIASTOLIC VOLUME: FACTORS INFLUENCING IT

- ✓ Strong atrial contraction
 - ✓ Increased total BV
 - ✓ Increased venous tone
 - ✓ Increased pumping action of SK. Muscle
 - ✓ Increased negative intrathoracic pressure
- ↑
- ✓ Standing
 - ✓ Increased intrapericardial pressure
 - ✓ Decreased ventricular compliance
- ↓

Figure 53. Factors affecting cardiac output.

Effects of parasympathetic stimulation on the heart rate

The parasympathetic nervous system influence on the SA Node is to decrease heart rate; acetylcholine- mediated effect on the permeability of the SA node reducing spontaneous action potential through the following effects;

- Increased potassium permeability hyperpolarizes the SA node membrane because of increased potassium ions efflux, making the inside more negative.
- This increased potassium permeability also opposes the automatic reduction in potassium permeability that initiates depolarization of the membrane to threshold. Thus SA node reaches threshold more slowly and fires signals less frequently, reducing the heart rate. Parasympathetic activation on the AV node reduces its excitability, prolonging the impulse transmission to the ventricles as a result of increased potassium permeability (hyperpolarization), thereby retarding the excitation of AV node. Atrial contraction is weakened by a reduction in the slow inward current carried by calcium, reducing the plateau phase. The parasympathetic has little effect on ventricular contraction. Thus, the heart beats slowly, atrial contraction is weaker, the time between atrial and ventricular contraction is stretched out. These actions are beneficial because parasympathetic controls heart activity in quiet relaxed condition of rest when body is not demanding increase in cardiac output. This is achieved by vagal tone at rest (with heart rate at rest being 70 beats/min, though the inherent rhythmic rate of the SA Node is about 100 beats/ minute).

Effects of Sympathetic stimulation on heart

The sympathetic nervous system controls heart rate in emergency or exercise situation, when there is need for more blood flow; heart rate is increased through effect on the pacemaker SA Node. Sympathetic stimulation increases the rate of depolarization reaching threshold more rapidly mediated via norepinephrine by decreasing potassium permeability by inactivation of potassium channels; greater frequency of action potential and corresponding more rapid heart rate.

- Sympathetic stimulation decreases AV node delay, by enhancing the slow, inward calcium ion current.
- Sympathetic stimulation speeds up the spread of the action potential throughout the specialized conduction tissue/pathway
- Sympathetic stimulation increases contractile strength in the atria and ventricles so that heart beats more forcefully and squeezes out more blood; this is by increasing calcium ions permeability, enhancing the slow calcium ions influx and enhancing calcium-dependent excitation-contraction coupling process.

The overall effect of sympathetic stimulation is to increase heart rate, decrease conduction time, and increase force of myocardial contraction. Therefore, parasympathetic and sympathetic effects on heart are antagonistic. Under resting condition parasympathetic dominates. Heart rate is increased by simultaneous stimulation of sympathetic and inhibition of parasympathetic activity. A decrease in heart rate by stimulating parasympathetic and inhibiting sympathetic activity. These two autonomic branches to the heart in turn are primarily controlled by the cardiovascular control centers in the brain stem. Medullary epinephrine too acts on the heart in a manner similar to postganglionic sympathetic neurotransmitter norepinephrine, thus, reinforcing the direct effects of the sympathetic nerves.

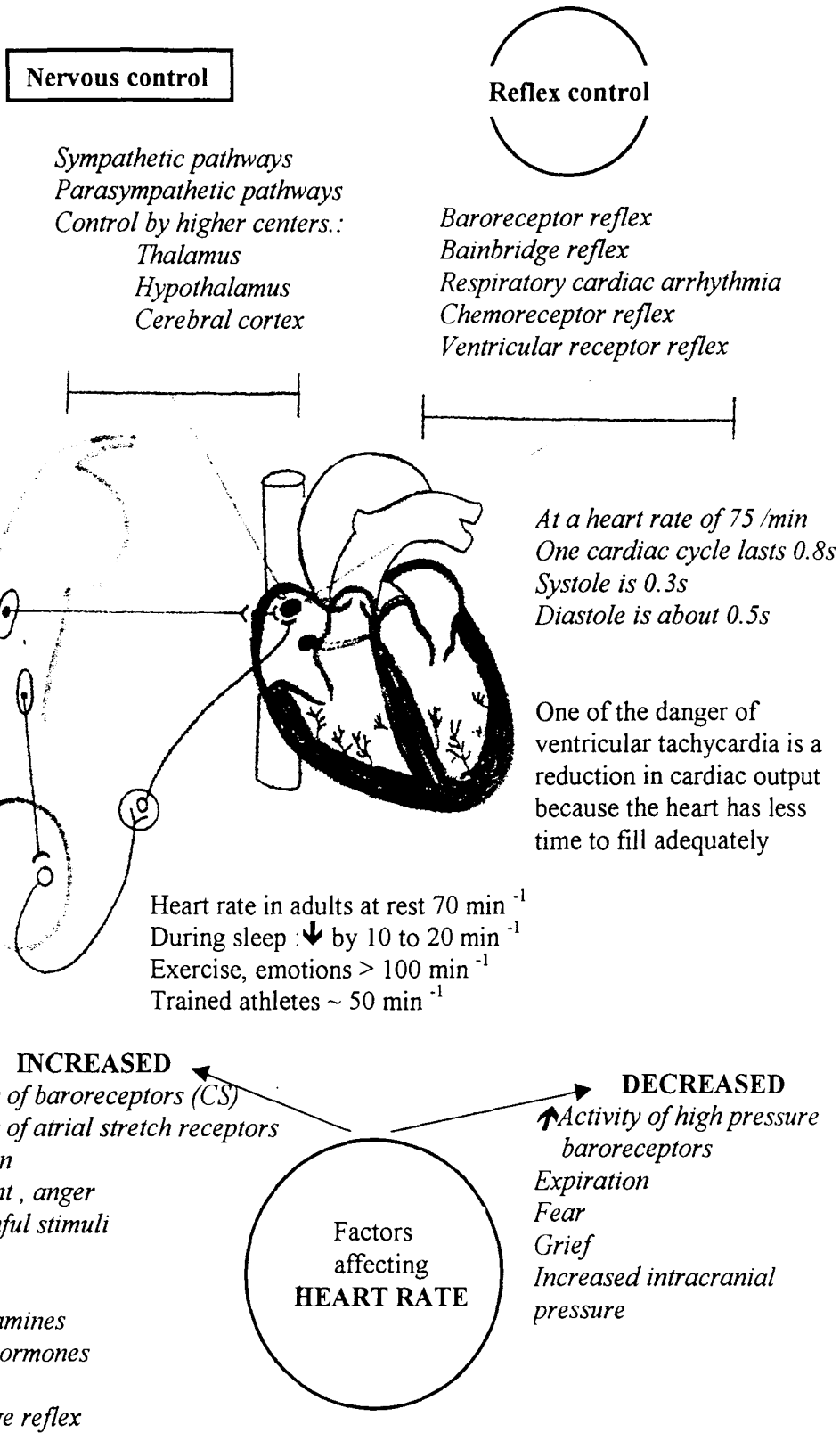

Figure 54. Regulation of the Heart rate.

Stroke volume: is determined by the extent of venous return and by sympathetic activity. Stroke volume (SV) is the amount of blood pumped out by each ventricle into great vessels (aorta/pulmonary artery) during each beat. Stroke volume is another determinant for the cardiac output. Two types of mechanisms control stroke volume:

1. Intrinsic control related to the extent of venous return heterometric auto-regulation, a length-tension relationship, or Frank-Starling Mechanism; and
2. .Extrinsic control related to the extent of sympathetic stimulation of the heart - The homeometric regulation depending on extrinsic nerves and hormones (medullary catecholamine).

Increased End Diastolic Volume Results In Increase in Stroke Volume

As more blood returns to the heart, the heart pump more blood but does not empty all the blood it contains. There is a direct relation between end-diastolic-volume (EDV) and stroke volume; that refers to the heart's inherent capability to vary the SV. This control depends on the length-tension relationship of cardiac muscle, similar to that of skeletal muscle. An increase in cardiac muscle fiber length increases the contractile tension of the heart on the following systole. The cardiac muscle is not attached to bone, like skeletal muscle. The main determinant of cardiac muscle fiber length is the degree of ventricular filling during diastole. The greater the extent of ventricular filling, during diastole, larger is the end-diastolic-volume and more is the heart stretching. Therefore, with more stretch, the longer the initial cardiac muscle fiber length in diastole before contraction in systole. Thus, increased length results in a greater force on the subsequent cardiac contraction, and therefore, a greater stroke volume. This relationship is intrinsic between EDV and SV and known as the Frank Starling's law of the heart. It means increase in VR results in increased SV. The extent of filling is known as 'preload', because it is the workload imposed on the heart before contraction begins. It is to be noted that within physiological limits cardiac muscle does not get stretched beyond its optimal length to the point that contractile force decreases with further stretching (it happens in heart failure)The advantage of this matching SV and VR by intrinsic mechanisms is:

- When a larger cardiac output is needed, e.g. in exercise, VR is increased through action of the sympathetic nervous system and other factors. The resultant increase in EDV automatically increases stroke volume. In exercise heart rate also rises so both increases in SV and HR increase the cardiac output, so that more blood can be delivered to the active muscles.
- Both the right and left ventricles have equal output, equally distributed in the two circulation

The contractility of the heart is increased by sympathetic stimulation. Factors outside the heart also control SV in addition to intrinsic control. The most important of this extrinsic control is the action of cardiac sympathetic nerves and epinephrine; both increase the heart's contractility leading to more complete ejection. The increased contractility is due to the increased calcium influx triggered by norepinephrine and epinephrine. Increased cytosolic calcium ion concentration generates more force of contraction through greater cross-bridge cycling than would be possible without sympathetic stimulation. In normal EDV is about 135 ml, it may be 35 ml and 100 ml stroke volume at the end of systole. Therefore, the Frank-Starling's curve shifts to the left, depending on the extent of sympathetic-induced myocardial contraction that could be about 100% greater than normal.

Sympathetic stimulation increases SV by increasing cardiac contractile force but also by enhancing VR by venous vasoconstriction squeezing more blood from veins to the heart, increasing ventricular end-diastolic volume and subsequently increasing the SV even further.

The ability of the heart to increase cardiac output to meet body's demands as a person grows older, i.e. the cardiac reserve decreases with aging. It may be on account of reduced norepinephrine from the sympathetic postganglionic neurons; it is related to diminished calcium-mediated exocytosis of neurotransmitter - eventually to do with the calcium channels.

High blood pressure increases the workload of the heart. During systole, ventricles need to generate sufficient pressure to exceed the blood pressure in the major elastic arteries in order to force open the aortic valve. The arterial blood pressure is referred to as the 'after-load', because it is the workload imposed on the heart after the contraction begins. If the ABP is chronically high or if the valves are shrunken, ventricles have to generate much more force to eject blood e.g. instead generating 120 mmHg pressure, a pressure as high as 400 mm Hg may be needed to eject blood through a narrowed aortic valve. The heart undergoes compensatory hypertrophy for a sustained increase in afterload, enabling it to contract with more force maintaining a normal stroke volume despite the impedance to ejection. A diseased heart or weak heart with aging may not be able to compensate completely. In that case, heart failure develops. Even with initial compensation, a sustained extra workload placed on the heart can eventually cause pathological changes in the heart leading to heart failure. This is one of the major causes of heart failure.



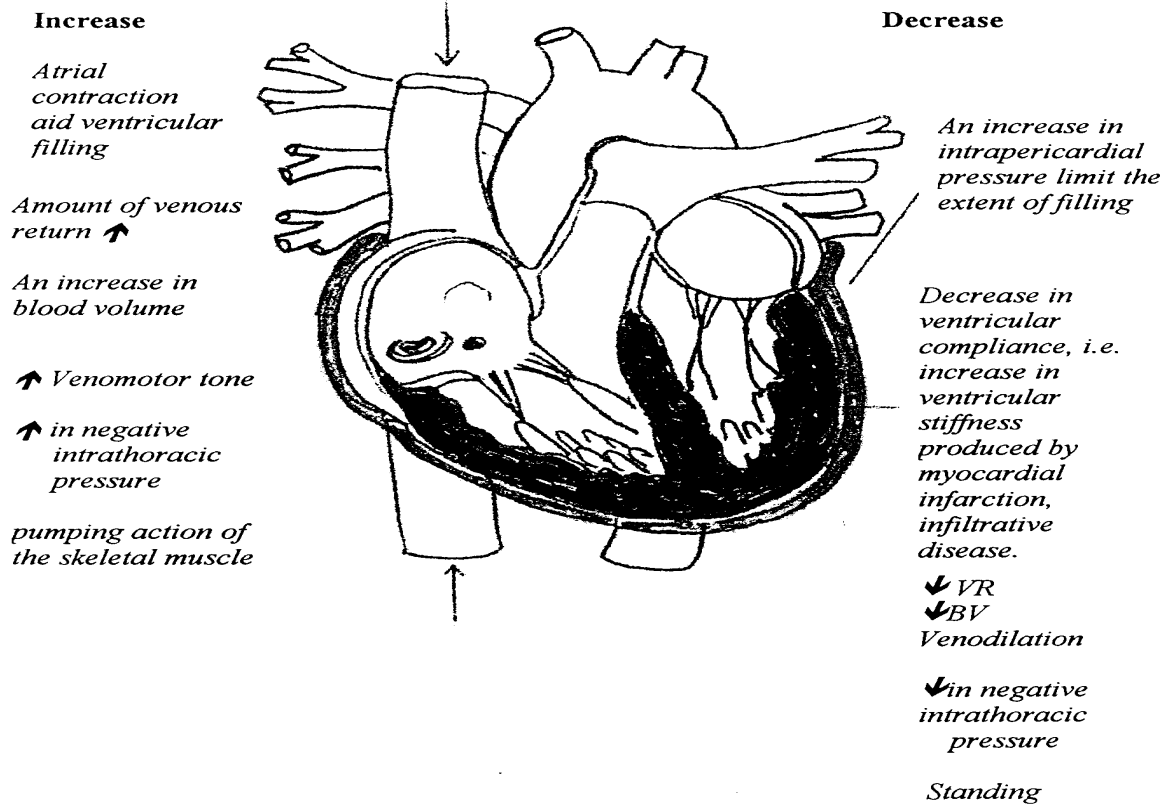

Figure 55. Factors affecting end-diastolic volume.

CARDIAC output during exercise

Exercise is the most effective way to increase cardiac output. Increase in heart rate, stroke volume, and venous return all contribute to the augmented cardiac output.

- In acute exercise, sympathetic stimulation of the heart and blood vessels and increased venous return from the active muscles are the dominant factors regulating the increase in cardiac output.
- The sympathetic nervous system affects both the inotropic and chronotropic characteristics of the heart
- As a result of the sympathetic stimulation of the heart, cardiac contractility is improved, shortening the time needed for diastolic filling.

- Increase in heart rate during exercise is chiefly due to sympathetic stimulation, while there is reduction in vagal nerve discharge.
- During and just before the start of strenuous exercise, there is a marked vasoconstriction of blood vessels in the splanchnic area, shunting blood from the viscera into the thoracic region and increasing venous return to the heart.
- During exercise, sympathetic stimulation of the smooth muscles of the blood vessels increase peripheral resistance and venous return
- The actively contracting muscles during exercise exert pressure on the veins, and, aided by the venous valves, the blood is forced back toward the heart. The end-diastolic volume of the heart is increased by the volume of the blood with which it is filled, stroke volume is increased by Frank-Starling mechanism and the cardiac output is improved. The cardiovascular centers in the brain integrate these responses of the heart and blood vessels.

Effect of training on cardiac output.

Although heart rate, stroke volume, and venous return increase contributing to increase in cardiac output, the extent of contribution varies significantly in trained and untrained individuals

- The athlete's heart is usually larger than that of sedentary individuals. Constant and regular training, with the increased workload against which the heart contracts, results in heart muscle compensatory hypertrophy, an increase in size, increase in contractile proteins, myoglobin, and cellular enzyme systems. These biochemical changes increase the inotropic force of the heart, increasing stroke volume and permitting the athlete to achieve the same cardiac output with a slower heart rate.

- The heart rate in an athlete at rest may be as low as 45-50 due to vagal tone, but the increased stroke volume of 100 -110 ml/beat results in normal cardiac output of about 5.5 liter/min Thus, an athlete has to increase heart rate proportionately less during strenuous exercise than does an untrained person. This allows better diastolic filling

and contributes, along with greater contractile force of the hypertrophied heart, to an enhanced cardiac output.

- In trained athletes, increased stroke volume also appears to help increase in cardiac output. In untrained persons, increased cardiac output is achieved through increased heart rate.

Effect of posture (Gravity) on venous return and cardiac output

One of the most important adaptations in the bipedal life is the ability to maintain blood pressure in the standing position, despite the fact that the heart and head are considerably above the center of gravity of the body. This adaptation is reinforced by a good active life.

Recumbent Position: In the recumbent posture, more than 50% blood is present within the systemic veins, about 30% in the intrathoracic vessels and less than 15 to 20% in the systemic arteries. It is the low pressure venous system that is involved in shifting in blood volume. Heart size is greater in the lying position because there is little venous pooling in the leg, and most of the venous blood is in the intrathoracic compartment, able to fill the heart.

Standing position: On standing, large displacement of blood volume occurs in response to gravitational effect. The most extensive pressure changes occur in the legs, as blood accumulates in the lower limbs. Intravascular pressure decrease above the level of right atrium and increase in the dependent parts below the right atrium. Much of the blood pooled in the legs is displaced from the intrathoracic vascular area during quiet prolonged standing. This significantly reduces the volume of blood in the heart and the pulmonary circulation. Stroke volume and cardiac output fall significantly - a 20% decrease in cardiac output. Abrupt fall in cardiac output is compensated by the cardiovascular responses; first, by a reflex stimulation of heart rate through the sympathetic nerves, and secondly, by strong vasoconstriction in the splanchnic and skin area, that results in increasing the blood shunting to the thoracic area, and increasing peripheral resistance. However, these cardiovascular responses alone cannot fully

compensate for a change to standing position. The action of muscle pump is needed to exert external pressure on the veins and push the venous blood toward the heart. This skeletal muscle pump is aided by unidirectional venous valves. The rhythmic contraction and relaxation of skeletal muscles characteristic of vigorous running, cycling, jogging, or skiing are especially effective in activating the skeletal muscle pumping action of the legs. The effect of posture and exercise on blood pressure, pulse.

Prolonged standing: With prolonged standing, there is a decrease in blood flow through the kidneys, with a marked rise in the production of angiotensin-II, a powerful vasoconstrictor and of aldosterone as a result of renin-angiotensin system. Aldosterone causes the retention of salt and water by the kidneys, which increases plasma volume and compensates to some extent for the fall in arterial blood pressure. At the same time, there is about 20% decrease in blood flow to the brain during prolonged standing, and in case the muscle is not kept contracting rhythmically, fainting is more likely to occur.

Prolonged bed rest. During prolonged bed rest the entire body is affected by gravitational forces, often resulting in a temporary inability to changes in posture. Sudden sitting or standing may induce blackout and unconsciousness.

Blood Volume and viscosity

Blood volume normally remains constant, but decreases following hemorrhagic or traumatic shock; there is sharp drop in circulating volume, a fall in venous return, and a pronounced decrease in cardiac output and blood pressure. A rapid loss of 25% of the total blood volume in hemorrhage will reduce cardiac output to almost zero, causing circulatory shock. This results in inadequate tissue perfusion, resulting in progressive tissue damage. The damage involves the cardiovascular system as well as the other tissues of the body, so that the cardiac muscle, the blood vessels, and the vasomotor system degenerate, initiating a vicious cycle where by deterioration cardiovascular system becomes progressively incapable to supply the tissues with blood. This vicious cycle leads to death unless appropriate treatment is given on time. Similar picture

develops if more than 40% of total blood volume is lost if the bleeding occurs more slowly from one to several hours.

High altitude promotes increased red cell production and causes a mild polycythemia; people living at more than 4700 m have red cell count of 6-8 million per cu mm of blood. Acclimatization to high altitude also increases vascularity of the tissues that lowers total peripheral resistance and tries to counteract high red cell count and increased peripheral resistance. Cardiac output is only slightly increased.

In polycythemia vera, the bone marrow becomes malignant and hematocrit may rise from a normal value of 40 – 45% to even 70 –80% blood viscosity rises sharply, peripheral resistance increases, and cardiac output falls.

Anemia decreases viscosity, and together with the vasodilatation due to tissue hypoxia, causes a fall in total peripheral resistance and an increase in cardiac output, so that tissue at rest get enough oxygen, But heart has no reserve to use for the demands of exercise and severe exercise may result in heart failure.

Blood Vessels

The cardiovascular system is designed to provide widely varying metabolic needs under changing physiological circumstances, without overburdening the heart. Two mechanisms i.e. local control of blood flow matching the metabolic needs - autoregulation and 'neural control' of the resistance of peripheral arterioles, accomplish the response of the vascular system. These two factors:

- Control blood flow and consequently regulate the cardiac output
- Are influenced by such factors that control extra cellular fluid volume

Microcirculation

Microcirculation is the organization of the micro-size blood vessels that are present between the arterioles and venules; their number and size of these vessels vary significantly in different vascular beds, many of which have specialized features befitting

a special function. The organization is not the same, e.g., in the brain, the lungs, and the spleen.

The vessels included in the microcirculation are:

- Terminal arterioles
- Meta -arterioles
- Arterioles
- Arteriovenous anastomoses
- Capillaries
- Post capillary venules

The terminal arterioles are narrow muscular vessels, having a diameter of 35-50 microns and conduct blood directly into the meta arterioles; both the terminal arterioles are the resistance vessels of the microcirculation.

Capillaries

- Are the thin-walled exchange vessels forming a network linkage between narrow meta arterioles and wide-lumen venules.
- Have low velocity of blood flow (0.5 - 0.7 mm/sec but a very large surface area of (e.g. in skeletal muscle 2000 capillaries/mm²)
- Is the site for the exchange of fluid, nutrients; gases; blood flows only for a very brief period (2 - 5 sec in a capillary 1 - 2 mm long).
- Diameter varies with the functional state of the tissue; narrow in inactive tissue with little or no blood flow; there is an autoregulation of blood flow in the tissue are narrower they pass through capillaries.
- Are of three types, according to their structure and function; all capillaries have single layer of endothelial cells on a thin basement membrane of glycoprotein and do not have muscles or elastic fibers.

Continuous Capillaries (skeletal muscle): entire circumference is made up of one endothelial cell, ends overlapping each other, forming a tight seal; many intracellular vesicles take part in transport of materials.

Fenestrated Capillaries: Have a very thin area of endothelial membrane stretched between adjacent endothelial cells. These fenestrations are not open holes but are closed by a thin diaphragm; these types are found in the capillary tuft /glomerulus of the kidney, in endocrine glands, and in the intestine providing very high permeability. There is no diaphragm between the adjacent endothelial cells that ensures rapid passage of substances through the capillaries e.g. in the kidney.

Sinusoids: are more wide, more irregular in size and shape than capillaries; sinusoid structure is present in liver and the spleen; in the liver, the sinusoids are lined by an incomplete layer of fenestrated endothelial cell, which increases permeability still preventing passage of many small molecules, such as albumin. Liver sinusoids are also lined by macrophages.

Postcapillary venules collect blood from the capillaries, have no muscle and elastic tissue like the capillaries; are wider than the capillaries (15-20 microns); some exchange seems to occur in these vessels; these vessels are very susceptible to inflammation.

Viscosity and laminar flow

According to the Poiseuille's Law, viscosity is one of the parameter of resistances to flow. Laminar flow is a characteristic of blood flow in large vessels of the circulation; the laminae move parallel to each other in longitudinally oriented concentric sleeves, each sleeve moving at a different rate. Not all the layers move at the same rate, but rather at different rates. The viscosity of blood depends on the hematocrit. In leukemia and polycythemia, blood viscosity may rise markedly, increasing systemic and pulmonary resistance and consequently raising blood pressure. In anemia, viscosity falls.

The bore of the vessel also affects viscosity; it decreases as the vessel diameter falls below 150 micron. Blood viscosity may be half in capillaries to the large arteries. This

is increase in viscosity as blood velocity decreases, an effect probably due to increased adherence of the red cells to each other.

Turbulent blood flow

If the velocity of flow is very high, or if the blood has to pass an obstruction vessel, flow becomes turbulent so that eddy currents are formed. Turbulence increases vascular resistance significantly. It is important in determining blood pressure.

Cross-sectional area and flow velocity

The mean velocity of blood flow is inversely proportional to the cross-sectional area provide that the total volume of fluid flowing through each segment is constant.

Blood volume distribution & blood pressure

Blood volume is very unevenly distributed through the various vascular segments even though the volume flowing through is relatively constant. The veins have more than 75% of total blood volume. Thick, elastic arteries and arterioles contain 18%, capillaries hold only 3-4 percent of blood volume, while the heart contains about 7% blood pressure is almost inversely proportional to volume distribution and vascular resistance. In the large aorta resistance is very low and the MABP is about 100 mmHg. There is little change in pressure in large arteries, but resistance increases rapidly in small arteries, causing the pressure to drop to about 70 mm Hg at the beginning of the arterioles. The arterioles have the greatest resistance of the systemic circulation, so that by the time blood reaches the capillaries, pressure has dropped to about 30 mmHg. Arteriolar resistance is profoundly affected by sympathetic stimulation.

Measurement of arterial pressure

A. Direct methods

1 Mercury manometer

The principle behind manometry is that the vertical column of manometer fluid exerts a downward Pressure which opposes the blood pressure. When the column reaches a stable height (h), the blood pressure must be equal to the pressure at the bottom of the column, namely ρgh (fluid density $\rho \times$ force of gravity $g \times h$). Since mercury is very dense ($\rho=13.6\text{g/ml}$), a column of about 100mm high suffices to balance blood pressure.

2. Electronic pressure transducer

To record the pressure wave form, a fast-responding electronic pressure transducer is needed.

The transducer contains a metal diaphragm which deforms slightly when arterial pressure is applied to it via a catheter. The deformation of the diaphragm alters the resistance of a wire Connected to it and the resistance is recorded.

B. Indirect methods

Auscultator method (sphygmomanometry)

The mercury manometer is used in medical practice throughout the world to measure human blood pressure, by an indirect method called sphygmomanometry.

- A Riva-Rocci cuff (blood pressure cuff), which is an inflatable rubber sac within a cotton sleeve is wound around the upper arm, with the inflatable sac located medially over the brachial artery at heart level.
- The cuff is inflated initially to a pressure that obliterates the radial pulse. In a normal elderly subject this might be 180mmHg. The applied pressure being measured by mercury manometer.
- A stethoscope is place over the antecubital artery.

- The applied pressure (by inflated cuff) is transmitted through the tissues of the arm and occludes the artery. Auscultation of the brachial artery at the antecubital fossa (inner aspect of elbow) with a stethoscope therefore reveals no sound at this stage.

- Cuff pressure is then gradually lowered, and a sequence of sounds is heard.

As long as this pressure is higher than systolic pressure, the brachial artery remains collapsed and no blood whatsoever flows into the lower artery during any part of the pressure cycle.

- When the cuff pressure is just below the systolic pressure, the artery opens briefly during each systole. The transient spurt of blood vibrates the artery wall downstream and creates a dull tapping noise called Korotkoff sound. (The exact cause of Korotkoff sound is still debated, but it is believed to be caused by blood jetting through the partly occluded vessel. The jet causes turbulence in the open vessel beyond the cuff, and this sets up vibrations heard through the stethoscope).
- The pressure at which the Korotkoff sound first appears is conveniently accepted as systolic pressure, though it is actually about 10mmHg less than the systolic pressure measured directly.
- As the pressure in the cuff is lowered still more, the Korotkoff sounds change in quality. The sound, this time, has less of the tapping quality but more of a rhythmic harsher quality. The sounds grow louder, because intermittent spurts of blood grow stronger.
- When the pressure in the cuff falls equal to diastolic pressure, the artery no longer closes during diastole, which means that the basic factor causing the sounds (the jetting of blood through a squeezed artery) is no longer present. Therefore, the sounds suddenly change to a muffled quality and usually disappear entirely.
- The pressure at which the Korotkoff sounds disappear is accepted as the diastolic pressure (though it is about 8mmHg higher than diastolic pressure measured directly).

Direct versus indirect methods

Several investigators have compared the pressure readings obtained from a cannula inserted into the brachial artery in one arm with the recordings obtained in the other by the auscultatory method. Considerable discrepancies have been observed. The indirect

method usually gives readings of SBP about 25mmHg lower than the 'true' SBP given by the direct method. The DBP reading by the indirect method is on average 8mmHg higher. Although indirect sphygmomanometry does not give an accurate (absolute) measurement of either SBP or DBP, yet the indirect method is of great practical value in medicine.

Normal values

Many attempts have been made to define normal values for blood pressure but all such efforts have been unsatisfactory. That mythological polymath "every schoolboy" knows that 'normal' human blood pressure is 120/80mmHg. For an adult under certain conditions he would be right, but it is quite wrong to adopt 120/80 mmHg as the normal standard for a resting child, a pregnant woman in midterm or an elderly man.

Mean arterial pressure (MAP)

The mean arterial pressure is the average of all the pressures measured millisecond over a period of time. It is not equal to the average of systolic and diastolic pressure because the pressure remains nearer to the diastolic pressure than to the systolic pressure during the greater part of the cardiac cycle. MAP is defined as being approximately equal to the diastolic pressure plus

One-third of the pulse pressure:

$$\begin{aligned} \text{MAP} &= \text{Diastolic pressure} + \frac{1}{3} (\text{systolic pressure} - \text{diastolic pressure}) \\ &= 80\text{mmHg} + \frac{1}{3} (120-80\text{mmHg}) \\ &= 93 \text{ mmHg} \end{aligned}$$

This formula for MAP applies to a person, whose heart rate is in the range of 60-80beats/min, a typical resting heart rate. If heart rate increases, the relative amount of time the heart spends in diastole decreases. In that case, the contribution of systolic pressure to MAP increases.

The MAP is the most important of the pressures described because it is the pressure driving blood into the tissues averaged over the entire cardiac cycle. We can say mean 'arterial' pressure without specifying to which artery we are referring because the aorta and other large arteries have such large diameters that they offer only negligible resistance to flow, and the MAP are therefore

Similar everywhere in the large arteries.

Factors affecting the blood pressure

Some of the factors affecting blood pressure as follows:

Age

MAP increases progressively with age. The increase in pulse pressure is especially striking and is caused by reduced arterial compliance. Reduced compliance is due to arteriosclerosis (hardening of the arterioles by fibrosis and calcinosis), and is universal accompaniment to ageing. As a very rough rule, SBP equals to 100mmHg plus age in years.

Sleep and exercise

Blood pressure can fall below 80/50mmHg during sleep. In exercise, MAP may either rise or fall, depending on the balance between increased cardiac output and reduced peripheral vascular resistance. The gentle dynamic exercise pressure can fall slightly, and even in heavy dynamic exercise, where cardiac output increases fourfold or more, the MAP increases by only 10-40mmHg. In heavy static exercise, such as weightlifting, an 'exercise pressor reflex' can elevate pressure by approximately 60mmHg.

Gravity

a. direct effect

Pressure increases in arteries below heart level owing to the column of blood between the heart and the artery. In a foot 115cm below heart level, arterial pressure will increase by $115 \times 1.06 / 13.6$ cmHg (1.06 is the relative density of blood and 13.6 the

relative density of mercury); this is 90mmHg, so arterial pressure in the foot is increased to approximately 180mmHg above atmosphere pressure. Conversely, pressure is reduced in the arteries above the heart level and is only 60mmHg or so in human brain during standing.

b. Indirect effect

Upon moving from lying to standing, arterial pressure changes at heart level due to changes in cardiac output and peripheral resistance. A transient fall in aortic pressure (which can produce a passing dizziness) is followed by a small but sustained reflex rise.

Emotion and stress

Anger, apprehension, fear, stress, and excitement are all potent 'pressor' stimuli, i.e. they elevate blood pressure. Even a telephone conversation raises pressure by around 10mmHg. Compared with the relaxed states, while attending a meeting often raise it by 20mmHg. Since a visit to the doctor is stressful for many patients, a solitary high pressure measurement is not itself proof of the disease 'hypertension'; the measurement needs to be repeated with the patient relaxed. The pressor effect of stress is particularly harmful to patients with ischemic heart disease.

Other factors

Respiration: Arterial pressure fluctuates with respiration. In supine young adults, MAP falls by a few mmHg with each respiration, because of the reduction in left ventricular stroke volume.

Valsalva maneuver: Valsalva maneuver, a forced expiration against a closed or narrowed glottis, causes a complex sequence of pressure changes.

Pregnancy: In pregnancy blood pressure gradually falls and reaches a minimum at approximately 6 months.

Full bladder: Full bladder can raise blood pressure.

Distensibility and capacitance of blood vessels

The aorta at normal pressure 75-100 mm Hg, shows good distensibility and elastic recoil, loses this property at higher pressures when the vessel is overfilled and the limits of distensibility are reached. Veins don't show distensibility are filled; they contain 3-times blood volume than in that of arteries. Veins have more capacity arteries expand and recoil, store pressure during systole of the heart and release it during cardiac diastole -the pressure stores.

Blood flow through the circulatory system

Seven Sections

1. Heart as a pump; elastic arteries as pressure reservoirs
2. Cushioning vessels: small arteries convert the rhythmic pulse into a smooth flow.
3. Resistance vessels: arterioles (major), capillaries, and venules
4. Sphincter vessels
5. Exchange vessels: the true capillaries
6. Shunt vessels (Not found in all tissues)
7. Capacitance vessels: act as blood reservoirs - veins & venules

Regulation of flow through blood vessels

Blood vessel caliber, an important factor in the determination of resistance and capacitance, is actively regulated by neural and humoral mechanisms and passively affected by the pressure within it. Vasomotor refers to rhythmic oscillating changes in the caliber of the arterioles, metarterioles, and precapillary sphincters resulting from vasoconstriction or vasodilatation and venomotion. Venomotion affects capacitance, especially in the upright position.

Neural control of vasomotor tone

Vasomotor tone is the continuous, low-level activity of vascular smooth muscle fibers that maintain the tension of the vascular walls. It varies in different tissues, and is mainly dependent upon the rate of impulses from the sympathetic nerve fibers to the muscle cells. This tone is higher in skeletal muscles and splanchnic area blood vessels and

least in the heart, brain, and kidney. Vasomotor tone is the tension basically to maintain arterial blood pressure; increase in tone increases blood pressure; decrease in tone lowers blood pressure.

In order to maintain an adequate coronary and cerebral blood flow while supplying extra blood to the muscles during heavy exercise, blood pressure must be maintained or increased and blood shifted from the splanchnic and renal areas to the active muscles by changes in the resistance of these vascular beds. This is due to changes in the caliber of the blood vessels.

Sympathetic regulation of vasomotor & venomotor tone

Postganglionic sympathetic fibers from the thoracolumbar sympathetic ganglia provide innervation to all blood vessels, though the density of innervations varies in different tissues. Sympathetic fibers innervate smooth muscles in the principal arteries, small arteries, and terminal arterioles in tissues. Precapillary arterioles and metarterioles in skeletal muscles are also well innervated by sympathetic nerves. Innervated veins by sympathetic too respond by vasoconstriction. Vasoconstriction allows movement of large amount of blood towards the heart in emergencies, such as hemorrhage.

Only very few blood vessels are innervated by the parasympathetic, hence this system is less potent.

Norepinephrine Stimulation of Alpha Receptors

Norepinephrine released from most postganglionic sympathetic fibers reacts with alpha receptors in the skin, Splanchnic area, skeletal muscle, & kidneys to cause a strong vasoconstriction. The blood vessels of the heart and brain lack alpha receptors, consequently nor epinephrine is ineffective in these tissues.

Epinephrine stimulation of beta receptors

Epinephrine is released into the circulation after sympathetic stimulation of the adrenal medulla and it acts on beta receptors present in the blood vessels of the heart and

brain, causing vasodilatation, ensuring that these vital organs are not deprived of blood during stressful situations that induces vasoconstriction elsewhere.

Cholinergic sympathetic vasodilation

The blood vessels of the skeletal muscles also receive sympathetic cholinergic postganglionic fibers stimulating cholinergic receptors, resulting in vasodilatation, just prior to strenuous exercise, shunting blood to the muscles that will be most active.

Parasympathetic regulation of vasomotor activity

Postganglionic cholinergic parasympathetic fibers appear to be significant in few tissues; the genital erectile tissues (penis and clitoris) and clitoris glands, such as the salivary glands, where acetylcholine evokes production of vasodilator bradykinin,

Local regulation of blood flow

The regulation of blood flow through the microcirculation is influenced by neural factors as well as some provocative substances that modify vasomotor tone. Some of these vasoactive substances reach the tissues through the circulating blood and others are locally produced by the tissues themselves. Together the neural and vasoactive factors balance vasoconstrictor and vasodilation in specific vascular beds.

Hormonal substances

Epinephrine & Norepinephrine

Norepinephrine though present in small concentration is generalized vasoconstrictor; its effect is more important as a neurotransmitter at nerve endings. Epinephrine act either as a vasoconstrictor or as vasodilator depending on their concentration, the previous vasomotor tone, and the specific receptors present on the smooth muscle cells of a particular region. It is vasodilator in the skeletal muscle and liver and the heart, elsewhere it has a vasoconstrictor effect.

Peptides

The hypothalamic peptide vasopressin is vasoconstrictor. Angiotensin II found in blood is another very potent generalized vasoconstrictor. Damaged tissues produce histamine, which are an amine and a very potent vasodilator substance. Most of the histamine is released from mast cells and eosinophils. In damaged tissues histamine causes vasodilatation and a marked increase in capillary permeability and tissue edema. Many tissues, such as brain and the gastrointestinal tract release different peptides, such as glucagons.

Cholecystikin, secretin and vasoactive intestinal peptide (VIP):- These peptides cause vasodilatation. Another peptide bradykinin is very potent vasodilator and also increases capillary permeability. Bradykinin also cause release of local prostaglandin that act either as vasodilator or as vasoconstrictor. Serotonin, released by activated platelets, is a vasoconstrictor that also releases nor epinephrine from sympathetic nerve endings.

Locally produced vasoactive substances

Almost all of them are vasodilators, produced by actively metabolizing tissues, which themselves ensure increased blood flow in active tissues. These substances include: hydrogen, and potassium ions, inorganic phosphate, carbon dioxide, some intermediates of the kreb's cycle. Increased tissue tonicity and relative hypoxia too have vasodilator effects.

Myogenic control of blood flow

The smooth muscles present in the walls of the terminal arterioles of the microcirculation respond to changes in vascular pressure by vasomotion. Vascular distention induced by increased pressure in the arteriole, and increases their tone, resulting in vasoconstriction. Conversely, decreased arteriolar pressure is followed by relaxation of the smooth muscles and a consequent vasodilatation. The myogenic response is not present in all tissues.

Autoregulation of blood flow

No single factor from vasoactive substances, neural and myogenic control is responsible for the final regulation of blood flow through the microcirculation. The fine tuning regulation of blood flow depends upon different combinations of humoral and local vasoactive substances, changes in the proportion of vasoconstriction and vasodilatation, and balance between sympathetic and parasympathetic activity, plus the myogenic responses to changes in arterial blood pressure.

Autoregulation assures relatively adequate blood flow even when large fluctuations in blood pressure occur. Autoregulation depends upon the interaction of neural and humoral factors. An increase in blood pressure briefly increases blood flow through the tissues, but it will also rapidly remove tissue vasodilators and increase the oxygen supply.

All these factors result in vasoconstriction that reduces the flow of blood. A fall in blood pressure transiently decreases blood flow, increases metabolic and humoral accumulation of metabolic vasodilators, decreases oxygen content, and initiates the myogenic response of vasodilation.

Blood flow through the tissue increases and the increased venous return to the heart raises the cardiac output. Increased cardiac output causes an increase in arterial blood pressure.

The coronary circulation is an excellent example of auto regulation, whereby the volume of blood flowing through the heart is adapted to the need of cardiac muscle fibers. An increase in contractile force increases immediately coronary flow. When the stroke volume of the heart is increased, more blood is immediately pushed into coronary arteries at the same time that the blood is ejected into the aorta. The myocardium receives most of the blood during diastole. During ventricular systole, the contracting ventricles compress the small coronary vessels. At rest, the coronary circulation

receives about 5% of the total cardiac output; it increases four to five times during strenuous exercise.

Regulation of arterial blood flow

In the elastic arterial vessels the blood inflow is intermittent, that is, only during the systole of the cardiac cycle, whereas the outflow from the arterioles to the capillaries is continuous.

During the first part of ventricular systole, blood is rapidly ejected into the aorta/pulmonary artery, arterial blood pressure rises to a peak:- **SYSTOLIC BLOOD PRESSURE** (average =120 mm Hg; range from 105 -130 mmHg in a young adult). Then as the elastic arterial wall distends, the ventricles begin to relax (diastole) & the semi-lunar valves close due to pressure gradient. During diastole the aortic /pulmonary pressure continues to fall and as the elastic aorta recoils, blood is pushed to the periphery. The low point in the aortic /pulmonary pressure is diastolic pressure, about 80mm Hg in systemic circulation (range of 60 to 85 mm Hg in young adults), Pulse pressure is the difference between the systolic blood pressure (SBP) and diastolic blood pressure (DBP). At rest it is about 40 mm Hg; pulse pressure (PP) is increased when stroke volume (SV) Increased; a change in distensibility as in arteriosclerosis (loss of elasticity) of the arterial wall, will increase PP. Mean arterial blood pressure (MABP) increases with age and as a result of arteriosclerosis. $MABP = DBP + \frac{1}{3} \text{ pulse pressure} =$ about 100 mm Hg in young adults.

Higher brain centers, such as hypothalamus and cerebral cortex, coordinate the cardiovascular responses depending on the stimulus.

A stressful stimulus may result in the following autonomic changes:

- Shunting of blood to active skeletal muscles
- Restriction of blood flow to abdominal & pelvic viscera, & skin
- Increased rate & depth of respiration
- Increased sweating

These features are evident in fear, rage, or excitement. Regulation of ABP is accomplished by controlling cardiac output, total peripheral resistance, & blood volume. Mean ABP is the main driving force for propelling blood to the tissues. It has to be maintained for the following reasons:

- It must be high enough ensuring sufficient driving pressure in the capillaries where exchange of fluid occurs across the wall;
- Without sufficient pressure, brain & other tissues will not get enough blood flow, no matter what local auto regulation are made;
- This pressure must not be too high to create extra work-load for the heart & increase the risk of rupturing blood vessels.

The two determinants of ABP are cardiac output and total peripheral vascular resistance & number of factors that in turn, determine CO & TPR. Cardiac output primarily influences the SBP & the TPR is a major determinant for DBP.

Same neural & humoral factors are involved in short-term blood pressure regulation (minutes to hours) e.g., in exercise, postural changes, or sudden loss of blood. Long-term adjustments of ABP are probably based on balance between the blood volume and urinary volume, a balance that involves salt balance, aldosterone, & the renin-angiotensin system.

Control of cardiac output and factors affecting total peripheral resistance

MABP depends on CO & TPR

- CO depends on the stroke volume (SV & heart rate (HR))
- HR depends on the relative balance of parasympathetic, that lowers & sympathetic and epinephrine that increases HR.
- SV increases in response to sympathetic activation
- SV increases as venous return (VR) increases by means of Frank Starling's law of the heart (intrinsic auto regulation, or heterometric auto regulation)

- VR increases by sympathetic-induced venoconstriction. the skeletal pump, the respiratory pump, & the cardiac suction.
- The effective circulating blood volume too influences CO
- Short-term shift between vascular & interstitial fluid compartment
- Long- term: salt balance & water balance, which is hormonally controlled by aldosterone, vasopressin, and renin-angiotensin system
- Other determinants of MABP, TPR depends upon the radius (lumen) of all arterioles as well as on blood viscosity; arteriolar radius is more important
- Arteriolar radius is affected by local changes influenced by vasoactive metabolites (such as hypoxia, hyper apnea, acidity due to hydrogen ions, osmolality, temperature, bradykinin, histamine etc) that match blood flow with metabolic needs-intrinsic control
- Arteriolar radius is influenced by sympathetic activity (vasoconstrictor adrenergic fibers innervating arterioles)
 - An extrinsic control that increases arteriolar vasoconstriction to increase TPR and eventually increase ABP
 - arteriolar radius is controlled by hormones, vasopressin, angiotensin-II, potent vasoconstrictors and important in salt and water balance

Mean arterial blood pressure is constantly monitored by baroreceptors within the circulatory system. Short- term (within Seconds) adjustments are accomplished by alterations in cardiac output, total peripheral resistance, mediated by means of autonomic nervous system on the heart, Veins and arterioles. Long-term (Regulating minutes to days) control system involves adjustments of blood volume by restoring normal salt and water balance, through mechanisms that regulate urine output & thirst. The magnitude of blood volume has a profound effect on cardiac output and ABP.

The baroreceptor reflex is the most important mechanism for short term regulation of blood pressure the most important baroreceptors are located in the carotid sinus & aortic arch; they are sensitive to both change in MABP & PP. They constantly inform about the ongoing changes in BP in arterial wall in the form of action potentials. These

receptors are fine nerve endings present in the arterial wall that are stimulated by tension/stretch of the arterial wall evolved by blood pressure.

Vasomotor Center (VMC) consists of diffuse group of cells in the lower third of the pons and upper part of medulla.

The efferent pathway is the ANS.

- Vasoconstrictor area lies in the medulla and cells in this region continuously fire sympathetic vasoconstrictor nerves to maintain vasomotor tone (arteriolar tone)
- Vasodilator area is not clearly defined and may be acting chiefly to inhibit the vasoconstrictor area, there by allowing vasodilatation.

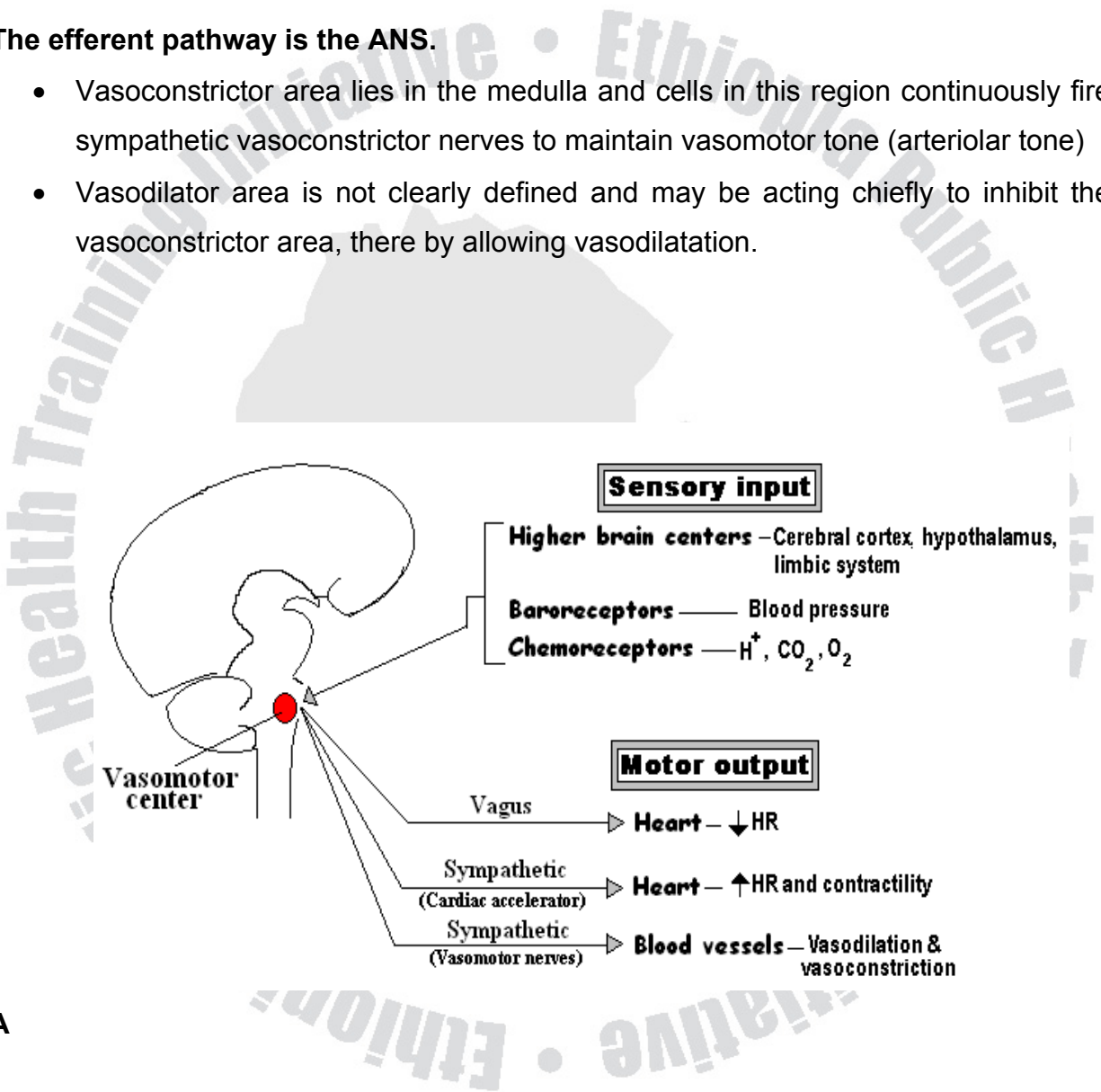

A

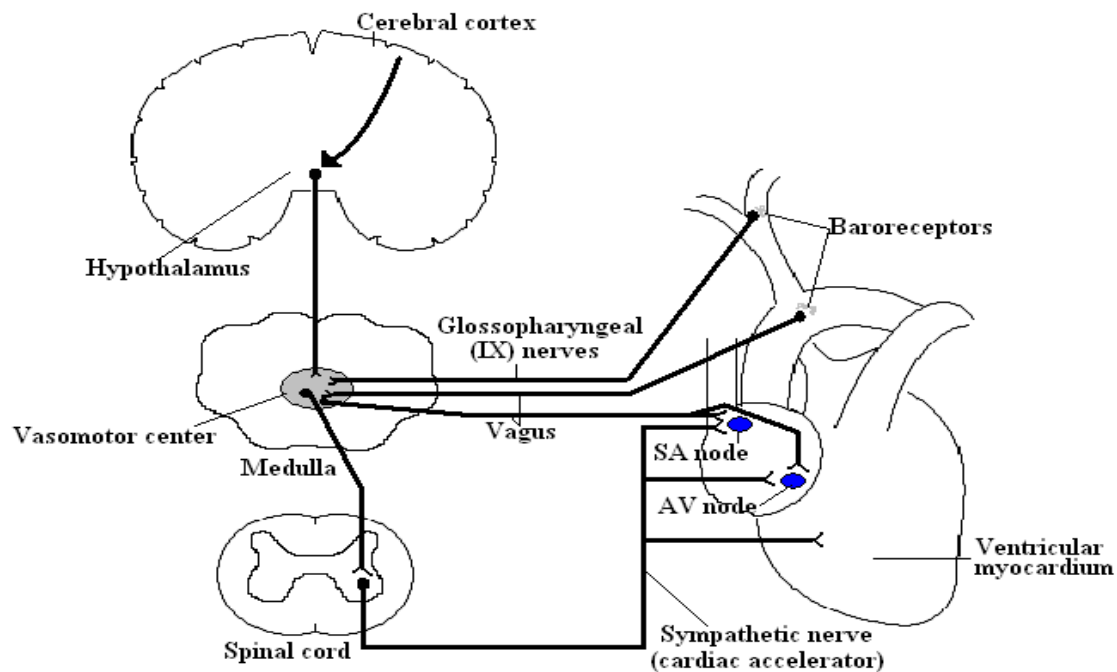

Figure 56, A&B. Vasomotor center: its location, input from the higher centers and output to the effector.

The cardiac center also consists of two functionally different areas. The cardiac inhibitory center lies in medulla and includes the dorsal nucleus of vagus. It slows the heart rate and decreases the contractility of the heart through the impulses sent through the efferent fibers of the vagii.

These areas functions reciprocally. They are completely autonomous. They are regulated by higher hypothalamus and cerebral cortical regions and in turn, the heart and blood vessels, are capable of some intricate auto regulation.

Cardiovascular reflexes (see fig.56)

Peripheral input. Cardiovascular control areas receive information from many peripheral inputs, including arterial baroreceptors, mechanoreceptors in the heart and

lungs, arterial chemoreceptors (Carotid and aortic bodies), and input from skeletal muscles.

The high-pressure baroreceptors are the most important source of peripheral input. Afferent pathway from bar receptors to cardiac center:

Carotid sinus nerve (nerve of Herring) leads to the gloss pharyngeal nerve, IX cranial nerve. The baroreceptor afferents also lead to suprapontine structures: the reticular formation, limbic system, and the fronto-orbital cortex.

Baroreceptor reflex: If for any reason, ABP becomes elevated above normal. The carotid sinus and aortic arch baroreceptors increase the rate of firing in their afferent nerve. Upon being informed by increased afferent that ABP has become too high, the cardiac center responds by decreasing sympathetic and increasing parasympathetic activity to the cardiovascular system. These efferent signals decrease heart rate, decrease stroke volume, and produce arteriolar and venous dilation, which in turn lead to decrease in cardiac output and decrease in total peripheral resistance, with a consequent decrease in blood pressure back towards normal. Conversely, when blood pressure falls below normal baroreceptor activity decreases, inducing the cardiovascular center to increase sympathetic cardiac and vasoconstrictor nerve activity, while the parasympathetic output is decreased. This efferent activity pattern leads to an increase in heart rate and cardiac output coupled with arteriolar and venous vasoconstriction. These changes result in an increase in both cardiac output and total peripheral resistance, producing an elevation in blood pressure back towards normal.

Suprapontine cardiovascular centers

Limbic System:-The Hypothalamus and Amygdala. The structures that control autonomic nervous system in response to emotion are of importance in the regulation of cardiovascular responses with changes in respiration, metabolism, and generalized excitement, such as occur in “ALARM REACTION” of an animal in danger stimulation of the ventral hypothalamus results in many complex “ defense reactions” of an animal to danger or threat of danger. These include: sympathetic cholinergic vasodilatation in

skeletal muscle which promote immediate increase in blood flow to the muscles to be used, sympathetic vasoconstriction elsewhere which increase blood pressure, increase heart rate and contractility, increased catecholamines production, increased respiratory rate, piloerection (in animals). All these reactions prepare the animal for “Flight-or-fight” and are examples of short-term adjustment of ABP.

Stimulating another area of the hypothalamus, the opposite reactions occur. The heart slows (bradycardia), blood pressure falls, and a state similar to fainting occurs. There appears to be a very strong inhibition of the sympathetic cardiovascular centers.

After stimulating of the amygdala, both pressure & depressor responses have been observed both the hypothalamus and amygdala are capable of strongly influencing all circulatory reflex responses.

Higher Centers: - The fronto-orbital cortex modulates hypothalamus integration of cardiovascular activity. The most important is to help the hypothalamus resetting the responses to the baroreceptor reflexes. This resetting is important for the maintenance of an adequate high blood pressure during exercise or response to danger. Immediately lowering ABP would decrease blood flow to active tissue and muscle activity could not be sustained. Resetting may be a change in the threshold of the baroreceptors. By resetting baroreceptors, ABP can be maintained at much higher steady state during exercise than at rest.

The role of the cortex in these control mechanism is not still clear other than that if it is removed there is impairment of cardiovascular responses. Emotional stresses may stimulate the hypothalamus through cortical pathways. In some it may cause fainting probably due to powerful stimulation, through the hypothalamus, of the medullary cardioinhibitory and vasodilator centers.

Therefore, areas higher than the pons, i.e., reticular formation, hypothalamus and amygdala, and the fronto-orbital cortex centers modulate the excitability of the vagal and sympathetic effectors nerves, permitting a fine degree of control over cardiac activity. Other reflexes and responses influencing blood pressure. Some reflexes and

responses influence blood pressure though they primarily are concerned with the regulation of other functions. Some of these influence ABP away from their normal values temporarily, overriding the baro- receptor reflex to achieve a particular goal.

These reflexes include the following:

- Left atrial volume (low pressure baroreceptors) and hypothalamic osmoreceptors are primarily important in water and salt balance in the body; thus, they affect the long-term regulation of ABP by controlling the plasma volume (blood volume).
- Chemoreceptors (carotid and aortic bodies) located in the carotid and aortic arteries are sensitive to hypoxia or low levels of pH in the blood. The chemoreceptor function is to reflexly increase respiration to bring more oxygen or to blow off acid-forming carbon dioxide, but they also reflexly increase blood pressure by sending stimulatory impulses to the cardiovascular centers.
- Cardiovascular responses associated with certain behavior and emotions are mediated through the cerebral cortex-hypothalamus pathways and appear to be pre-programmed
 - Sympathetic fight-or-flight responses
 - Characteristic marked increase in cardiac output and blood pressure associated with sexual response.
 - Pronounced cardiovascular changes accompanying exercise
 - Sustained increase in skeletal muscle blood flow
 - Significant increase in cardiac output
 - Decrease in total peripheral resistance due to widespread vasodilation
 - Modest increase in ABP

It happens with adaptation of exercise and in early stages

Hypothalamic control over coetaneous arterioles for the purpose of temperature regulation, takes precedence over maintaining ABP. Blood pressure may fall when eliminating excess heat from the body even though baroreceptors reflex is for coetaneous vasoconstriction.

Vasoactive substances released from endothelial cells play a role in the regulation of ABP - endothelium-derived relaxing factor (EDRF) which is nitric oxide (NO).

Long-term Regulation of blood pressure: Long-term regulation of blood pressure involves many factors in addition to the integrated neural control of cardiovascular reflexes. The kidneys are the most important mediators in the long-term control of BP since renal function is concerned with fluid balance. Changes in body fluid volume affect venous return, cardiac output and hence ABP. (see fig. 57)

Kidney & Blood Pressure Regulation

Long-term regulation of ABP depends on maintaining normal blood volume that is accomplished mainly by the kidneys. Kidneys have the ability to regulate the blood flow through them. When arterial blood pressure falls, the resulting fall in blood flow causes retention of water and sodium chloride, which in turn increases blood volume, venous return, cardiac output, and ABP and renal blood flow.

Conversely, when arterial blood pressure rises, renal blood flow increases, kidney excretes greater amount of water & NaCl, blood volume falls, venous return reduces, and the ABP and renal blood flow decline as cardiac output is diminished. These negative feedback mechanisms controlling ABP are closely related with the 'renin-angiotensin-aldosterone' system of the kidney, which in turn involves several hormonal and neural mechanisms.

Renin-Angiotensin System:-

Renin does not affect blood pressure directly. It is a protease acting on angiotensinogen to produce angiotensin-I, which is changed to angiotensin-II by an enzyme in the lungs. Angiotensin -II is responsible for the changes in water and salt balance and vasoconstriction that regulate BP and volume and composition of the extracellular fluid in the long run.

Mechanisms regulating renin secretion:- Renin is secreted by the Juxtaglomerular cells found in the walls of renal afferent arterioles. Its secretion is controlled by the following factors:

- The juxtaglomerular cells not only secrete rennin but also act as baroreceptors responding to these changes in afferent arterioles blood pressure. A fall in systemic blood pressure, reduces the pressure in the afferent arterioles, reduces the wall stretch, and JGC respond by secreting rennin.
- In the distal tubule are present specialized cells known as 'macula densa', that act as chemoreceptors, responding to changes in the amount of sodium filtered and /or chloride delivered into the renal tubules. The macula densa responds to sodium excretion and by some unknown mechanism, feedback this information to the juxtaglomerular cells, causing a rise in rennin secretion, and corresponding retention - a befitting response to increased sodium excretion in the urine.
- Increased sympathetic stimulation increases rennin secretion. It is an indirect effect on the JG cells due to arteriolar vasoconstriction. Circulating catecholamines too would produce rennin secretion.
- Angiotensin, itself exerts a 'negative feedback' effect on rennin secretion.

Effects of Angiotensin - II

- Angiotensin-II is the most potent vasoconstrictor, but very short-acting. Its vasoconstrictor effect on arteriolar smooth muscles causes a sharp rise in peripheral resistance and hence arterial blood pressure.
- Angiotensin – It is the most potent stimulus for the release of aldosterone by the zona glomerulosa cells of the adrenal cortex. Aldosterone acts on the distal renal tubule to decrease the amount of NaCl excreted in to the urine. Sodium and water in blood increase. Thus blood volume rises, blood pressure increases, & rennin secretion is inhibited.
- Angiotensin-II stimulates hypothalamus areas controlling thirst and drinking behavior to increase the water intake
- Angiotensin-II stimulates 'Vasomotor centers in the brain' to increase blood pressure via stimulating sympathetic and inhibiting parasympathetic pathways.

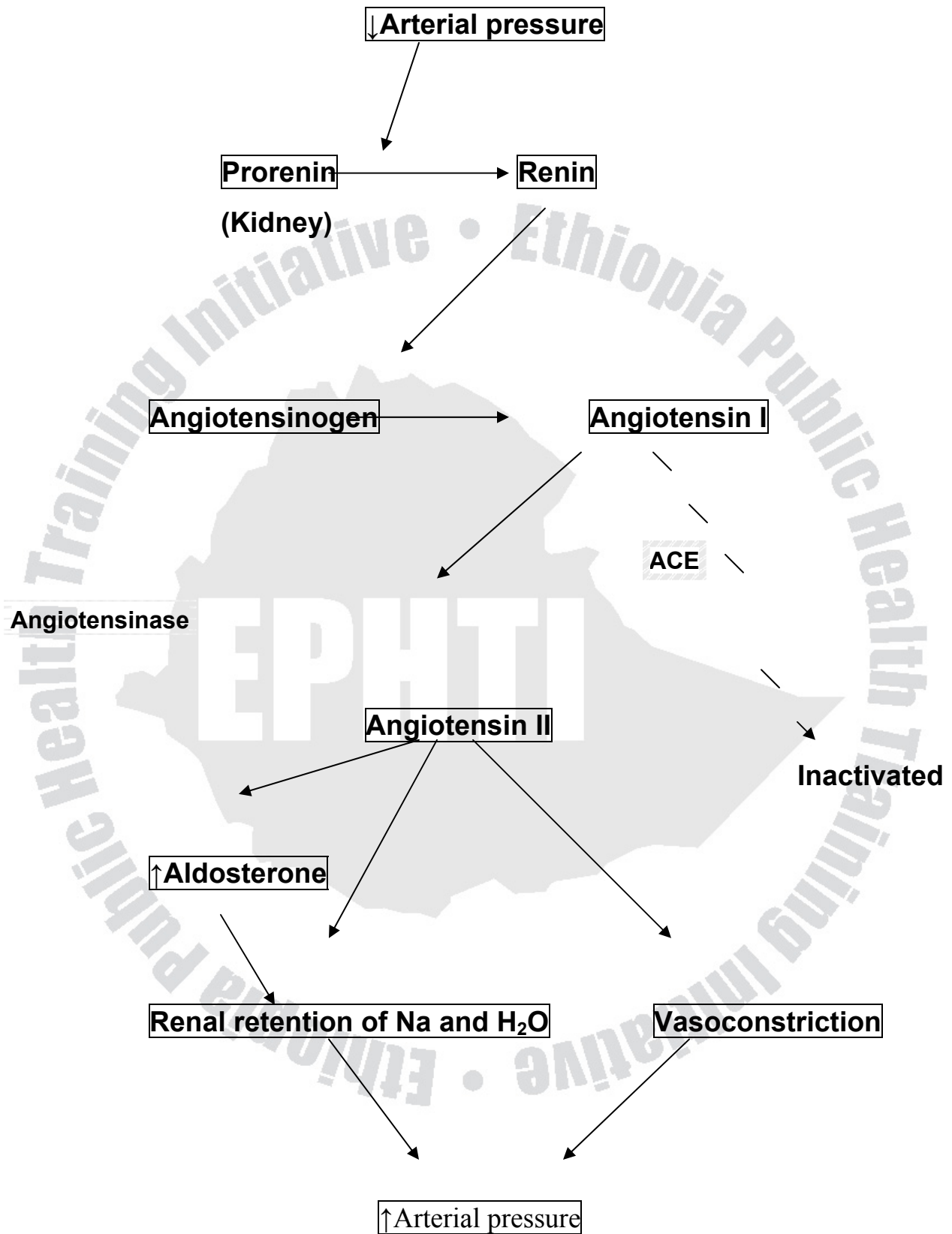

Figure 57. Role of the renin-angiotensin system in arterial pressure control

Circulatory Shock

'Shock' is a popular term used by the layperson to describe a sudden and severe setback due to any reason. But circulatory shock or 'cardiovascular collapse' is characterized by a reduction in circulatory blood volume and results in inadequate tissue perfusion. Circulatory shock is the final common pathway for a number of potentially lethal clinical events including severe hemorrhage, extensive trauma or burns, large myocardial infarction, massive pulmonary embolism, and microbial sepsis.

Classification

1. Hypovolemic shock

This is due to an absolute reduction in blood volume.

- (a) Loss of blood: The fluid lost may be blood and may be lost from the body, as in hemorrhage. Hemorrhage generally leads to shock if more than 15 to 20% of the blood volume has been lost. With smaller losses, the compensatory mechanisms of the body are generally able to prevent shock.
- (b) Loss of water and electrolytes: Alternatively, the fluid lost may be water and electrolytes, as in diarrhea and vomiting.
- (c) Loss of plasma: The fluid lost may be plasma, and lost to the circulation but not from the body, as in burns. In burns, plasma is lost from capillaries, the permeability of which is increased. The plasma collects in the interstitial space but cannot circulate.

2. Cardiogenic shock

Cardiogenic shock results from myocardial pump failure.

- (a) Myocardial infarction
- (b) Cardiomyopathy
- (c) Inadequate coronary blood flow and ischemia

3 Septic shock

Septic shock is caused by systemic microbial infection.

4. Neurogenic shock

Shock occasionally results without any loss of blood volume. Instead, the vascular capacity increases so much that even the normal amount of blood becomes incapable of adequately filling the circulatory system. One of the major causes of this is sudden loss of vasomotor tone throughout the body, causing especially massive dilation of the veins. The resulting condition is known as neurogenic shock. It is caused by:

- (a) Deep general anesthesia
- (b) Spinal anesthesia
- (c) Brain damage

5. Anaphylactic shock

Some hypersensitivity reactions can lead to release of histamine or other substances, which produce vasodilation as well as increase in capillary permeability. This histamine, in turn, causes

- (a) Increase in vascular capacity
- (b) Dilatation of arterioles
- (c) Greatly increased capillary permeability

Table 18. Three major types of shock

Type of shock	Clinical examples	Principal mechanisms
Cardiogenic	<ul style="list-style-type: none"> ▶ Myocardial infarction ▶ Ventricular rupture ▶ Arrhythmia ▶ Cardiac tamponade ▶ Pulmonary embolism 	<ul style="list-style-type: none"> ▶ Failure of myocardial pump due to intrinsic myocardial damage or extrinsic pressure or obstruction to outflow
Hypovolemic	<ul style="list-style-type: none"> ▶ Hemorrhage ▶ Fluid loss (e.g., vomiting, diarrhea, burns, trauma) 	<ul style="list-style-type: none"> ▶ Inadequate blood or plasma volume
Septic	<ul style="list-style-type: none"> ▶ Overwhelming microbial infections (endotoxic shock, gram-positive septicemia, or fungal sepsis) 	<ul style="list-style-type: none"> ▶ Peripheral vasodilation and pooling of blood ▶ Endothelial activation/injury ▶ Leucocyte-induced damage ▶ Disseminated intravascular coagulation

Stages of circulatory shock

1. Nonprogressive shock

In this stage the normal circulatory compensatory mechanisms will eventually cause full recovery without help from outside therapy. In the early nonprogressive stage of shock, various neurohumoral mechanisms help maintain cardiac output and blood pressure. These include baroreceptor reflexes, release of catecholamines, activation of renin-angiotensin axis, ADH release, and generalized sympathetic stimulation. The net effect is tachycardia, peripheral vasoconstriction, and renal conservation of fluid.

2. Progressive stage

This is characterized by tissue hypoperfusion and onset of worsening circulatory and metabolic imbalances. If the underlying causes are not corrected, shock passes imperceptibly to the progressive phase, during which

- (a) There is widespread tissue hypoxia
- (b) In the setting of persistent oxygen deficit, intracellular aerobic respiration is replaced by anaerobic glycolysis with excessive production of lactic acid
- (c) The resultant metabolic lactic acidosis lowers the tissue pH and blunts the vasomotor response
- (d) Arterioles dilate, and blood begins to pool in the microcirculation
- (e) Peripheral pooling not only worsens the cardiac output but also puts endothelial cells at risk of developing anoxic injury with subsequent DIC
- (f) With widespread tissue hypoxia, vital organs are affected and begin to fail
- (g) Clinically, the patient may become confused and the urinary output declines.

- Irreversible stage

In this stage the shock has progressed to such an extent that all forms of known therapy are inadequate to save the person's life, even though, for the moment, the person is still alive. Unless the progressive stage is intervened, the process eventually enters an irreversible stage.

- (a) Widespread cell injury is reflected in lysosomal enzyme leakage, further aggravating the shock state
- (b) Myocardial contractile function worsens, in part because of nitric oxide (NO) synthesis
- (c) If ischemic bowel allows intestinal flora to enter the circulation, endotoxic shock may also be superimposed
- (d) At this point, the patient has complete renal shutdown due to acute tubular necrosis

(e) Despite heroic measures the downward clinical spiral almost inevitably culminates in death.

Signs and symptoms of circulatory shock

- (1) Increased thirst
- (2) Body temperature
 - In hypovolemic and cardiogenic shock: Decreased body temperature
 - In septic shock: Increased body temperature
- (3) Increased HR
- (4) Decreased urine output
- (5) Restlessness and apprehension

Physiology of treatment in shock

Replacement therapy

Blood and plasma transfusion

Dextran solution

Treatment with sympathomimetic drugs

Other therapies

Treatment by the head-down position

Oxygen therapy

Treatment with glucocorticoids

Hypertension

In spite of regulatory mechanisms, the blood pressure frequently shows persistent elevation, which is called hypertension. Some rise in blood pressure with age is accepted as physiological. A rule of the thumb is to consider the blood pressure as normal if it is less than $100 + \text{Age in years}$ mmHg. However, many specialists have evidence to believe that rise in blood pressure with age is a price we have to pay for our lifestyle, specially the high salt content of our diet. Some experts assert that if no

additional salt is added to our food throughout life, the blood pressure will stay constant throughout our life. Since this hypothesis cannot be widely tested on human beings at present stage of our civilization, we have to accept some rise in blood pressure as a part of the aging process. Although the change is gradual, and there is no sharp dividing line between the normal and high blood pressure, an arbitrary dividing line is required for clinical use. The arbitrary upper limits are 140 and 90 mmHg for systolic and diastolic blood pressure respectively. A mean arterial pressure greater than 110 mmHg under resting conditions usually is considered to be hypertensive.

Adverse effects of hypertension

The lethal effects of hypertension are caused mainly in three ways:

- (1) Excess workload on the heart leads to early development of congestive heart disease, coronary heart disease, or both, often causing death as a result of heart attack.
- (2) Cerebral infarct ("stroke"): The high pressure frequently ruptures a major blood vessel in the brain, followed by death of major portions of the brain; this is a cerebral infarct. Clinically it is called a "stroke." Depending on what part of the brain is involved, a stroke can cause paralysis, dementia, blindness, or multiple serious brain disorders.
- (3) Kidney failure: High pressure almost always causes multiple hemorrhages in the kidneys, producing many areas of renal destruction and, eventually, kidney failure, uremia, and death.

Types of hypertension

I. Essential hypertension (see fig. 58)

Causes

The causes of essential hypertension are complex and largely unknown. It is known, however, that a number of factors interact in producing long-term elevations in blood pressure; these factors include:

Hemodynamic
Neural
Humoral
Renal

Arterial hypertension occurs when the relationship between blood volume and total peripheral resistance is altered. For many of the secondary forms of hypertension, these factors are reasonably well understood. For example, in renovascular hypertension, renal artery stenosis causes decreased glomerular flow and decreased pressure in the afferent arteriole of the glomerulus. This (1) induces renin secretion, initiating angiotensin II-induced vasoconstriction and increasing peripheral resistance and (2) through aldosterone mechanism increases Na reabsorption and, therefore, blood volume. Several factors may then be postulated to contribute to the primary defects in essential hypertension, encompassing both subtle genetic and environmental influences:

- (a) Reduced renal sodium excretion
- (b) Vasoconstrictive influences
- (c) Environmental factors

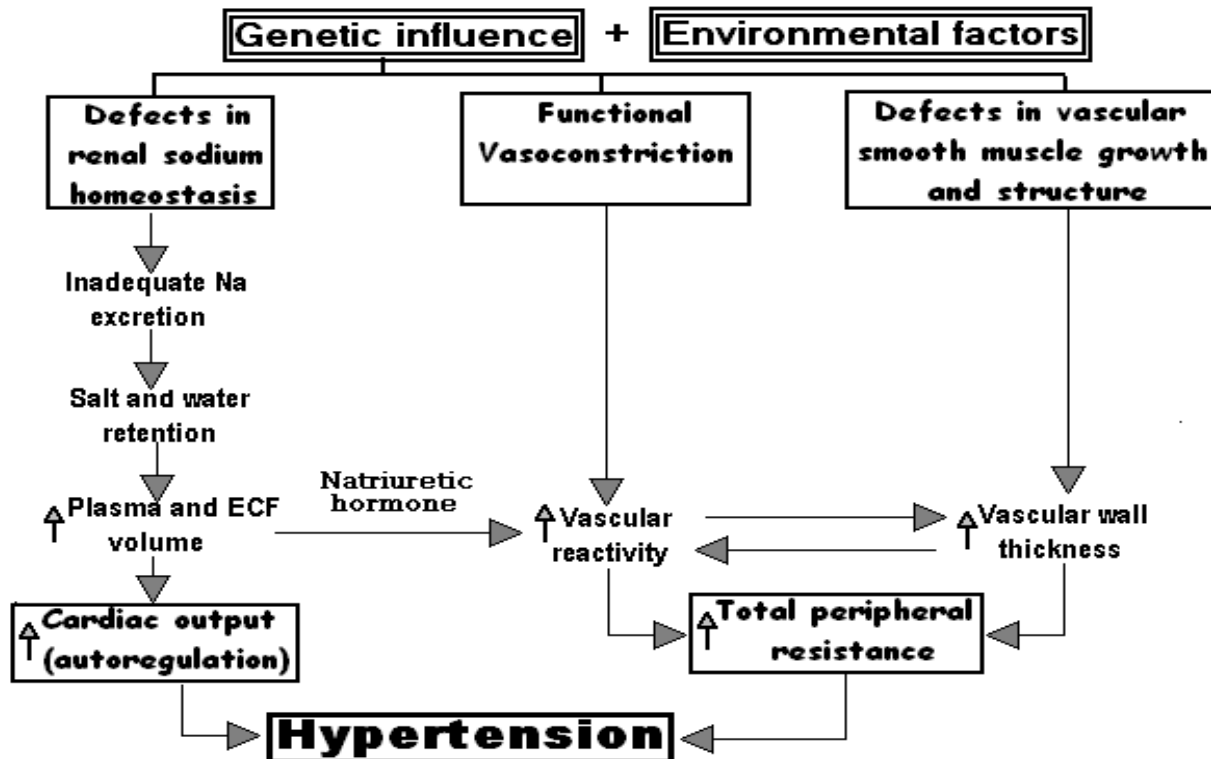

Figure-58 : Hypothetical scheme for the pathogenesis of essential hypertension

Risk factors

- (1) Family history
- (2) Advancing age
- (3) Race
- (4) High salt intake
- (5) Obesity
- (6) Excess alcohol consumption
- (9) Use of oral contraceptive drugs

II. Secondary hypertension

Only 5% to 10% of hypertensive cases are currently classified as secondary hypertension- that is, hypertension due to another disease condition. The disease states that most frequently give rise to secondary hypertension are:

- (1) Renal disease
- (2) Vascular disorders
- (3) Endocrine disorders
- (4) Acute brain lesion.

Types and causes of hypertension

I. Essential hypertension (90% to 95% of cases)

II. Secondary hypertension

Renal

- Acute glomerulonephritis
- Chronic renal disease
- Polycystic disease
- Renal artery stenosis
- Renal vasculitis
- Renin-producing tumors

Endocrine

- Adrenocortical hyperfunction (Cushing syndrome, primary aldosteronism)
- Exogenous hormones (glucocorticoids, estrogen, sympathomimetics)
- Pheochromocytoma
- Acromegaly
- Hypothyroidism (myxedema)
- Hyperthyroidism
- Pregnancy-induced

Cardiovascular

- Coarctation of aorta
- Polyarteritis
- Increased intravascular volume
- Increased cardiac output
- Rigidity of the aorta

Neurologic

Psychogenic

Increased intracranial pressure

Sleep apnea

Acute stress, including surgery



References

Davenport HW. The ABC of acid-base chemistry

Dougherty WM. Introduction to haematology

Gordon AS. Blood cell physiology

Platte WR. Color atlas and Textbook of haematology

Berne RM and MN Levy. Cardiovascular Physiology; 6th ed St Louis: C.V. Mosby, 1991.

Folkow B and E Neil. Circulation

Guyton AC, CE Jones and TG Coleman. Circulatory physiology, cardiac output and its regulation.

Randall W. Neural regulation of the heart

Smith JJ and JP Kampine. Circulatory physiology, the essentials.

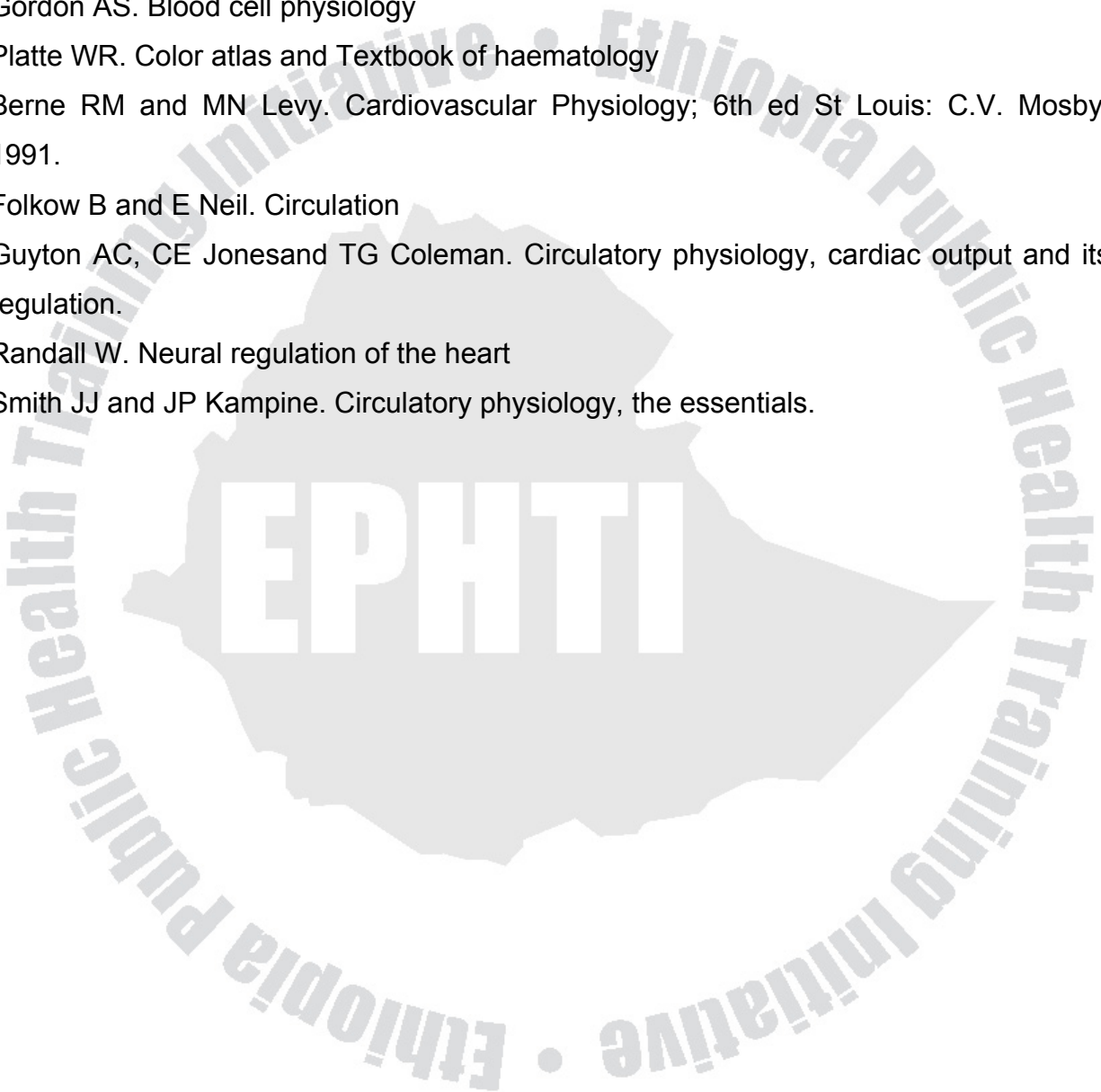

Questions

Describe the functional structure of haemoglobin and its degradation related to bilirubin metabolism.

Discuss the regulation of erythropoiesis

Describe the functions of different types of leukocytes

Discuss leucopoiesis

What are physiological responses in hemostasis? - Role of platelets; Intrinsic, extrinsic and final common pathway in coagulation; Fibrinolysis.

Discuss the balance of clotting and anti-clotting mechanism

Describe conduction tissue of the heart and origin and spread of cardiac impulse

Describe the events of cardiac cycle

Discuss cardiac cycle:- Factors influencing cardiac output ; venous return; Factors influencing heart rate, myocardial contractility and stroke volume.

Discuss the regulation of arterial blood pressure: Short term control; long term control; role of hormones.

Discuss microcirculation of blood flow: Myogenic and metabolic autoregulation

GLOSSARY

Acetylcholine: The neurotransmitter released at neuromuscular junction/ synapse.

Acetylcholine esterase: enzyme present in motor end plate membrane of skeletal muscle that inactivates acetylcholine.

Active transport: Active carrier-mediated transport against concentration gradient across plasma membrane

Adaptation: a reduction in receptor potential in spite of sustained stimulus

Adenosintriphosphate (ATP): the body's common energy, terminal phosphate bond provide energy to power cell activities

After hyperpolarization: transient hyperpolarization that occurs at the end of action potential.

Albumin: the smallest and most abundant plasma protein, which binds and transports water, insoluble substances in the blood and contributes predominantly to plasma colloidal osmotic pressure.

Anemia: a reduction below normal in oxygen carrying capacity of the blood.

Antibody: An immunoglobulin produced by a specific activated B-lymphocyte against particular antigen.

Antigen: A large complex molecule that triggers a specific immune response against itself when it gains entry in to the body.

Aorta: the large vessel that carries blood from the left ventricle.

Aortic Valve: A one-way valve that permits flow of blood from the left ventricle in to the aorta during ventricular emptying but/prevents the back flow into the ventricle during ventricular diastole.

Arterioles: the highly muscular high-resistance vessels the caliber of which can be altered to control blood flow to each of the various tissues.

Artery: a vessel that carries blood away from the heart.

Atherosclerosis: A progressive degenerative arterial disease that leads to gradual blockage of affected vessel, there by reducing blood flow through them.

Atrial natriuretic peptide (ANP): hormone released from the cardiac atria that promotes urinary loss of sodium.

Atrioventricular node: a small bundle of specialized cardiac cells located at the junction of the atria and ventricle serving as the only site of the electric contact between the atria and ventricle.

Atrioventricular valve: Valve that permits the flow of blood from the atria to the ventricle during filling of the heart but prevents back flow from the ventricles to the atria during the emptying of the heart.

Atrium (Atria, plural): an upper chamber of the heart that receives blood from the veins and transfers it to the ventricle.

Autonomic Nervous system: the portion of the different division of the peripheral nervous system that innervates smooth muscles and cardiac muscle and exocrine glands; composed of two divisions: the sympathetic and parasympathetic nervous system.

Axon hillock: the first portion of a neuronal axon, the site of action potential in most neurons.

Baroreceptor reflex: an autonomically mediated reflex response that influence the heart and blood vessels to oppose change in mean arterial blood pressure.

Bundle of His: a tract of specialized cardiac cells that rapidly transmits an action potential down the interventricular septum of the heart.

Baroreceptor: receptor located within the circulatory system that monitors blood pressure.

B- lymphocytes (B cells): white blood cells that produce antibodies against specific targets.

Basophils: white blood cells that release histamine in allergic responses and heparin that removes fat particles from the blood.

Body system: a collection of organs that perform related functions essential for survival of the whole body, e.g. the digestive system.

Calmodulin: intracellular calcium-binding protein that upon activation is important in smooth muscle contraction.

Cardiac cycle: one period of systole and diastole.

Cardiac output (CO): the volume of blood pumped by each ventricle each minute, equals stroke volume time heart rate.

Cardiovascular control center: the integrating center located in the medullas of the brain stem that controls mean arterial blood pressure.

Catecholamines: the chemical classification of the adreno-medullary hormones.

Channels: Small water filled pathways through the plasma membrane providing highly selective passages for ions.

Cholesterol: a type of fat molecule that serves as a pressure for steroid hormones and bile salts and is a sterilizing component of the plasma membrane.

Cholinergic fibers: nerve fibers that release acetylcholine as their neuro-transmitter.

Circulatory shock: when mean arterial blood pressure falls so low that adequate blood flow to the tissues can no longer be maintained.

Congestive heart failure: the inability of the cardiac output to keep pace with the body, needs for blood delivery with blood damming up in the veins behind the failing heart.

Controlled variable: Some factors that can vary but controlled in a steady state

Coronary artery disease: Atherosclerotic plaque formation and narrowing of the coronary artery that supply that heart muscle.

Cross-bridges: myosin molecule's globular head interacting with actin molecules during muscle contraction.

Cytokines: All chemicals other than antibodies that are secreted by lymphocytes.

Cytoplasm: the portion of the cell not occupied by the nucleus

Cytosol: portion of the cell not occupied by organelles

Cytotoxic T-cells: Cells that destroy host cells bearing antigens such as virus infected cells, cancer cells etc.

Depolarization: a reduction of membrane action potential from resting membrane potential towards 0 mV.

Diastole: the period of cardiac relaxation and filling.

Effector organs: the muscles or granular tissue innervated by nerves that bring about the desired effect such as secretion or movement.

Endoplasmic reticulum: Membrane network of fluid-filled tubules synthesizing proteins and lipids.

Endothelial derived relaxing factor (EDRF): a local chemical mediator CNO, nitric oxide, released from the endothelia cells lining an arteriole that diffuses locally to cause relaxation of the arteriolar smooth muscle in the vicinity.

Endothelium: the thin single celled layer of epithelial cells that lines the entire circulatory system.

End-plate potential (EPP): The gradual receptor potential that occurs at motor end plate of skeletal muscle in response to binding of acetylcholine

End-systolic volume (ESV): the volume of blood in the ventricle at the end of systole, when emptying is complete.

Eosinophils: white blood cells that are important in allergic response in combating parasitic infections.

Erythropoiesis: Red cell production by the bone marrow

Erythropoietin: the hormone released from the kidneys in response to hypoxia; stimulating Erythrocyte production.

Excitable Tissue: Tissue capable of producing electrical signals when excited includes muscle and nerve.

Exocytosis: secretion by cells.

Feed forward mechanism: a response designed to prevent an anticipated change in a controlled variable.

Fibrinogen: soluble plasma protein that is changed to thread like molecules that form the blood clot.

First messenger: an extracellular chemical messenger that binds with the membrane receptor and activates an intracellular second messenger to achieve desired cellular response.

Frank-Starling law of the heart: intrinsic control of the heart, such that increased venous return resulting in increased end-diastolic volume leads to an increased strength of contraction and increased stroke volume; that is, the heart normally pumps out all of the blood returned to it.

Golgi complex: a cellular organelle that processes raw materials into finished product and sorts and directs for final destination.

Graded potential: a local change in membrane potential that occurs in varying grades of magnitude; serves as short distance electric signals in Excitable Tissues.

Granulocytes: Leukocytes that contain granules such as neutrophils, eosinophils and basophils.

Heart failure: an inability of the cardiac output to keep pace with the body's demands for supplies and for removal of wastes.

Helper T- cells: T- cells enhancing the activity of other immune response effector cells.

Hematocrit: Percentage of blood cell volume

Hemoglobin: A large iron-bearing molecule transporting O₂ and CO₂.

Hemostasis: the stoppage of bleeding from injured vessel.

Hyperpolarization: an increase in membrane potential from resting potential, becoming even more negative.

Hypertension: sustained, above normal mean arterial blood pressure.

Hypotension: sustained, below normal mean arterial blood pressure.

Hypoxia: insufficient oxygen at cellular level.

Integrating center: A region that determines efferent output based on processing of afferent input

Interleukin-I: Multipurpose chemical mediator released from macrophages

Interleukin-II: a chemical mediator secreted by T-helper cells that augment the activities of all T cells.

Internal environment: The body extracellular fluid region having plasma and interstitial fluid.

Left ventricle: the heart chamber that pumps blood in to the systematic circulation.

Lymphocytes: white blood cells that provide immune defense against target cells.

Lysosome: Cell organelles having powerful hydrolytic enzymes that destroy unwanted material within the cell.

Macrophage: large tissue bound phagocytic cells

Mean arterial blood pressure: the pressure responsible for driving blood forward through the arteries in to the tissues throughout the cardiac cycle.

Membrane potential: caused by charges with inside being electronegative to electropositive outside

Motor end plate: Portion of skeletal muscle membrane having ACH receptors.

Motor neurons: neurons that innervate skeletal muscles

Motor unit: is motor nerve plus all of the muscle fibers innervated.

Multi-unit smooth muscle: muscle with multiple discrete cells independent of each other

Myelinated fiber: neuronal axon covered at regular intervals with insulative myelin.

Myocardial ischemia: in adequate blood supply to the heart tissue.

Myocardium: Cardiac muscle with in the heart wall.

Negative feed: a regulatory mechanism in which a change in the controlled variable triggers a response that opposes the change, thus maintaining a steady state of the variable.

Oponins: Chemicals that link bacteria to phagocytic cells.

Paracrine: a local chemical messenger exerting effects only on nearby cells in the immediate vicinity of secretion.

Phagocytosis: a type of endocytosis

Plaque: a deposit of cholesterol and other lipids, perhaps calcified, in the thickened, abnormal smooth muscle with in blood vessels as a result of altherosclersis.

Plasma membrane: a protein -lipid bilayer that encloses each cell.

Platelets: cells participating in hemostasis.

Positive feedback: a regulatory mechanism in which the inputs and outputs in control system continue to enhance each other so that the variable moves further from steady state value.

Purkinje fibers: Small terminal fibers that extend from the bundle of it is and rapidly transmit an action potential throughout the ventricular myocardium.

Refractory period: Period when an activated membrane is refractory to further stimulation preventing action potential from spreading backward.

Repolarization: return of membrane potential to resting potential following depolarization.

Ribosomes: special plexus that synthesize proteins.

Right atrium: the heart chamber that receive venous blood from the systemic circulation.

Right Ventricle: the heart chamber that pumps blood in to the pulmonary circulation.

Saltatory condition: propagation of action potential in a myelinated fiber with the impulse jumping from one node of Ranvier to another.

Sarcoplasmic reticulum: reservoir of ionic calcium

Second messenger: an intracellular chemical messenger activated by extracellular chemical that triggers preprogramed biochemical events, resulting in control of cellular activity.

Signal transduction: The sequence of events, which carry signals from first chemical messenger conveyed to the cell.

Sinoatrial (SA) node: a small specialized autorhythmic region in the right atrial wall of the heart that has the fastest rate of the spontaneous depolarization and serves as the normal pace maker of the heart.

Stroke volume (SV): the volume of blood pumped out of each ventricle with each contraction or beat of the heart.

Synapse: specialized junction between two neurons.

T-lymphocytes: White cells involved in immune response.

Vasoconstriction: the narrowing of a blood vessel lumen as a result of contraction of the vascular circular smooth muscle.

Vasodilatation: the enlargement of a blood vessel lumen as a result of relaxation of the vascular circular smooth muscle.

Vein: A vessel that carries blood toward the heart.

Venous return: the volume of blood returned to each atrium per minute from the veins.

Ventricle: a lower chamber of the heart that pumps blood in to the arteries.

ABBREVIATIONS

ECG: electro cardiogram

EDV: end diastolic volume

EPSP: Excitatory post-synaptic potential

IPSP: inhibitory post-synaptic potential



CHAPTER FOUR

RESPIRATORY SYSTEM

Learning objective.

After this chapter the student is expected to:

- relate the structural organization of the respiratory system to its function
- describe the functional importance of the intrapleural fluid, the parietal and visceral pleura
- know the structural and functional features that distinguish the respiratory zone of the airways from the conducting zone
- define and describe the alveolar-capillary unit
- know the definitions fractional concentrations (of dry gas) and partial pressure of gases
- know the normal values of partial pressure of oxygen and carbon dioxide in arterial and mixed venous blood
- know how exchange of gases occur between the blood and tissues
- know the control mechanisms involved in respiration

Introduction

The major functions of the respiratory system can be divided in two categories: respiratory and non-respiratory. The first function is to carry out gas exchange. Metabolizing tissues utilize oxygen and produce carbon dioxide. The respiratory system must obtain oxygen from the environment and must eliminate carbon dioxide produced by cellular metabolism. These processes must be coordinated so that the demand for oxygen is met and so that the carbon dioxide that is produced is eliminated. The respiratory system is well designed to carry out gas exchange in an expeditious manner.

The respiratory system is also involved in non-respiratory functions. It participates in maintaining acid-base balance, since increase in CO_2 in the body lead to increased H^+ the lungs also metabolize naturally occurring compounds such as angiotensin I,

prostaglandins and epinephrine. The lungs are also responsible for protecting the body from inhaled particles.

Function of the respiratory system:

Function of the respiratory system is the exchange of O_2 and CO_2 between the external environment and cells of the body.

Functional anatomy of the respiratory system

Functionally, the respiratory air passages are divided into two zones: a conductive zone and a respiratory zone. The airway tree consists of a series of highly branched hollow tubes that decrease in diameter and become more numerous at each branching. Trachea, the main airway in turn branches into two bronchi, one of which enters each lung. Within each lung, these bronchi branch many times into progressively smaller bronchi, which in turn branch into terminal bronchioles analogous to twigs of a tree. The terminal bronchioles redivide to form respiratory bronchioles, which end as alveoli, analogous to leaves on a tree. (see fig. 59)

Conducting zone

The conducting zone includes all of the anatomical structures through which air passes before reaching the respiratory zone. The conducting zone includes all of the anatomical structures through which air passes before reaching the respiratory zone. The conducting zone carries gas to and from the alveoli, i.e., it exchanges air between the alveoli and atmosphere. The conducting zone of the respiratory system, in summary consists of the following parts:

Mouth→ nose→ pharynx→ larynx→ trachea→ primary bronchi→ all successive branches of bronchioles including terminal bronchioles.

Functions

1 Warming and humidification of the inspired air

Regardless of the temperature and humidity of the atmosphere, when the inspired air reaches the respiratory zone it is at a body temperature of 37° C (body temperature) and it is saturated with water vapor. This ensures that a constant internal body temperature will be maintained and that delicate lung tissue will be protected from desiccation.

2. Filtration and cleaning: Mucus secreted by the cells of the conducting zone serves to trap small particles in the inspired air and thereby performs a filtration function. This mucus is moved along at a rate of 1-2cm/min by cilia projecting from the tops of the epithelial cells that line the Conducting zone. There are about 300 cilia per cell that bend in a coordinated fashion to move mucus toward the pharynx, where it can either be swallowed or expectorated. As a result of this filtration function, particles larger than about 6µm do not enter the respiratory zone of the lungs. The importance of this disease is evidenced by the disease called black lung, which occurs in miners who inhale too much carbon dust and therefore develop pulmonary fibrosis. The cleansing action of cilia and macrophages in the lungs is diminished by cigarette smoke.

3. Distribute air to the gas exchange surface of the lung.

Respiratory zone

The respiratory zone includes the respiratory bronchioles (because they contain separate out pouching of alveoli) and the alveoli. Alveoli are tiny air sacs, having a diameter of 0.25-0.50mm. There are about 300-500 million alveoli in a lung. The numerous numbers of these structures provides a large surface area (60-80m² or 760ft²) for diffusion of gases.

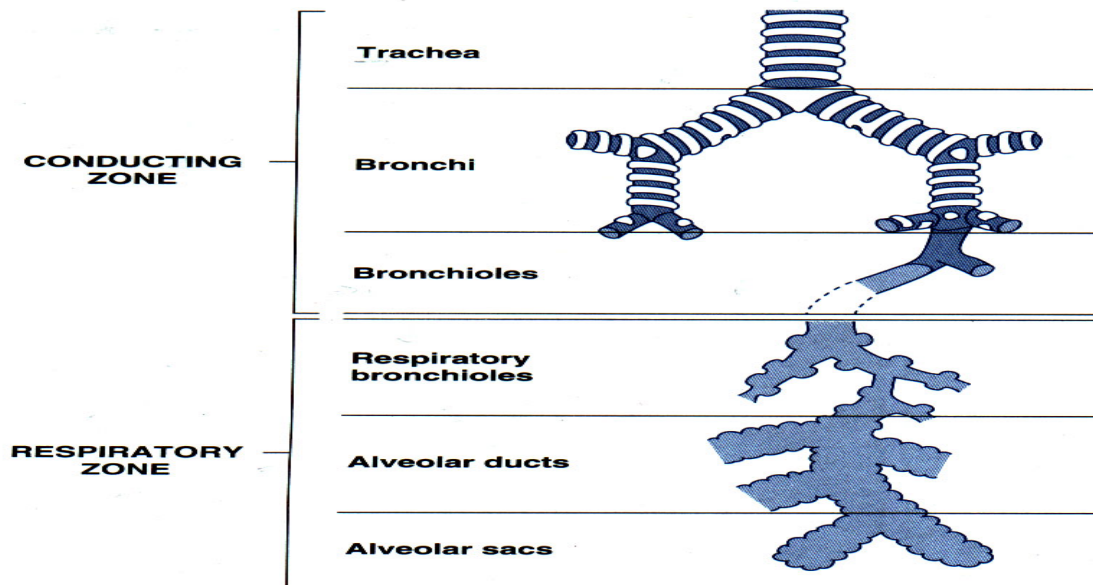

Figure 59. Structure of the airway

Pulmonary blood flow.

Pulmonary blood flow is the cardiac output of the right heart. It is delivered to the lungs via the pulmonary artery. Pulmonary capillaries form dense network around the alveoli. Pulmonary blood flow is not distributed evenly in the lungs because of gravitational effects. When a person is standing, blood flow is lowest at apex (top) and higher at base (bottom) of lungs. When a person is in supine (lying down), position gravitational effects disappear. As in other organs, regulation of blood flow is accomplished by altering arteriolar resistance

Bronchial circulation is the blood supply to the conducting airways & is a small fraction of total pulmonary blood flow.

Lung Volumes and Capacities

Lung Volumes. (see figure 60)

Tidal volume (TV) - volume expired or inspired with each breath at rest

Normal TV is 350-500 ml and includes volume that fills alveoli plus the volume that fills airways

Inspiratory reserve volume (IRV)-additional volume of air inspired on maximal forced inspiration at the end of normal tidal inspiration.

Normal IRV=3000ml

Expiratory reserve volume (ERV): Volume of air still be expired by forceful expiration after the end of normal tidal expiration.

Normal value= 1100ml

Residual volume (RV): Volume that remains in the lungs after maximum expiration, normal=1200ml.

RV cannot be measured with spirometry

Lung capacities- addition of 2 or more volumes

Inspiratory capacity (IC)=TV+ IRV= 3500ml

Functional residual capacity (FRC) =ERV+RV =2400ml

Vital capacity (VC) =IRV+ERV=4700ml

Total lung capacity (TLC) =includes all lung volumes and capacity
=VC+RV=590ml

Helium dilution and body plethysmograph methods are used to measure FRC.

Measurement of lung volumes. Most are measured with spirometer. Subject sits and breathes into and out of the spirometer displacing a bell. Volumes displaced are recorded on calibrated paper (figure 57). V_C is volume in lungs after maximal inspiration.

Forced vital capacity (FVC) is total volume of air forcibly expired after maximal inspiration.

Volume forcibly expired in 1sec is FEV_1 (FEV = forced expiratory volume)

FVC and FEV_1 are useful indices of disease. Ratio of FEV_1 to FVC (FEV_1/FVC) is used to differentiate among pulmonary diseases. In normal person, $FEV_1/FVC= 0.8$ (80%), meaning

80% of VC can be forcibly expired in 1 second. In restrictive lung diseases (e.g. Fibrosis), both FEV_1 and FVC are reduced, but ratio of FEV_1/FVC may not change or

even may increase. In obstructive lung disease (e.g. asthma), FEV₁ is reduced more than FVC and ratio of FEV₁/FVC is decreased. (see fig. 61)

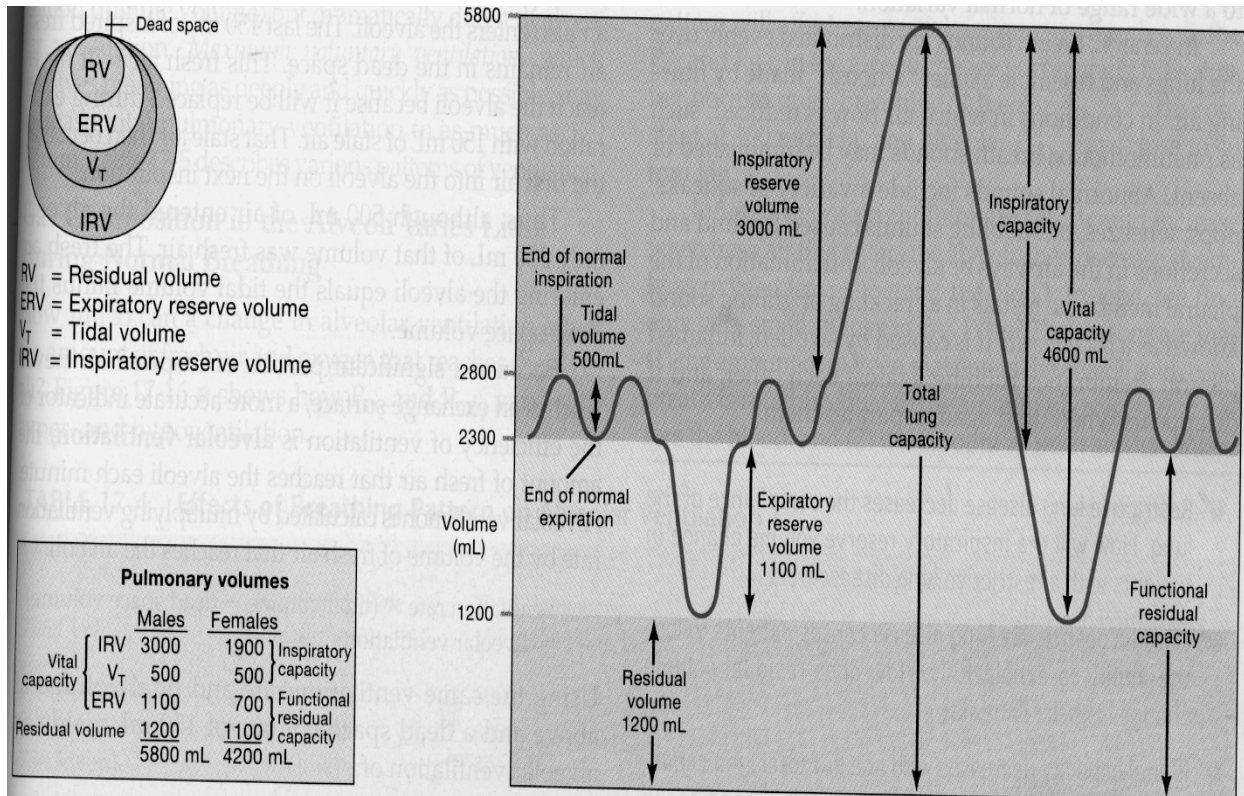

Figure 60. Lung volumes and capacities.

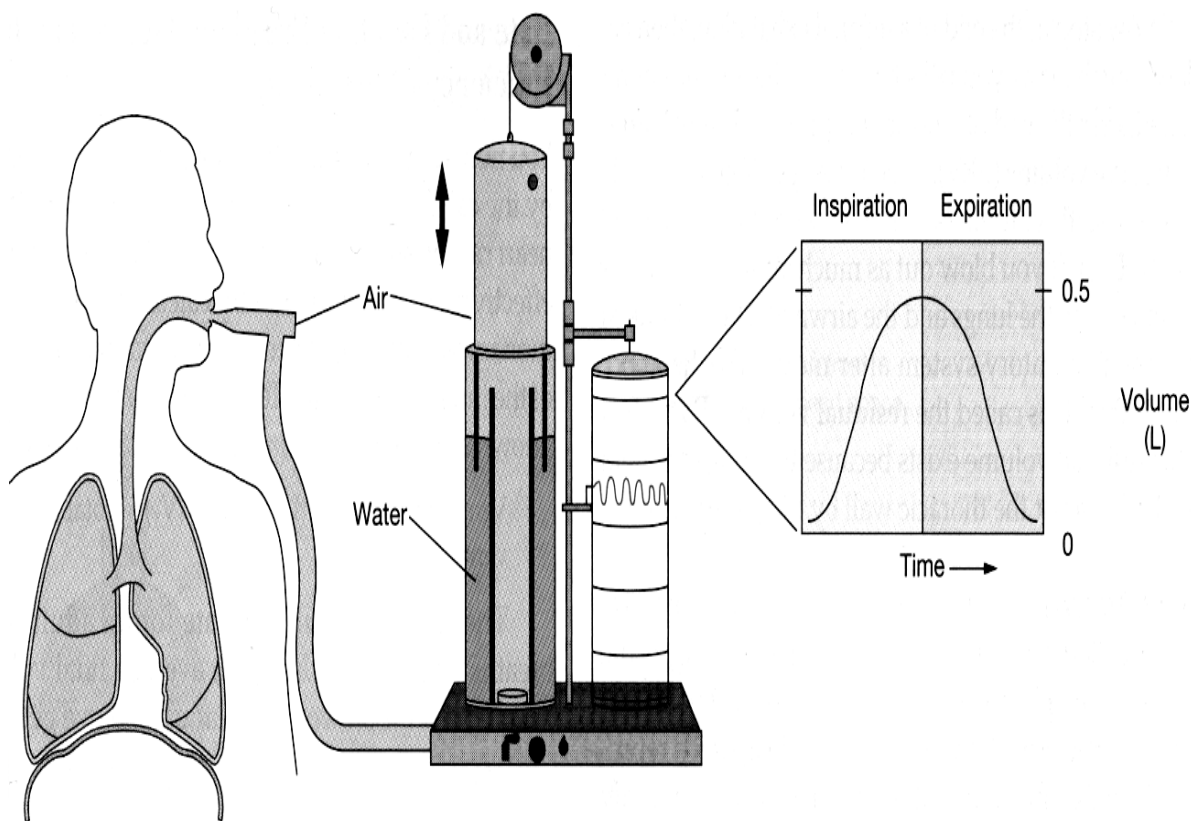

Figure 61. Measurement of lung volumes and capacities. Note that FRC and RV can't be measured by spirometer alone

Dead space: The volume of the airways and lungs that does not participate in gas exchange

Anatomic dead space: Volume of the conducting airways (does not include respiratory bronchioles and alveoli). If TV is 500ml, the entire volume does not reach alveoli for gas exchange. A portion fills conducting airways; this is ~ 150ml (dead space vol.) in TV of 500ml.

Physiologic dead space is volume of lungs that does not participate in gas exchange (wasted ventilation)

Physiologic dead space includes the anatomic dead space plus a functional dead space in the alveoli, (i.e. alveoli that do not participate in gas exchange). The functional dead space can be thought of as the alveoli that do not participate in gas exchange. The most important reason that the alveoli do not participate in gas exchange is an imbalance or

inequality of ventilation and perfusion in which ventilated alveoli are not perfused by capillary blood.

In normal person, physiologic dead space is nearly equal to the anatomic dead space where alveolar ventilation and blood flow are well matched.

If physiologic dead space is greater, there is imbalance of ventilation and perfusion.

Ventilation rates: Volume of air moved into and out of the lungs per unit time.

Minute ventilation = $V_T \times$ breaths /min

Where V_T =tidal volume (ml)

Alveolar ventilation = minute ventilation corrected for the physiologic dead space

$V_A = (V_T - V_D) \times$ breaths/min

Where

V_A = alveolar ventilation (ml/min)

V_T = Tidal volume (ml)

V_D = Physiologic dead space (ml)

Mechanics of breathing:

Muscles used for breathing:

Muscles of inspiration: The diaphragm is the most important inspiratory muscle. When diaphragm contracts, abdominal contents are pushed downward and the ribs are lifted upward and outward. These changes increase intrathoracic volume and lowers intrathoracic pressure. This initiates flow of air into the lungs. During exercise, when breathing frequency and TV increases, external intercostals muscles and accessory muscles are used for more vigorous inspiration.

Muscles of expiration: Expiration is normally passive. During exercise or in diseases, in which airway resistance is increased (e.g. asthma) expiratory muscles are used such as abdominal muscles which compress abdominal cavity and push diaphragm up. Internal intercostals muscles pull ribs downward and inward.

Compliance and elastance.

Definition: Change of volume per unit change of pressure ($\Delta V/\Delta P$). Compliance describes distensibility. In respiration, compliance of the lungs and chest wall are

important. Compliance of lung and chest wall are inversely correlated with their elastic properties (elastance)

Changes in lung compliance: Increase in lung compliance may occur due to loss of elastic fibers (e.g. emphysema, old age). Decrease in lung compliance increases the tendency of lung to collapse, e.g. in fibrosis

Surface tension of alveoli and surfactant:

Small size of alveoli is difficult to keep them open because of surface tension.

Surfactant line alveoli and reduce surface tension. Thus surfactant keeps alveoli open.

Atelectasis- collapsed alveoli due to reduced surfactant.

Surfactant is synthesized by Type II alveolar cell. Surfactant is lacking in premature infants, causing neonatal respiratory distress syndrome.

Breathing cycle.

Normal breathing cycle is shown in figure 62. Breathing cycle is divided into 3 phases

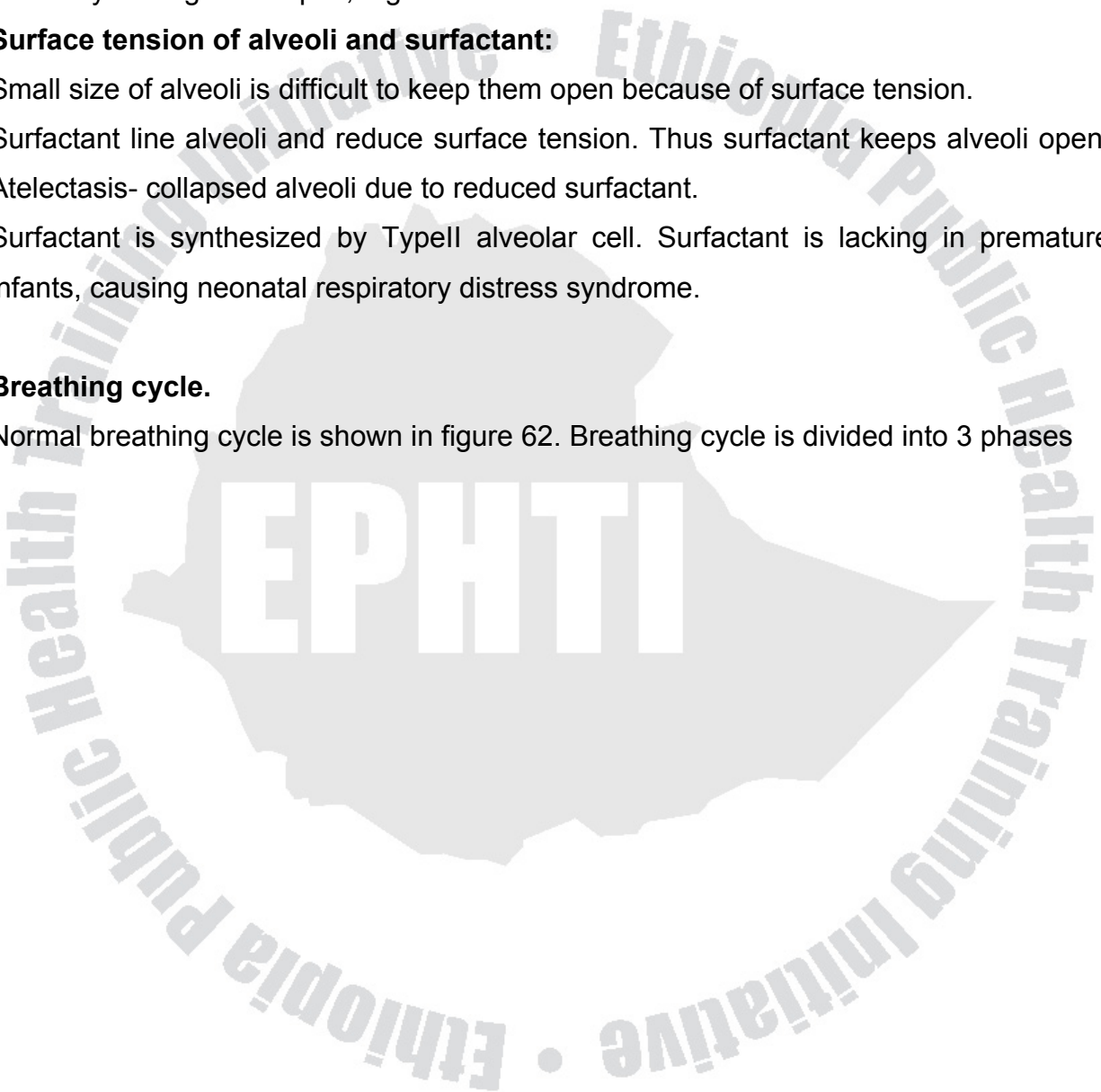

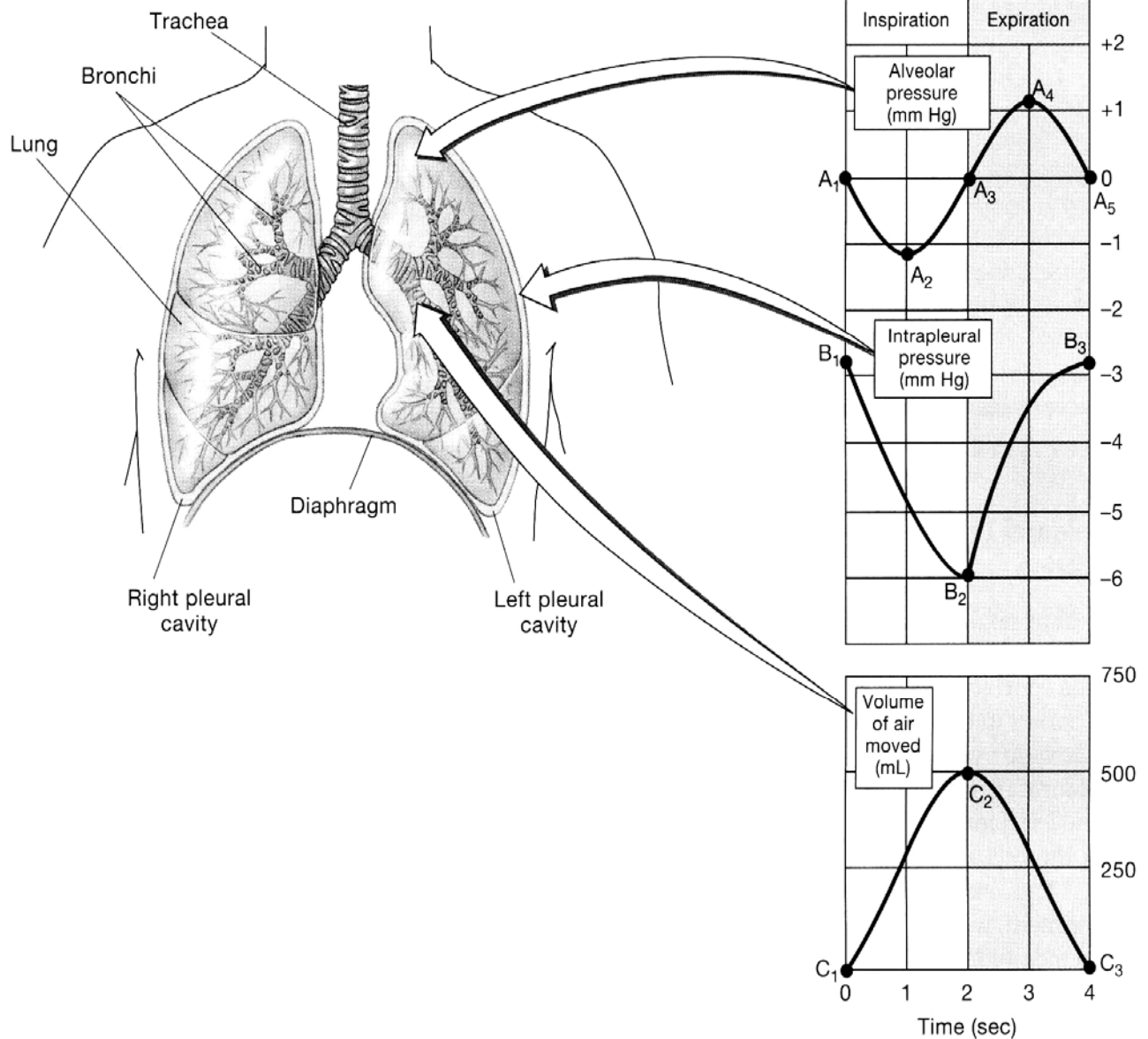

Figure 62. Volumes and pressures during the normal breathing cycle. Intrapleural and alveolar pressure are given in reference to atmospheric pressure

Rest. This is a period between breathing cycles. No air is moving into or out of the lungs. Alveolar pressure equals atmospheric pressure. Intrapleural pressure is negative ($\sim -5\text{cmH}_2\text{O}$) because opposing forces of lungs trying to collapse and chest wall trying to expand creates negative pressure in intrapleural space. The expanding force on the

lungs and airways at rest is + 5cmH₂O (alveolar or airway pressure minus intrapleural pressure)

Inspiration. The diaphragm contracts, causing volume of thorax to increase. Both airway and alveolar pressure becomes negative (i.e. less than atmospheric). Now pressure gradient is created between atmosphere, airways and alveoli. Air flows into the lungs until the pressure

gradient is dissipated. Intrapleural pressure becomes even more negative than at rest. The reason is as lung volume increases, elastic recoil strength of lungs increases.

Airway and alveolar pressure becomes negative as volume of thorax increase.

The two effects together cause intrapleural pressure to be more negative (~ -8cmH₂O).

Expiration: Expiration is normally passive. Alveolar pressure becomes positive (higher than atmospheric) because the elastic forces of the lung compress air in the alveoli. When alveolar pressure is greater than atmospheric, air flows out of lungs. Following expiration, volume in the lung decreases and intrapleural pressure returns to its resting volume (i.e. -5cmH₂O). Pneumothorax occurs when air is introduced into intrapleural space (e.g. hole by sharp object). In such a case there is no counterbalancing expanding force, thus lung collapses.

Work of breathing.

Refers to energy expended to:

- Expand elastic tissues of chest wall and lungs (compliance work)
- Overcome viscosity of inelastic structures of chest wall and lungs (tissue resistance work).
- Move air against resistance of airways.(airway resistance work)

Work of breathing accounts 2-3% of body's total energy expenditure.

Alveolar gas exchange

Gas exchange in the respiratory system refers to diffusion of oxygen and carbon dioxide in the lungs and in the peripheral tissues. Oxygen is transferred from alveolar gas into pulmonary capillary blood and, ultimately it is delivered to the tissues, where it diffuses from systemic capillary blood into the cells. Carbon dioxide is delivered from the tissues

to venous blood, (to pulmonary capillary blood), and is transferred to alveolar gas to be expired.

Gas laws.

At sea level, barometric pressure (P_B) = 760mmHg, and percentage of gas at dry air is 78% N_2 , 21% O_2 , 1% inert gas and 0.04% CO_2 .

Dalton's law of partial pressure states that each gas contributes to the total pressure in direct proportion to its relative concentration.

Partial pressure of any gas can therefore be calculated.

$$P_X = P_B \times F$$

P_X = partial pressure of gas (mmHg)

P_B = barometric pressure (mmHg)

F = fractional concentration of gas

Thus P_{N_2} (at sea level) = ~ 600 mmHg

PO_2 (at sea level) = 160mmHg

As air traverses the conduction system to enter the gas exchange area, temperature and humidity of gas approaches body temp and 100% humidity. The partial pressure (P_X) of gas in the alveolus changes.

Thus, $P_X = (P_B - P_{H_2O}) \times F$

P_{H_2O} = water vapors pressure at $37C^0$ (47mmHg)

Henry's law is used to convert the partial pressure of gas in the gas phase to concentration in the liquid phase (e.g. in blood)

(it does not include gas in bound form (e.g. gas bound to hemoglobin or to plasma protein).

Henry's law states that the actual concentration of dissolved gas in a liquid is equal to the partial pressure of the gas in contact with the liquid multiplied by the solubility coefficient of the gas in that particular liquid.

Thus, $C_x = P_x \times \text{solubility}$

Where

C_x = conc. of dissolved gas (ml gas/100 ml blood)

P_x = Partial pressure of gas (mmHg)

Solubility = solubility of gas in blood, ml gas/100ml blood/mmHg.

Eg. The solubility of O_2 is 0.003ml/100ml blood /mmHg

Diffusion of gases –Flick’s law

Transfer of gases across capillary wall is by simple diffusion.

Rate of transfer by diffusion is directly proportional to driving force, diffusion coefficient and surface area available for diffusion, but inversely proportional to thickness of membrane barrier.

Thus:

$$V_x = \frac{DA\Delta P}{\Delta x}$$

Where V_x = volume of gas transferred

D = diffusion coefficient of the gas

A = surface area

ΔP = partial pressure difference of the gas

ΔX = thickness of the membrane

Two special points regarding diffusion of gases are:

- ΔP is driving force for diffusion of a gas across the membrane (not concentration difference)

For example, if. P_{O_2} (partial pressure of O_2) of alveolar air = 100mmHg and P_{O_2} of mixed venous blood = 40mmHg,

ΔP of O_2 = (100-40) = 60mmHg

- D is combination of diffusion coefficient (which depends on molecular weight) and solubility of the gas. For example, D for CO_2 = 20 times higher than D for O_2 . Therefore, CO_2 diffuses 20 times faster than O_2

Lung diffusion capacity (DL):

DL (Vol./mmHg/min/pair of lungs) is volume of a gas that diffuses through the respiratory membrane each minute with a pressure difference of 1mmHg. DL takes time into account because, time is required for gas to combine with protein (e.g. O₂ with Hb).

Example for normal lung:

DL for O₂=21 ml/mmHg/min. at rest

DL for CO₂, is very high, it is not easy to measure because of its lipid solubility. In disease condition DL changes predictably. Emphysema destructs alveoli, thus decrease surface area and, DL decreases. In Pulmonary edema or fibrosis, diffusion distance increases (membrane thickness or interstitial volume increases) and DL decreases. In anemia, DL decreases because Hb decreases (N.B. DL includes protein binding component). During exercise, DL increases because additional capillaries are perfused with blood, which increases surface area for gas exchange. (see fig. 63)

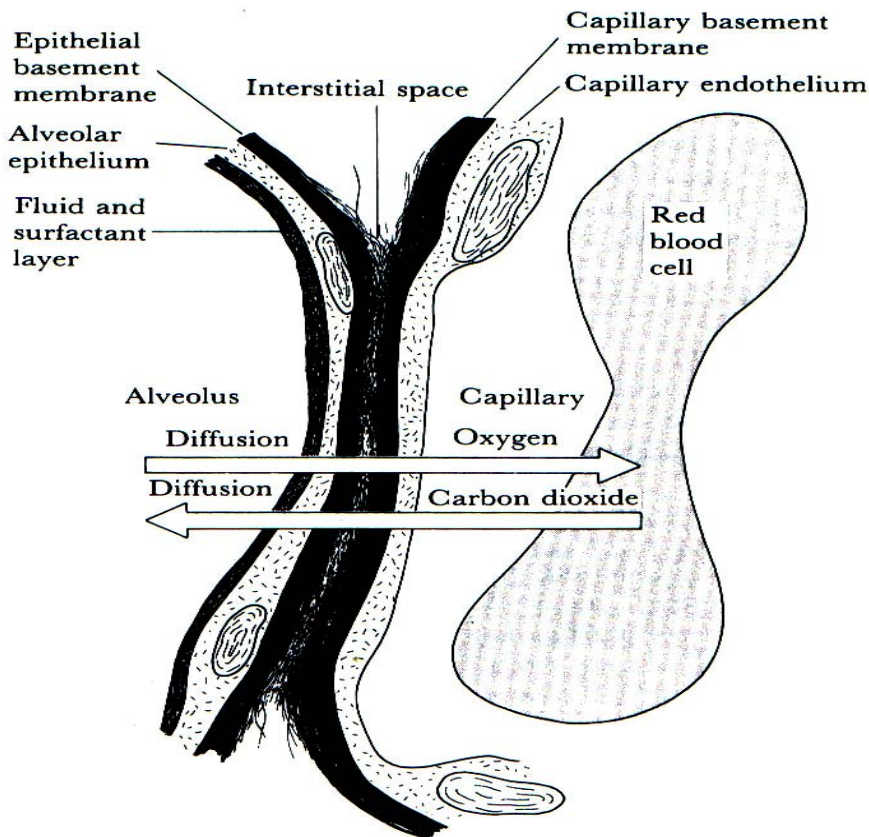

Figure 63. Ultra structure of the respiratory membrane where diffusion occurs.

Forms of gases in solution:

In alveolar air, gases are expressed in partial pressure. In solution (e.g. blood), gases are carried in additional forms. Total gas concentration in solution = dissolved gas + bound gas + modified gas

Dissolved gas: For a given partial pressure, the higher the solubility of gas the higher the concentration in solution. Of gases in inspired air, only N₂ is carried in solution

Bound gas:

O₂, CO₂, and CO are bound to protein in blood

O₂ and CO₂ are bound to hemoglobin inside RBC

CO₂ binds to hemoglobin in RBC and to plasma proteins

Chemically modified gas:

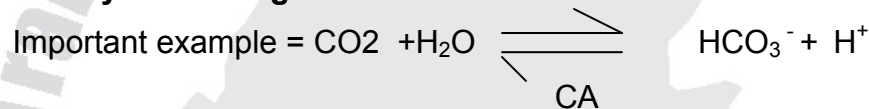

CA= carbonic anhydrase (enzyme in RBC)

Gas transport in the lung:

Pulmonary capillaries are perfused with blood from right heart. This blood is mixed venous blood. Gas exchange then occurs between alveolar gas and pulmonary capillary. O₂ diffuses from the alveoli into pulmonary capillary blood, CO₂ diffuses from capillary blood into alveolar gas (see figure 64)

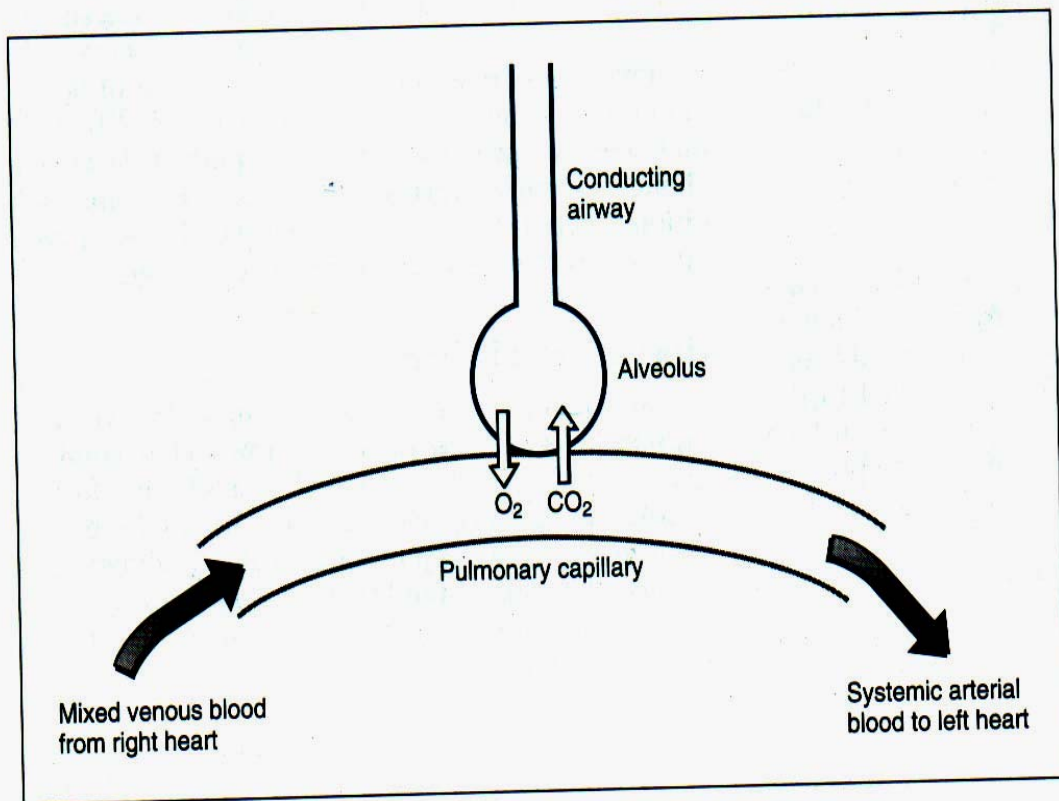

Figure 64. Schematic diagrams of an alveolus and pulmonary capillary. Mixed venous blood enters the pulmonary capillary, O_2 is added to pulmonary capillary blood and CO_2 is removed.

In dry inspired air (at sea level):

$$P_{O_2} = 160 \text{ mmHg} (760 \times 0.21)$$

$$P_{CO_2} \approx 0 \text{ mmHg}$$

In humidified tracheal air – P_{O_2} is reduced, CO_2 is “diluted” by water vapor

$$\text{Thus } P_{O_2} = 150 \text{ mmHg} (760 \text{ mmHg} - 47 \text{ mmHg}) \times 0.21$$

$$P_{CO_2} = 0$$

In alveolar air – P_{aO_2} (Partial pressure of O_2 in alveoli) = 100 mmHg. This is less than inspired air and $P_{CO_2} = 40 \text{ mmHg}$. The reason is O_2 leaves alveolar air and is added to pulmonary capillary blood and CO_2 leaves pulmonary capillary blood and enters alveolar air on daily bases, O_2 transfer from alveoli equals O_2 consumption by the body, and CO_2 transfer to alveolar air equals CO_2 production.

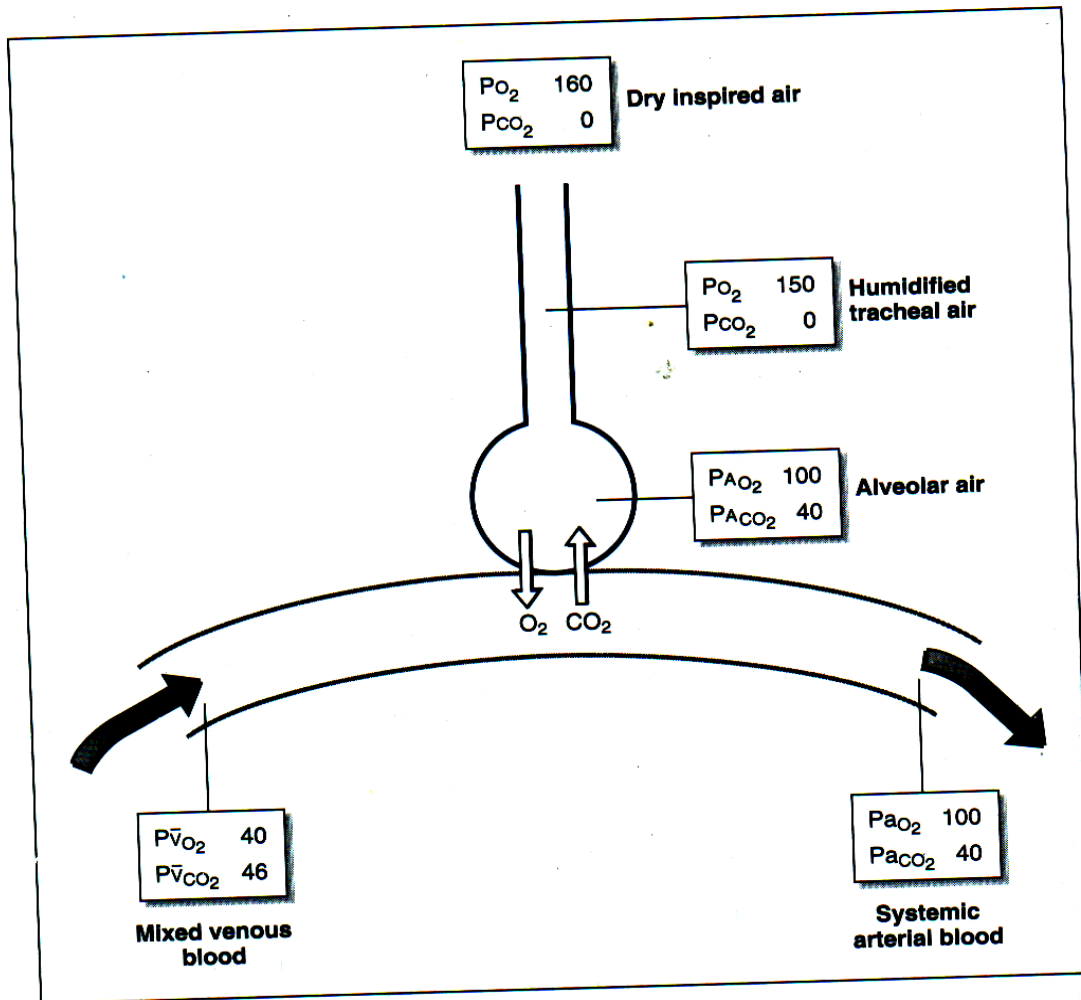

Figure 65. Values for PO_2 and PCO_2 in dry inspired air, humidified tracheal air, alveolar air, and pulmonary capillary blood. The numbers are partial pressures in mmHg. PaO_2 (practical pressure of O_2 in arterial system) is slightly less than 100 mmHg because of physiological shunt.

Blood entering pulmonary capillaries is mixed venous blood. Mixed venous blood $PO_2 = 40$ and $PCO_2 = 46$ mmHg. As blood passes through pulmonary capillaries, exchange of O_2 and CO_2 occurs between alveolar air and pulmonary capillaries. (see fig. 65)

Gas transport in the tissues:

Blood that leaves pulmonary capillaries is arterialized (oxygenated). This blood is systemic arterial blood with,

$PaO_2 = 100\text{mmHg}$

$PaCO_2 = 40\text{ mmHg}$

Thus, it is in complete equilibrium with alveolar air (see figure 61). Normally, PaO_2 is slightly less than PAO_2 due to physiologic shunt. Physiologic shunt refers to the fraction of pulmonary blood flow that bypasses the alveoli, therefore is not arterialized. Thus PaO_2 is normally 95 mmHg. Physiologic shunt is increased in pathologic conditions. This is called Ventilation/perfusion defect. A-a difference expresses difference in PO_2 between alveolar gas (A) and systemic arterial blood (a). If shunt is small, then A-a is small (normal), If abnormal, A-a difference increases.

Figure 66 shows changes in PO_2 and PCO_2 in the lungs. In the tissues, O_2 diffuses from systemic capillaries into tissues and CO_2 from tissues into capillaries, thus PVO_2 (PO_2 in venous blood) = 40 mmHg, whereas, $PVCO_2$ (PCO_2 in venous blood) = 46mmHg. As blood reaches the venous system, PO_2 and PCO_2 changes.

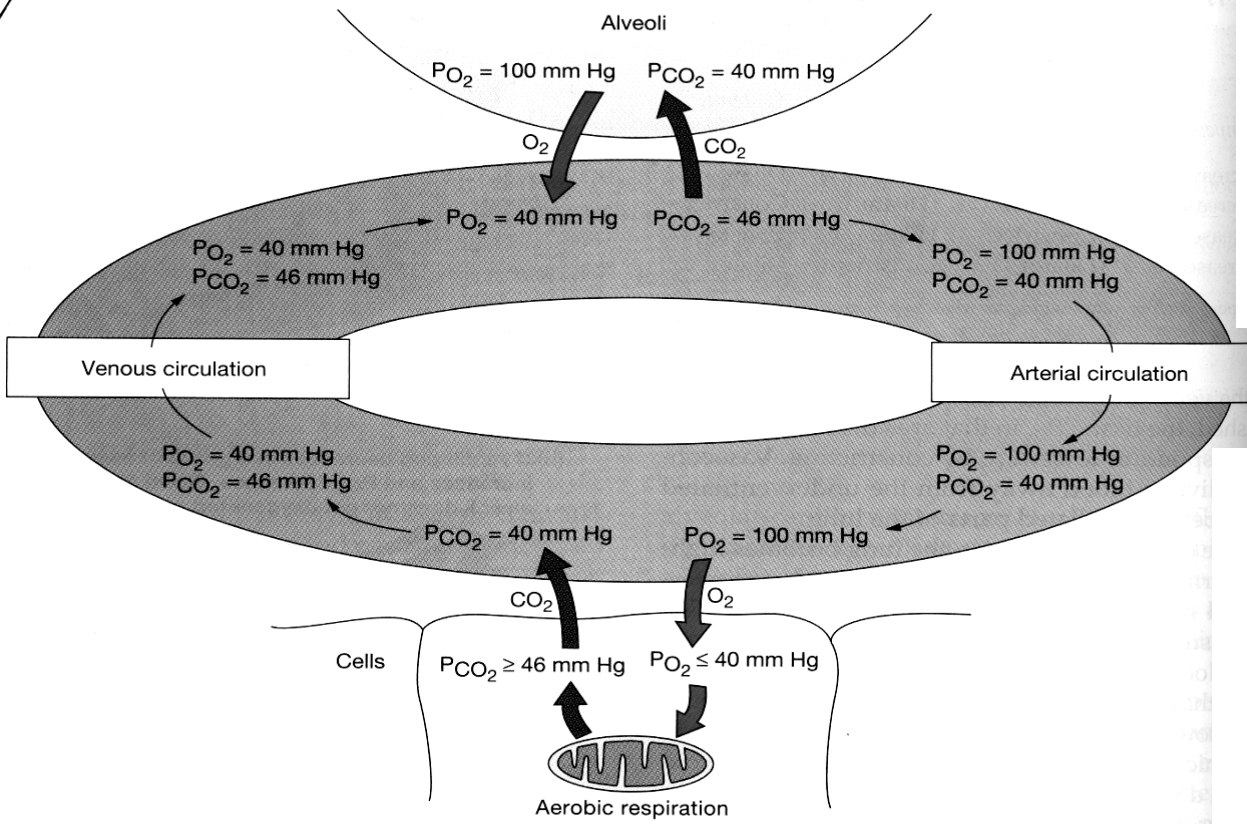

Figure 66. Gas transport to the periphery. Uptake of CO_2 and liberation of O_2 in systemic capillaries. Exactly opposite events occur in the pulmonary capillaries

Oxygen transport in the blood: O₂ is carried in the blood in two forms.

1. Dissolved O₂:

It accounts only 2-3% of the total O₂ content of blood. The solubility of O₂ in blood is 0.003ml O₂/100ml blood/mmHg. Thus for normal PaO₂ of 100mmHg, dissolved O₂ = 0.3ml O₂/100ml (100 mmHg x 0.003 ml O₂/100ml blood/mmHg). The resting O₂ consumption is 250 ml O₂/min. Thus dissolved O₂ is greatly insufficient. Another transport mechanism is thus required.

2. O₂ bound to Hemoglobin (Hb):

97-98% of O₂ is carried bound to Hb. Hb is found inside red cells and has 4 subunits. Each subunit contains heme moiety which is iron-binding porphyrin and polypeptide chain (either α or β). Adult Hb (HbA) has α₂ β₂ (2 of subunits have α chain and 2 have β chain)

Each subunit can bind one molecule of O₂, a total of 4 molecules of O₂ for 1 molecule of Hb. When Hb oxygenated it is called Oxyhemoglobin. When Hb is deoxygenated it is called deoxyhemoglobin. For Hb subunits to bind O₂, the iron in heme moieties must be in ferrous state (Fe²⁺)

Variants of Hb molecule:

Methemoglobin- This is when iron molecule is in ferric (Fe³⁺) state thus doesn't bind O₂.

The cause is due to oxidation of Fe²⁺ to Fe³⁺ by nitrites or sulfonamides. This is a Congenital variant

Fetal Hb (HbF):

In fetal Hb, the two β chains are replaced by γ chains (γ₂ α₂)

HbF has higher affinity for O₂ than HbA, facilitating O₂ movement from mother to fetus.

This Hb is replaced with HbA within the first year of life

HbS: This is abnormal Hb, where α is normal, but β is abnormal. In deoxygenated form, HbS forms sickle-shape in red cells. This deformation result in occlusion of small blood vessels. O₂ affinity of HbS is less than that of HbA.

O₂ binding capacity and O₂- content:

O₂ binding capacity is the maximum amount of O₂ that can be bound to Hb per volume of blood. 1gm Hb binds 1.34 ml O₂. The normal conc. of Hb in blood is 15gm/100ml. Therefore, O₂ binding capacity=20.1ml O₂/100ml blood (15gm/100ml x 1.34 ml O₂ /gm Hb)

$$\begin{aligned} \text{O}_2 \text{ content} &= \text{actual amount of O}_2 \text{ per volume of blood} \\ &= (\text{O}_2\text{-binding capacity} \times \% \text{ saturation of Hb}) + \text{dissolved O}_2 \end{aligned}$$

Where

O₂ content=actual O₂ in blood (ml O₂/100ml blood)

O₂ binding capacity = maximum O₂ bound to Hb
(ml O₂/100 ml blood) at 100% saturation

Percentage saturation= % of heme groups bound to O₂

Dissolved O₂ = un bound O₂ in blood (mlO₂/100ml blood).

O₂-Hb dissociation curve:

Each molecule of Hb binds to 4 molecules of O₂, which is 100% saturation.

If 3 molecules of O₂ bind - 75% saturation

If 2 “ “ “ “ - 50% “

if 1 “ “ “ “ - 25% “

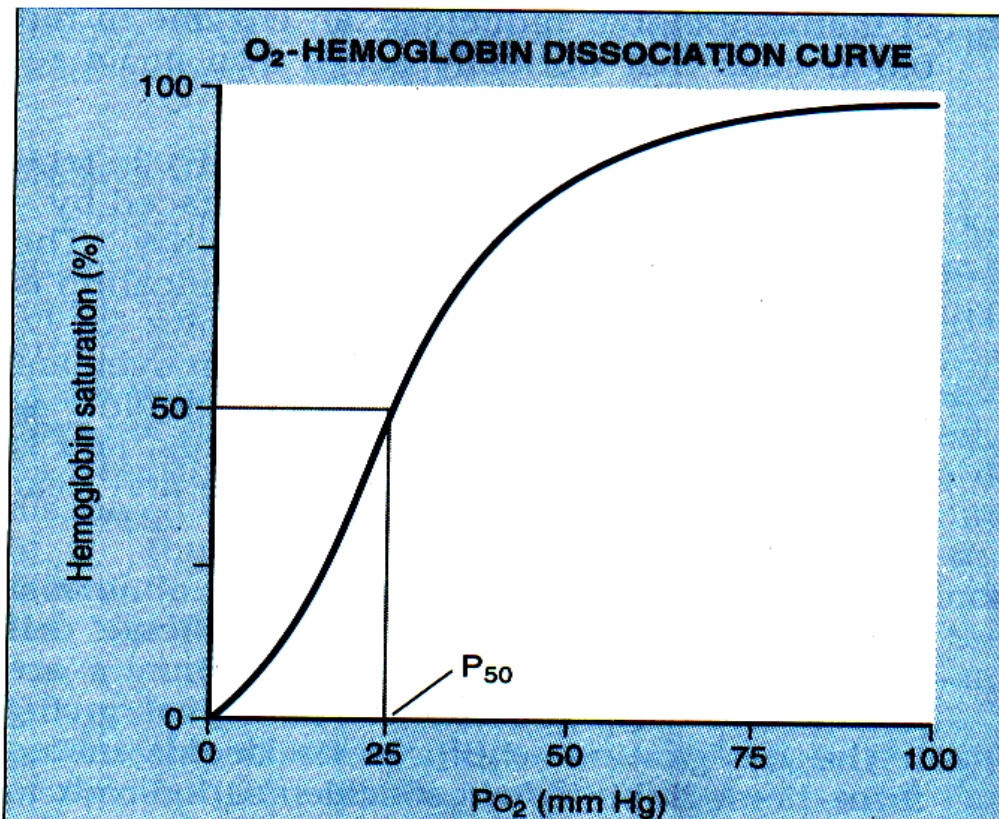

Figure 67. O₂-Hemoglobin dissociation curve P₅₀ is the PO₂ at which Hb is 50% saturated

As shown in figure 67, percent saturation of Hb is the function of PO₂ of blood called O₂-Hb dissociation curve. The curve is sigmoid shape (% saturation of Hb does not increase linearly as PO₂ increases). There is steep increase between 0-40 mmHg PO₂, and levels off between 50-100 mmHg PO₂. The sigmoid shape is a result of change in affinity of heme for O₂. There is positive cooperativity i.e. affinity of heme groups for O₂ increase as each successive O₂ molecule binds. Binding first molecule of O₂ to a heme group increases the affinity for the second O₂ molecule, the second to the third. Highest affinity is to the 4th O₂ molecule

P₅₀ :

Definition: PO₂ at which Hb is 50% saturated. (i.e. where 2 of the four heme groups are bound to O₂). Change in P₅₀ is indicator for change in affinity of Hb for O₂.

Loading and unloading of O₂:

The sigmoid shape of O₂-Hb dissociation curve helps explain: why O₂ is loaded into pulmonary capillary blood from alveoli and unloaded from systemic capillaries into the tissues. At the highest volumes of PO₂ (i.e. in alveolar gas), affinity of Hb for O₂ is highest; at the lower volume of PO₂ (i.e. in mixed venous blood) affinity for oxygen is lower. Alveolar air, pulmonary capillary blood and systemic arterial blood all have a PO₂ of 100mmHg. The graph shown in figure 68 corresponds to 100% saturation and (affinity of Hg for O₂ highest). On the other hand, mixed venous blood has P_{O₂}=40 mmHg (because O₂ diffused from systemic capillaries into tissues), which corresponds to 75% saturation and lower affinity of Hb for O₂

These changes in affinity facilitates- loading of O₂ in lungs (where P_{O₂} and affinity are highest)

-unloading of O₂ in tissue (where P_{O₂} and affinity are lower)

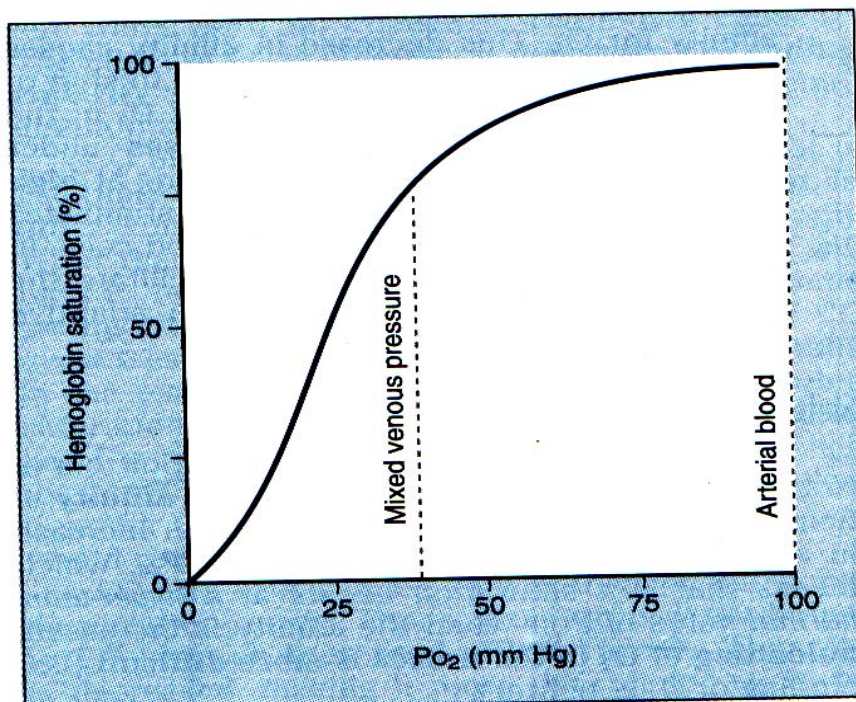

Figure 64. Hb saturation as a function of P_{O₂} in systemic arterial blood and mixed venous blood.

In the lungs:

P_{O_2} is 100mmHg. Hb is nearly 100% saturated. Due to positive cooperativity, affinity of Hb for O_2 is the highest, which corresponds to flat portion of curve (figure 68). $P_{A_{O_2}}$ is higher than $P_{a_{O_2}}$. Therefore, O_2 diffuses into the pulmonary capillary blood. The flat position of curve extends from 100mmHg to 60mmHg (see figure 67). This means, human can tolerate substantial decreases in alveolar P_{O_2} to 60mmHg (e.g. caused by decreases in atmosphere pressure) without compromising the O_2 -carrying capacity of Hb.

In the tissue:

P_{O_2} is 40mmHg. Hb is 75% saturated and the affinity for O_2 is decreased. O_2 is not tightly bound which facilitates unloading of O_2 in the tissues. Partial pressure gradient for O_2 diffusion into tissue is maintained in two ways:

- Tissues consume O_2 keeping P_{O_2} low
- Low affinity for O_2 insures O_2 will be unloaded from Hb

Thus O_2 diffusion from blood to tissues maintained.

Changes in the O_2 -Hb dissociation curve:

Shift to the right:

Occur when there is decreased affinity of Hb for O_2 (see figure.69). P_{50} increases and unloading of O_2 in the tissues is facilitated.

Factors causing right shift:

Increases in PCO_2 and decreases in pH: When metabolic activity of the tissues increase production of CO_2 increases. An increase in tissue PCO_2 causes an increase H^+ and a decrease pH. This mechanism ensures that O_2 delivery to the tissues can meet O_2 demand (e.g. in exercising skeletal muscle).

Bohr effect states that an increased H^+ concentration causes a right shift of the O_2 -Hb dissociation curve which causes Hb to unload O_2 more readily in the tissues.

Increases in temperature. Increases in temperature also cause right shift, and facilitate unloading of oxygen in the tissues.

Increases in 2, 3 diphosphoglycerate (2,3-DPG) concentration.

2,3-DPG binds to β -chains of deoxyhemoglobin and reduces their affinity for O_2 . This decrease in affinity causes right shift and facilitates unloading of oxygen in the tissues. 2,3-DPG production increases under hypoxic conditions. Eg. high altitude causes hypoxemia, which stimulates production of 2,3-DPG in red cells. This facilitates O_2 delivery to the tissues as adaptive mechanism



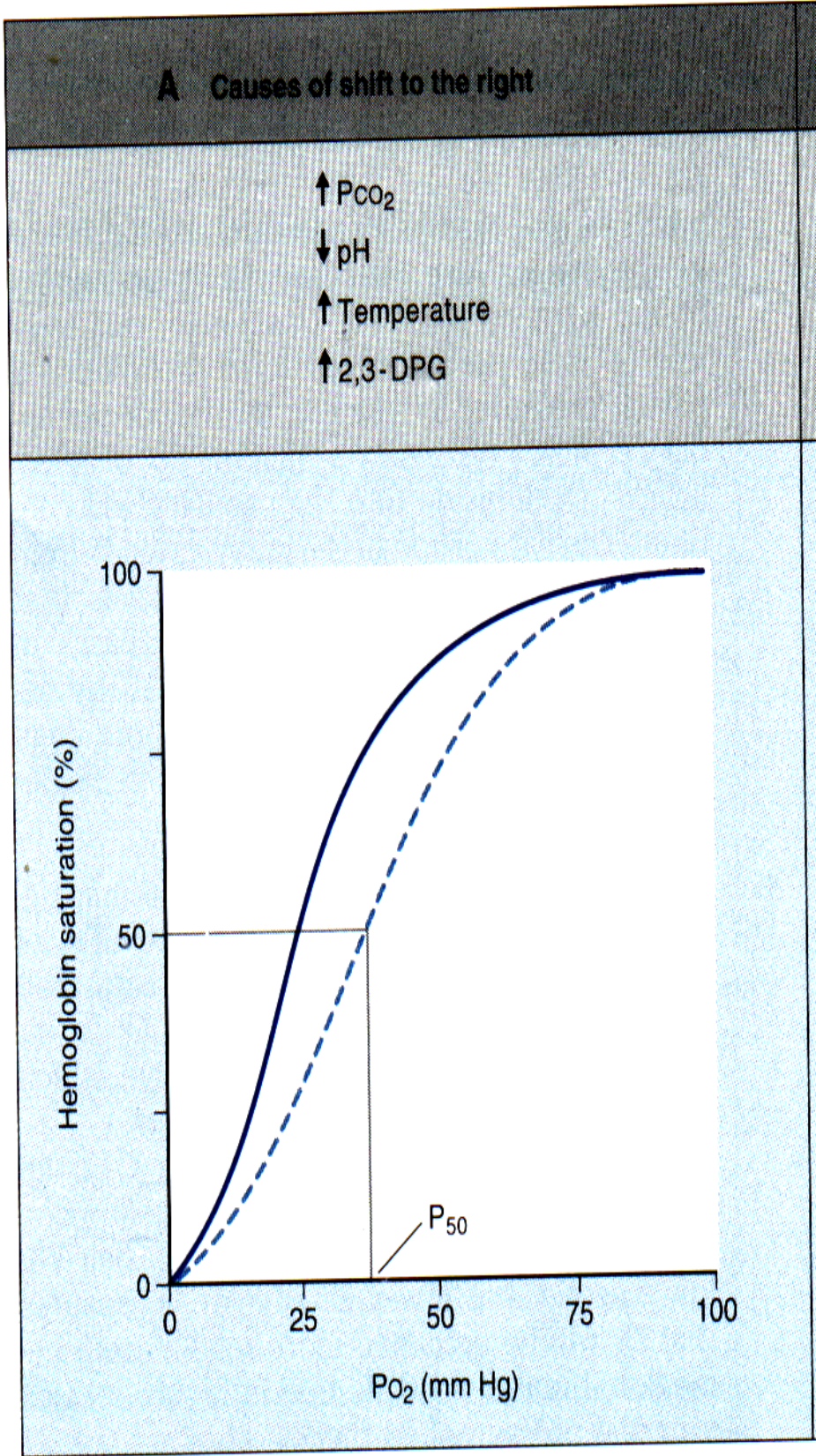

Figure 69 A. shift of the O_2 -Hb dissociation curve.

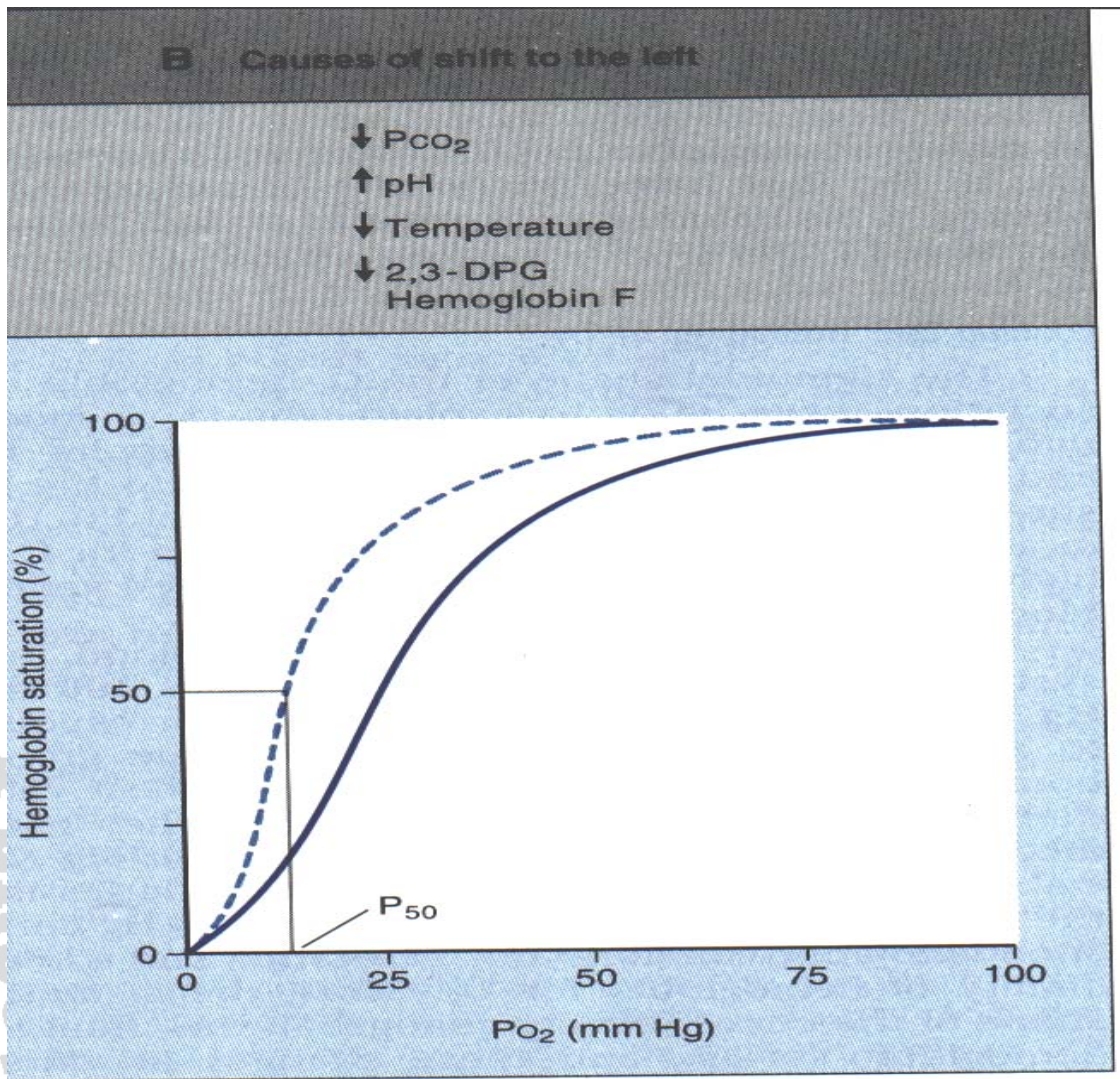

Figure 69 B. shift of the O_2 -Hb dissociation curve.

Shift to the left:

This occurs when the affinity of Hb for oxygen increases. An increase in affinity is reflected in a decrease in P_{50} (50% saturation occurs at lower than normal value of P_{O_2}). When the affinity is increased unloading of O_2 in tissue is more difficult

Decrease in PCO_2 and increases in pH:

When tissue metabolism decrease. CO_2 production and H^+ conc. decreases. Thus, when O_2 demand decreases, O_2 unloading to tissue decreases.

Decreases in temperature:

When tissue metabolism decreases, less heat is produced and less O_2 is unloaded to the tissues.

Decrease in 2,3-DPG concentration:

This reflects decreased tissue metabolism, causing a left shift of the curve and less oxygen to be unloaded in the tissues.

Carbon monoxide (CO) poisoning:

All the effects on the oxygen-hemoglobin dissociation curve discussed above have involved right or left shifts, with no change in oxygen binding capacity. The effect of CO is different: it decreases O_2 -binding capacity and also causes left shift (see figure 70). Co binds to Hb with affinity 250 times that of O_2 .

$Co+Hb =$ carboxyhemoglobin (COHb.)

In the presence of CO, O_2 can't bind to heme group that are bound to CO. Thus O_2 -binding capacity of Hb decreases. The final effect is decreased O_2 delivery to the tissues. CO also causes left shift, because heme not bound to CO have increased affinity for O_2 . P_{50} decreased, and unloading becomes difficult.

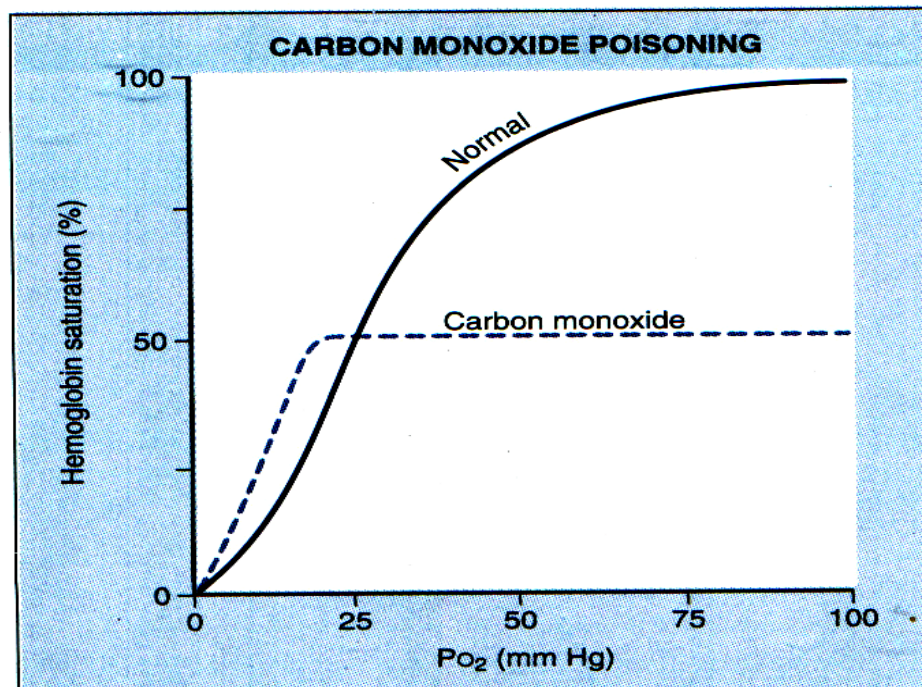

Figure 70. Effect of carbon monoxide on the oxygen-hemoglobin dissociation curve.

Carbon dioxide transport:

Dissolved CO₂:

About 5% of the total CO₂ in the blood is transported dissolved.

Solubility of CO₂ = 0.03mlCO₂/100ml blood/mmHg.

Dissolved CO₂ in arterial blood = 40mmHg x 0.03mlCO₂/100ml blood/mmHg)
= 1.2ml/100ml blood

Carbamino hemoglobin

CO₂ binds to terminal aminogroups on proteins (eg. Hb and plasma proteins such as albumin). When CO₂ is bound to Hb, it is called carbaminohemoglobin, which accounts for about 3% of the total CO₂.

HCO₃⁻

Almost all of the carbondioxide carried in the blood is in chemically modified form, HCO₃⁻ which accounts for ~ 90% of the total CO₂.

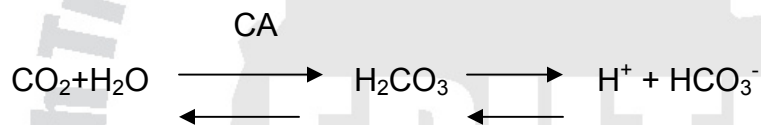

The reaction is catalyzed by an enzyme called carbonic anhydrase (CA) in red cells. In the tissues, CO₂ generated from aerobic metabolism is converted to HCO₃⁻ and transported to the lungs. In the lungs, HCO₃⁻ is reconverted to CO₂ and expired. Figure 71 shows the steps occurring in systemic capillaries.

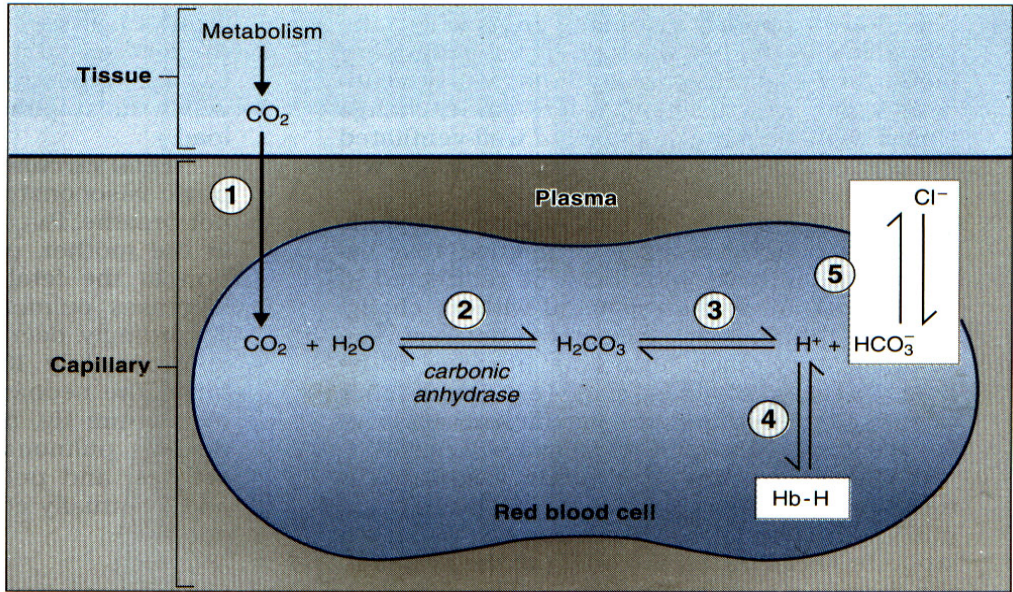

Figure 71. Transport of CO₂ in blood, CO₂ and H₂O are converted to H⁺ and dHCO₃⁻ inside red cells. H⁺ is buffered by Hb- inside RBC. HCO₃⁻ exchanges for Cl⁻ and is transported in plasma. The numbers in the figure correspond to explanation in the text below.

The circled numbers shown in the figure correspond with the following steps.

1. In the tissues, CO₂ is produced from aerobic metabolism.

CO₂ then diffuses into RBC (derived by partial pressure gradient for CO₂)

2. CA found in high concentration in RBC catalyzes the hydration of CO₂ to form H₂CO₃.

3. In the RBC, H₂CO₃ dissociates into H⁺ +HCO₃⁻. The H⁺ remains in RBC where it will be buffered. HCO₃⁻ is transported into the plasma in exchange for Cl⁻

4. H⁺ is buffered in RBC by deoxyhemoglobin and is carried in venous blood in this form. By the time blood reaches the venous end of the capillaries Hb is conveniently in its deoxygenated form (i.e. it has released its O₂ to the tissues). There is a useful reciprocal relationship between the buffering of H⁺ by deoxyhemoglobin and the Bohr effect. Thus the H⁺ generated from the tissue CO₂ causes hemoglobin to release O₂ more readily to the tissues. In turn, deoxygenation of HB makes it better buffer for H⁺

5. The HCO_3^- produced is exchanged for Cl^- (to maintain charge balance).

Cl^- HCO_3^- exchange is called Cl^- shift (chloride shift). In the lungs the reaction is reversed (not shown in figure 13). When RBC enters pulmonary capillaries, O_2 diffuses into cell and combines with Hb, which releases CO_2 (Haldane effect)

Control of breathing:

Brainstem control of breathing. (see fig 72 & 73)

Breathing is an involuntary process that is controlled by the medulla and pons of the brainstem. The frequency of normal, involuntary breathing is controlled by three groups of neurons or brainstem centers.

- modularly respiratory center: are located in the reticular formation, and are composed of Inspiratory center (dorsal respiratory group) and Expiratory center (Ventral respiratory group)
- The Inspiratory center controls basic rhythm by setting the frequency of inspiration. This group of neurons receives sensory input from Peripheral chemoreceptors via glossopharyngeal (CN IX) and Vagus (CN X) and from mechanoreceptors in lung via the vagus nerve

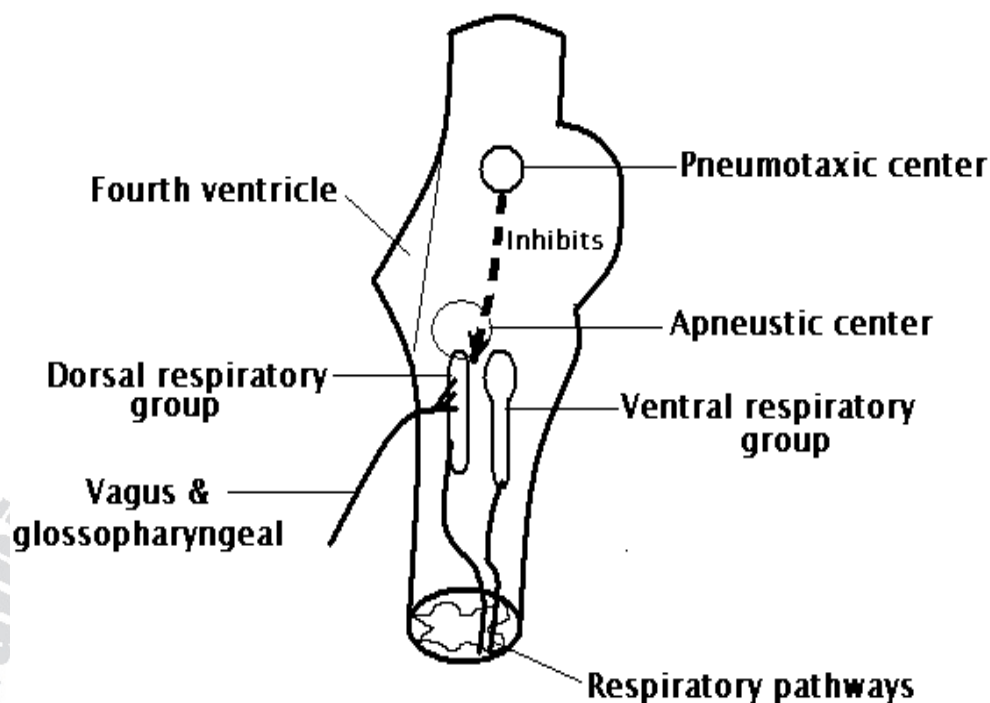

Figure 72. Organization of the respiratory center

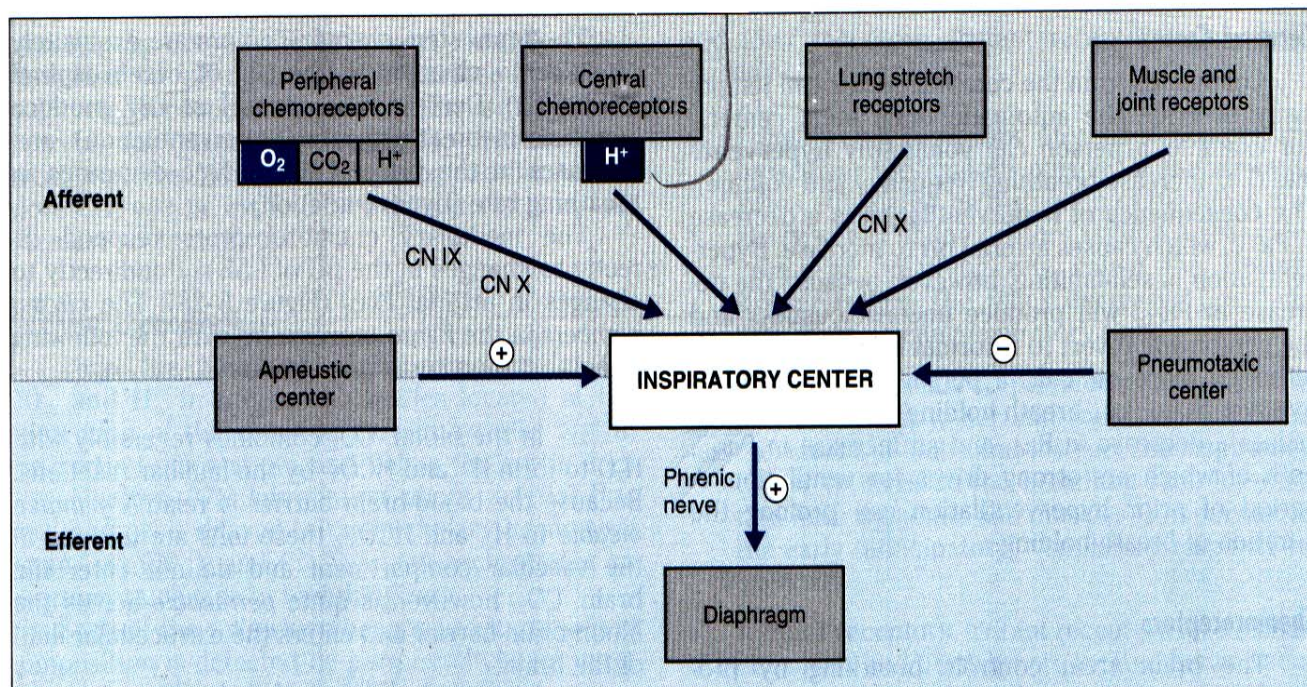

Figure 73. Brainstem control of breathing. Afferent (sensory) information reaches the medullary inspiratory center via central and peripheral chemoreceptors and via

mechanoreceptor. Efferent (motor) information is sent from inspiratory center to the phrenic nerve, which innervates the diaphragm. CN, Cranial nerve.

Inspiration is shortened by inhibition of inspiratory center via the pneumotaxic center (see below)

- Expiratory center (see figure 68) is located in the ventral respiratory neurons and is responsible primarily for expiration. Since expiration is normally a passive process, these neurons are inactive during quiet breathing. However, during exercise when expiration becomes active, this center is activated
- Apneustic Center. Apneusis is an abnormal breathing pattern with prolonged inspiratory gasps, followed by brief expiratory movement. Stimulation of apneustic center in the lower pons excites the inspiratory center in the medulla, prolonging the contraction of the phrenic nerve. If the lower pons is affected in brain injury, apneusis can occur.
- Pneumotaxic center is located in the upper pons and turns off inspiration limiting the size of TV and secondarily it regulates respiratory rate. Normal breathing rhythm persists in the absence of these centers

Cerebral cortex:

Commands from the cerebral cortex can temporarily override automatic brainstem centers.

For example, a person can voluntarily hyperventilate (i.e. increase breathing frequency and volume). The consequence of hyperventilation is a decrease in PaCO_2 and an increase in arterial pH. The decrease in PaCO_2 will produce unconsciousness and the person reverts to normal breathing pattern. A person may voluntarily hypoventilate (breath holding). Hypoventilation decreases PaO_2 and increases PaCO_2 , both of which are strong drives for ventilation. A period of prior hyperventilation can prolong the duration of breath holding.

Chemoreceptors:

The brain stem controls breathing by processing sensory (afferent) information and sending motor (efferent) information to the diaphragm. The most important sensory information is PaO_2 , PaCO_2 and arterial pH.

Central chemoreceptors:

They are located in the brain stem (ventral surface of medulla) and are important for minute-to-minute control of breathing. They communicate directly with the inspiratory center

The receptors are mainly sensitive to changes in pH of cerebrospinal fluid (CSF). Decreases in the pH of CSF, produce increases in breathing rate (hyperventilation), and increases in pH of CSF produce decreases in breathing rate (hypoventilation)

The medullary chemoreceptors respond directly to changes in the pH of CSF and indirectly to changes in arterial PCO_2 . Therefore, the goal of central chemoreceptors is to keep arterial PCO_2 within normal range.

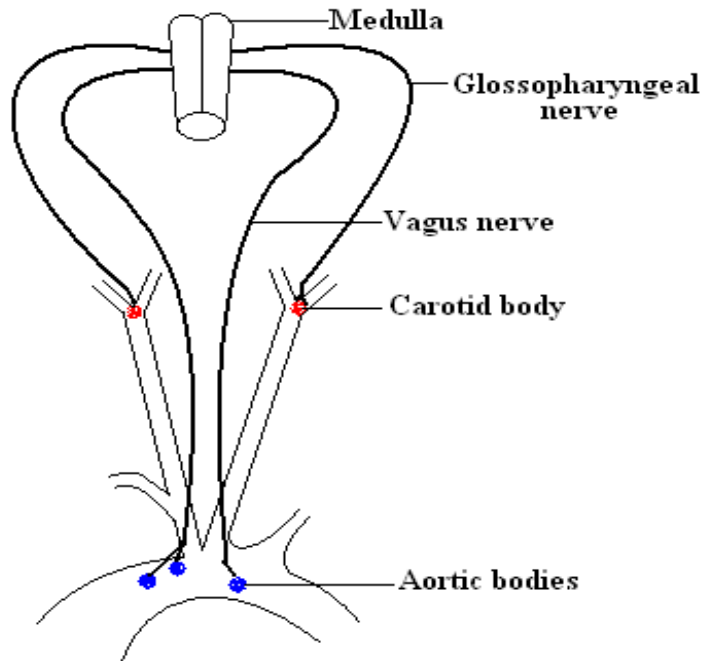

Figure 74: Respiratory control by peripheral chemoreceptors in the carotid and aortic bodies

Peripheral chemoreceptors: (see fig. 74)

- **Carotid bodies:** Located at bifurcation of common carotids. They respond to decrease in arterial P_{O_2} and pH and to increase in PCO_2
- **Aortic bodies** – located above and below the aortic arch. They respond to increased level of CO_2 . Changes in PO_2 , PCO_2 and pH of arterial blood are also controlled by these receptors.

Decrease in arterial PO_2 (PaO_2): There is no response to changes in PaO_2 between 60 -100mmHg. If $PaO_2 < 60$ mm Hg, breathing rate increases in a steep and linear fashion. Increases in $PaCO_2$. Peripheral chemoreceptors detect increases in $PaCO_2$, but the effect less

Decrease in arterial pH: Mediated by carotid bodies (not aortic bodies)

In metabolic acidosis (due to decreased arterial pH), ventilation rate increases.

Other receptors:

Lung stretch receptors:

These are mechanoreceptor in smooth muscle of the airways. The stimulus is

distension of lungs and air ways. The response is reflex decrease in breathing rate (Hering Breuer reflex). This reflex decreases breathing by prolonging the expiratory time.

Joint and muscle receptors: They are located in joints and muscles and detect movement of limbs. Instruction is given to the inspiratory centers to increase breathing rate

Irritant receptors:

Their location is between epithelial cells lining the airway. They are stimulated by noxious chemicals and particles

The response is reflex constriction of bronchial smooth muscles and increase in breathing rate

J- Receptors (Juxtacapillary receptors): These receptors are found in the alveolar walls (thus near capillaries). The stimulus is engorgement of pulmonary capillaries with blood and increase in interstitial fluid volume. The response is increase in breathing rate

For example, in left heart failure blood “backs up” in pulmonary circulation, and J receptors mediate change in breathing pattern including rapid shallow breathing and dyspnea (difficulty in breathing)

General and Cellular nonrespiratory lung function

Filtration:

filter out small blood clots (small pulmonary emboli)

Immunologic: bronchial secretion contains Immuno globulin (IgA)

Alveolar macrophages are phagocytic and remove bacteria and small particles inhaled by lungs. Macrophages also function in attraction of polymorpho nuclear leukocytes, release Vasoactive and chemo tactic substances.

Fibrinolytic system in lungs lyses clots in pulmonary veins.

Endocrine function: The lungs produce factor VIII, surfactant, and are involved in the conversion of Angiotension I to Angiotensin II by converting enzyme. Synthesis of prostaglandins, histamine and kallikern are made in the lungs.

Hypoxia

If the oxygen content of the blood is reduced, there may be insufficient O_2 to support the aerobic metabolism of the tissues. This condition is known as hypoxia. Hypoxia, if severe enough, can cause death of cells throughout the body. In less severe degree it results:

- (1) **Depressed mental activity**, sometimes culminating in coma.
- (2) **Reduced work capacity of the muscles.**

Types of hypoxia

Depending on the cause, hypoxia is generally divided into four categories- hypoxic, anemic, stagnant, and histotoxic

(1) Hypoxic hypoxia

(a) Low alveolar P_{O_2}

If the alveolar P_{O_2} is low the arterial P_{O_2} will inevitably follow and so will O_2 content. As a result, or O_2 is extracted from the blood to support the oxidative metabolism of the tissues. This is quite common following ascent to high altitude as the barometric pressure and P_{O_2} falls with increasing altitude.

(b) Reduced ventilation (Hypoventilation)

Hypoventilation will lead to a reduced alveolar P_{O_2} and an increased P_{CO_2} (hypercapnia).

Examples

- ***Respiratory depression due to drug overdose (barbiturate poisoning)***
- ***Severe weakness of the muscles that support respiration e.g. myasthenia gravis***
- ***Airway obstruction***

(c) Reduced diffusing capacity

Examples

- ***Fibrosis of the lung parenchyma***
- ***Pulmonary edema***

(d) Low ventilation-perfusion ratio

If the ventilation-perfusion ratio ($V_A:V_Q$) is low in a significant portion of the lung, this will lead to hypoxic hypoxia.

(e) Arteriovenous shunt

A right-left shunt will allow some venous blood to bypass the lungs completely. Although the hemoglobin of the unshunted blood (i.e. that which has bypassed through the alveoli) is virtually fully saturated, the shunted blood will have the same P_{O_2} as mixed venous blood.

As a result, the P_{O_2} and O_2 content of the blood in the systemic arteries are reduced.

(2) Anemic hypoxia

This is due to a decrease in O_2 carrying capacity of blood. It is caused by a decrease in the amount of hemoglobin available for binding of O_2 so that the O_2 content of the arterial blood is abnormally low. The major reasons of anemic hypoxia are:

- ***Reduced erythropoiesis***
- ***Blood loss***
- ***Synthesis of abnormal hemoglobin***
- ***Carbon monoxide poisoning***

(3) Stagnant hypoxia

If the blood flow through a tissue is sluggish, blood would stay in the capillaries for a longer time than the normal. Therefore, the blood will have to meet the oxygen requirements of the tissue for a longer time. The stay of blood in the capillaries may be so long that even after extracting a very large fraction of O_2 carried by the blood, all the requirements of the tissue cannot be met.

Examples:

- ***Reduced cardiac output: cardiac failure, hemorrhage, circulatory shock***
- ***Local vasoconstriction: exposure of the extremities to the cold***

(4) Histotoxic hypoxia

If the tissues are unable to use oxygen brought to them by blood, even that results in hypoxia. Histotoxic hypoxia refers to poisoning of the oxidative enzymes of the cells. In this situation the supply of O_2 to the tissues is normal but they are unable to make full use of it. As a result the venous

P_{O_2} is abnormally high.

Examples:

- **Cyanide poisoning**
- **Beriberi**

Oxygen therapy

Oxygen therapy may be required for respiratory failure due to lung disease or poisoning.

Methods of oxygen administration

Oxygen may be administered in many ways:

(1) Cannula (intranasal tube)

The simplest way is to connect a cannula to an oxygen cylinder and insert it into one or both nostrils. This raises the concentration of oxygen in the inspired air but generally not to 100%, which may be a boon if the hypoxic drive is important to maintain the ventilation of the patient.

(2) Mask

By this method the patient is allowed to breathe either pure oxygen or high concentrations of oxygen from a mask.

(3) Oxygen tent

This is especially useful for children, who may not tolerate a mask or a cannula. It is also useful if hyperbaric oxygen is to be given. But fire is a serious hazard associated with the oxygen tent.

(4) Mechanical ventilator

Another method for giving oxygen is through a mechanical ventilator. Patients who remain unconscious for fairly long periods of long time are given an **endotracheal or tracheostomy tube**, which are connected to a ventilator.

Effectiveness of hypoxia in different types of hypoxia

Oxygen therapy is very useful in some types of hypoxia, may have some value in some types, whereas, in some cases it is not useful at all.

(1) Hypoxic hypoxia

Oxygen therapy is useful in all the forms of hypoxia excepting shunts.

(a) Atmospheric hypoxia: In atmospheric hypoxia, oxygen therapy can correct completely the depressed oxygen level in the inspired gases, and, therefore, provide 100% effective therapy.

(b) Hypoventilation hypoxia: In hypoventilation hypoxia, a person breathing 100% oxygen can move five times as much oxygen into the alveoli with each breath as when breathing normal air.

Therefore, here again oxygen therapy can be extremely beneficial.

(c) Hypoxia caused by impaired alveolar membrane diffusion: Essentially the same result occurs as in hypoventilation hypoxia, because oxygen therapy can increase the P_{O_2} in the lungs from a normal value of about 100mmHg to as high as 600mmHg. This raises the oxygen pressure gradient for diffusion between the alveoli and the blood from the normal value of 60mmHg to as high as 560mmHg, an increase more than 800%.

(d) Arteriovenous (or physiologic) shunt: In shunts, admixture is after oxygenation in the lungs.

Hence oxygen therapy does not help.

(2) Anemic hypoxia

In anemic hypoxia, the oxygen therapy has some value although not much, because oxygen is available in the alveoli. Even so, a little amount of extra oxygen, between 7 and 30%, can be transported in the dissolved state in the blood when alveolar oxygen is increased to maximum even though the amount transported by the hemoglobin is hardly altered. This small amount of extra oxygen may be the difference between life and death.

(3) Stagnant hypoxia

Oxygen therapy has very little value in this type of hypoxia.

(4) Histotoxic hypoxia

In this type of hypoxia, the tissue metabolic enzyme system is simply incapable of using the oxygen that is delivered. Therefore, oxygen therapy is of hardly any measurable benefit.

Cyanosis

The term cyanosis means blueness of the skin, and its cause is excessive amounts of deoxygenated hemoglobin in the skin blood vessels, especially in the capillaries.

This deoxygenated hemoglobin has an intense dark blue-purple color that is transmitted through the skin. In general, definite cyanosis appears whenever the arterial blood contains more than 5g deoxygenated hemoglobin in each 100ml of blood. The common sites where cyanosis is observed are **lips, nailbeds, ear lobes, cheeks,** and **mucous membranes of the oral cavity.**

A person with **anemia** almost never becomes cyanotic because there is not enough hemoglobin for 5g to be deoxygenated in 100ml of arterial blood. Conversely, in a person with excess red blood cells, as occurs in **polycythemia vera**, the great excess of available hemoglobin that can become deoxygenated leads frequently to cyanosis, even under otherwise normal conditions.

Disorders of the respiratory system

Pulmonary edema

Pulmonary edema refers to the condition in which fluid accumulates in the interstitial spaces and alveoli of the lungs. Acute pulmonary edema is a life-threatening condition

Causes

- (a) Left heart failure:
- (b) Infectious agents, toxic gases, and drug reactions
- (c) Rapid infusion of intravenous fluids or a blood transfusion

Chronic obstructive pulmonary diseases (COPD)

The term chronic obstructive pulmonary disease (COPD) denotes a group of respiratory disorders characterized by small airway obstruction and reduction in expiratory flow rate. The most prevalent of these disorders are **emphysema** and **chronic bronchitis**. Other forms of COPD are **bronchiectasis** and **cystic fibrosis**. Since the most common cause of COPD is smoking, the disease is largely preventable. Unfortunately, clinical findings are completely absent during the early stages of the COPD and by the time, symptoms appear, the disease is usually well advanced. The mechanisms of airway obstruction in COPD are usually multiple, which include a reduction in the elasticity of the lung structures, bronchoconstriction, and chronic inflammation. In COPD the time required for FVC is increased, the FEV_{1.0} is decreased, and FEV_{1.0}/FVC is decreased.

These and other measurements of expiratory flow are determined by spirometry and are used in the diagnosis of COPD.

Emphysema

Emphysema is characterized by a loss of lung elasticity and abnormal dilation of the air spaces distal to the terminal bronchioles with destruction of the alveolar walls and capillary beds.

There is hyperinflation of the lungs, and breath sounds are decreased.

Chronic bronchitis

In chronic bronchitis airway obstruction is caused by inflammation of both major and small airways. It is more common in men than in women, but changing smoking habits may soon change this disproportion. It usually first appears in the fourth to fifth decades of the life.

Causes

(1) **Smoking and pollutants**

(2) **Infections:** Viral and bacterial infections are common and are thought to be result than a cause of the problem.

Asthma

Asthma is characterized by spastic contraction of the bronchiolar smooth muscles, which causes extremely difficult breathing. It is a disease characterized by intermittent attacks of dyspnea and wheezing caused by paroxysmal narrowing of the bronchial airways. The FRC and the RV of the lung become greatly increased during the asthmatic attack because of the difficulty in expiring air from the lungs. Asthma occurs in 3 to 5% of the population at some time in life.

Alterations in breathing patterns

Dyspnea

Dyspnea is a subjective sensation of difficulty in breathing. The terms **dyspnea**, **breathlessness**, and **shortness of breath** are often used interchangeably. It is often associated with respiratory diseases, but it can occur in healthy individuals also.

Dyspnea in disease

Dyspnea is observed in at least three different cardiopulmonary disease states:

- (a) **Primary lung diseases:** such as *pneumonia*, *asthma*, and *emphysema*
- (b) **Heart disease:** *Pulmonary edema*
- (c) **Neuromuscular disorders:** *myasthenia gravis* and *muscular dystrophy of the respiratory muscles*.

Dyspnea in healthy individuals

(a) **Exercise:** In healthy individuals dyspnea occurs during exercise, particularly in untrained individuals.

(b) **High altitude:** It is also common in subjects who have rapidly climbed to a high altitude.

(c) **Emotional or neurogenic dyspnea:** In neurogenic dyspnea or emotional dyspnea, the person's respiratory functions may be normal and still dyspnea may be experienced because of an abnormal state of mind. This feeling is greatly enhanced in people who have a psychological fear of not being able to receive a sufficient quantity of air, such as in entirely small or crowded rooms.

Periodic breathing

An abnormality of breathing called periodic breathing occurs in a number of disease conditions.

The person breathes deeply for a short interval of time and then breathes slightly or not at all for an additional interval. Thus the cycle repeats itself over and over again.

Cheyne -Stokes breathing

The most common type of periodic breathing is Cheyne-Stokes breathing, is characterized by slowly waxing and waning respiration, occurring over and over again every 45 seconds to 3 minutes.

Occurrence in disease:

(a) Congestive heart failure and uremia: Cheyne-Stokes breathing is commonly found in congestive heart failure and uremia.

(b) Brain disease: It also occurs in patients with brain disease.

Occurrence in healthy individuals:

(a) Sleep

(b) High altitude

(c) Infancy

Causes

Cheyne-Stokes breathing is due to sluggishness of chemical regulation of respiration. The result is alternate apnea and hyperventilation.

